

-12460  
RECEIVED  
AUG - 9 2021  
Humboldt County  
Cannabis Svcs.

# SITE MANAGEMENT PLAN

In fulfillment of  
Order WQ 2017-0023-DWQ  
General Waste Discharge Requirements for Discharges of Waste Associated with  
Cannabis Cultivation Activities

Prepared for:  
**New Earth Farms, LLC - Willow Creek**  
**APN: 522-024-001**  
and  
California State Water Resources Control Board



**Tier 2, Low Risk Discharger**  
**WDID: 1B171776CHUM**



Prepared by:

**NORTHPOINT**  
CONSULTING GROUP, INC.

Greyson Adams  
[greyson@northpointeureka.com](mailto:greyson@northpointeureka.com)

707-798-6438

July 2019

## TABLE OF CONTENTS

INTRODUCTION

SITE INFORMATION

TIER AND RISK DESIGNATION

BEST PRACTICAL TREATMENT OR CONTROL (BPTC) MEASURES

1. Sediment Discharge Measures
  - 1.1. Site Characteristics
    - 1.1.1. Site Map
    - 1.1.2. Road Conditions
    - 1.1.3. Water Bodies, Stream Crossings, Riparian Setbacks
    - 1.1.4. Soil Disturbance
  - 1.2. Sediment Erosion Preventions and Sediment Capture
    - 1.2.1. Erosion Prevention BPTC Measures
      - 1.2.1.1. Roads
      - 1.2.1.2. Disturbed Areas
      - 1.2.1.3. Streams and Stream Crossings
      - 1.2.1.4. Winterization
    - 1.2.2. Sediment Capture BPTC Measures
      - 1.2.2.1. Roads, Stream Crossings, and Soil Disturbance
    - 1.2.3. Maintenance Activities – Erosion Prevention and Sediment Control
      - 1.2.3.1. Monitoring
      - 1.2.3.2. Maintenance
2. Fertilizer, Pesticide, Herbicide, and Rodenticide BPTC Measures
  - 2.1. Cultivation Product Storage, Use, and Disposal
    - 2.1.1. Storage
    - 2.1.2. Application
    - 2.1.3. Disposal and Spill Prevention/Cleanup
3. Petroleum Product BPTC Measures
  - 3.1. Petroleum Storage, Use, and Disposal
    - 3.1.1. Storage
    - 3.1.2. Application
    - 3.1.3. Disposal and Spill Prevention/ Cleanup
4. Trash/Refuse and Domestic Wastewater BPTC Measures
  - 4.1. Household Trash and Cultivation-related Waste
  - 4.2. Residents, Employees, and Visitors
    - 4.2.1. Domestic Wastewater – Generation



#### 4.2.2. Domestic Wastewater – Disposal

### 5. Winterization BPTC Measures

#### 5.1. Activities and Maintenance

##### 5.1.1. Roads and Stream Crossings

##### 5.1.2. Disturbed Areas

##### 5.1.3. Storage and Stockpiled Materials

###### 5.1.3.1. Cultivation-related Products and Waste

###### 5.1.3.2. Vehicles, Machines, and Petroleum Products/Waste

###### 5.1.3.3. Stockpiled Materials

## **APPENDICES**

Appendix A: Site Map

Appendix B: Disturbed Area Map

Appendix C: BPTC Implementation and Maintenance Schedule

Appendix D: BPTC Measure Specifications

Appendix E: References

Appendix F: Water Use Records

Appendix G: Fertilizer, Pesticide, Herbicide, and Rodenticide Product List and Records

Appendix H: Monthly BPTC Monitoring and Maintenance Records

## INTRODUCTION

This Site Management Plan (SMP) has been developed to satisfy the requirements of the Tier 2 enrollment conditions in the State Water Resource Control Board (SWRCB) Order No. WQ 2017-0023-DWQ (Order). The purpose of the Order is to implement the Cannabis Policy requirements for waste discharges associated with cannabis cultivation. The Policy provides a structure for managing water quality and instream flow impacts associated with cannabis cultivation. It also establishes criteria for personal use and site conditional exemptions and includes a tiered approach for permitting discharges of waste. All eligible dischargers developing land for cannabis cultivation activities are required to enroll in the program under the Order. Dischargers must implement Best Practical Treatment or Control (BPTC) measures and submit technical and monitoring reports to assure compliance with the Order. The SMP describes how the discharger is complying with the applicable BPTC measures listed in the Policy and how they are being implemented property-wide.

---

## SITE INFORMATION

**Registrant:** New Earth Farms, LLC.  
P.O. Box 470  
Salyer, CA, 95563

**Site**

**Address:** Old 3-Creeks Road, Willow Creek, CA, 95573

**Parcel:** Assessor Parcel Number: 522-024-001  
Lat/Long: 40.982306°, -123.730721°

**Zoning:** General Plan: T (Timberland)  
Use code description: Timberland  
Zone: TPZ (Timber Production Zone)

**Acreage:** 522-024-001 (320 acres assessed as per Humboldt County)  
±318.89 acres as per Humboldt County Web GIS  
Total Disturbed Area = 66,483 sf (1.53 acres)

**Location:** The project site is located off of Old 3-Creeks Road in the Willow Creek Area, CA. From Blue Lake, CA, take Highway 299 east for approximately 22.1 miles before arriving at Old 3 Creeks Road. Travel up Old 3 Creeks road for approximately 4.2 miles before taking the split to Buck Buttes (stay to the right). Continue on Old 3 Creeks Road for another 1.3 miles before coming to a locked gate on the right-hand side. Continue through the locked gate for another 2.58 miles before arriving at a locked gate on the Project Site.



**Site Description:** The property spans a mid-slope setting and occupies a parcel historically utilized for timber production. There are multiple watercourses which flow through the parcel, all of which drain to Supply Creek, a Class I watercourse. The enrolled property consists of a single parcel, APN: 522-024-001 (320 acres as assessed), hereafter referred to as the “Project Site”. The parcel comprising the Project Site runs east to west approximately 4,940-feet by 2,790-feet north to south.

The Project Site is zoned for the production of timber (TPZ) and is primarily comprised of forested lands. The forested lands are principally composed of Douglas fir with some other coniferous species covering approximately 95% of the Project Site. Observed Deciduous species include Big Leaf Maples and California Bay. Cultivation activities are located outside of riparian areas and occur exclusively on legacy logging landings appurtenant to the pre-existing road network. These landings and roads were historically utilized for logging and timber production purposes. Buildings on the Project Site include a storage / drying building (approximately 770 square feet (sf)) and a well pump house (64 sf). The parcel relies on petroleum powered generators for production of all needed power for cultivation related activities. The Project Site is at an average elevation of 3,500-feet above sea level. The climate is characterized by hot dry summers and cool winters with seasonal snow fall. Rainfall for the region averages 127-inches per year as measured from annual precipitation data spanning the years 1981-2010. *Data taken from -* (<https://datagateway.nrcs.usda.gov/GDGHome.aspx>). The parcel occupies a mid-slope setting with mountainous slopes descending from the south. Cultivation operations on the Project Site consist of mixed light cultivation in hoop houses. All cultivation is conducted in above ground raised beds laid atop established native material / rocked flats (logging landings).

In total 19,000-gallons of water storage exist on-site in the form of rigid plastic storage tanks (two (2) 5,000-gallon tank and four (4) 1,500-gallon tanks and one (1) 3,000-gallon tank. Currently, water is sourced from one location, a permitted groundwater well (see attached well log, permit no. 11/12-0971). Waters from the well is drafted for irrigation, domestic purposes and fire suppression.

---

## TIER AND RISK DESIGNATION

The Cannabis Policy provides criteria for evaluating threats to water quality for cannabis cultivation sites based on three site characteristics: proximity to water body, total disturbed area, and slope of the disturbed area. Based on the criteria and site characteristics the subject property is designated as a **Tier 2 Discharger**. The total disturbed area is 1.53 acres (Table 1). The primary sum of disturbed area on the parcel is represented by cultivation areas followed by roads requiring upgrading, appurtenant buildings, cannabis waste and materials storage and water storage structures. Cultivation takes place on several large historic flats occupying ridge nose settings. These flats are connected by a legacy logging



road network which runs throughout the Project Site. The previous landowner and current cultivator have taken advantage of the cleared areas for the cultivation of cannabis and have not developed additional flats on the property.

A risk designation is assigned based on the slope of the disturbed areas and proximity to a waterbody. Based on these parameters, the subject property is designated as a **Low Risk** site. A total disturbed area of 1.53 acres exists on the Project Site, all of which is located on slopes less than 30%. The parcel is steep and mountainous in general, however the historically developed flats are all well sited on descending ridge noses. These sites were likely selected for as developable areas due to the natural stability of ridge noses for landing creation. All outdoor cultivation areas consisting of 34,998 sq. ft of raised beds in greenhouses are located outside of any riparian buffer zones of surface waters within the Project Site (Table 1).

Table 1: Disturbed Area Size, Slopes, and Setbacks

Disturbed Area Type	Area (ft <sup>2</sup> )	Disturbed Area Slope	Distance to Water Body (ft.)	Water Body Type
Cultivation Areas	34,998	22%	>200	CII
Immature Plant Areas	200	13%	>150	CIII
Road / portions needing upgrades / reconditioning	28,000	15%	-	-
Water Storage Tanks	253	14%	140	Class III
Structures (storage)	832	11%	>150	Class III
Compost Location	400	15%	175	Class III
Cannabis waste Storage	400	15%	175	Class III
Soil Pile	400	13%	170	CIII
Cannabis wastes	1000	22%	150	CIII
<b>Total Disturbed Area</b>	<b>66,483</b>	16% (avg)	-	-

The main road used to access the parcel is a private road accessible from Old 3-Creeks road off California Highway 299. All cultivation takes place on historically developed flats. Approximately 3.09 miles of private access road were assessed by NorthPoint staff on the Project Site. For purposes of this document, the private access road has been categorized as “Main Access Road” and “Secondary Access Road” respectively. Additional roads include Cultivation Area #3 Access Road, Cultivation Area #4 Access Road and “Not In-Use Road”. The roads were previously developed as part of logging activities on the parcel and are generally maintained in good shape.

Disturbance areas calculated as part of the impacts on the Project Site have been taken to include cultivation sites, road portions which require remediation to prevent erosion, water storage structures, accessory buildings and soil and or waste piles. The road sections on the Project Site are generally in stable condition and featured multiple permanent drainage features (rolling dips) however many were showing signs of advanced age and need to be reconditioned to adequately outlet surface runoff from the road network. Additional stretches of road were identified as part of the property wide field investigation which lacked permanent drainage features and have been recommended for upgrade. The roads



are constructed with native material for the driving surfaces, much of which is rock. Several possible sediment delivery sites were observed on the parcel, all of which were related to the road network in conjunction with proximity to stream crossings. Road upgrades including re-establishment of existing rolling dips, the installation of proposed rolling dips and the maintenance of existing ditches have been prescribed as part of this Site Management Plan (SMP) to prevent continued erosion along the road surface. In general, roads on the Project Site are maintained according to the guidance provided by the *Handbook for Forest, Ranch, and Rural Roads* (Weaver, Weppner & Hagans, 2015) (“Roads Handbook”). Thus, as described in section 1.1.2 below, only those portions of the road not meeting the design criteria for road performance have been included in the total disturbed area. A total disturbed area of 66,483 sf (1.53 acres) has been identified as part of this SMP. See the disturbance area callouts in Appendix A for areas included in the total calculation for disturbed area. See Table 1., above for disturbance area totals by category.

---

## **BEST PRACTICAL TREATMENT OR CONTROL (BPTC) MEASURES**

BPTC measures are being utilized as part of the road maintenance program to protect water quality. The *Solid Waste Management, Construction Site Best Management Practices Manual* by the CA Department of Transportation (Caltrans) is referenced for the correct installation, maintenance, and monitoring of all applicable erosion control and sediment capture BPTC measures.

All straw mulch must be free of noxious weeds and all seed/plants must be non-invasive. A list of prohibited species can be found in the CA Invasive Plant Council’s database. Erosion control measures shall not include synthetic monofilament netting, including photo- and biodegradable plastic netting. All netting shall be made of jute, coir fiber, hemp, or another product without welded weaves.

A schedule of BPTC measures to be implemented and maintained throughout the site is shown in Appendix C, and Appendix D includes specifications for BPTCs.

---

### **1. SEDIMENT DISCHARGE BPTC MEASURES**

#### **1.1. SITE CHARACTERISTICS**

##### **1.1.1. SITE MAP**

The site map shows all relevant site features: streams, stream crossings, storage areas, roads, buildings, cultivation areas, and other disturbed areas related to cultivation activities. Erosion prevention and sediment control BPTC measures are identified on the site map (see Appendix A).

##### **1.1.2. ROAD CONDITIONS**

The Project Site is accessed via privately maintained roads off CA Highway 299 (Old 3 Creeks Road thence private access road). The road network on the parcel was previously developed as part of legacy timber harvesting activities. The road network consists of native material roads primarily composed of rock surfacing.



The rocky geology of the region is apparent in nearly all cut and fill faces as well as the road running surface. A single access road provides ingress and egress to the site from the main access road (Old 3 Creeks Road). The shared use access road is in good condition without significant runs of gulying or rilling. The party responsible for the creation of the road network demonstrated some knowledge of hydrology and rural road creation as evidenced by the worn permanent drainage features. See section 1.2.1.1., below for road upgrade descriptions.

Old 3 Creeks Road receives an unknown number of daily vehicle trips at any point in the year. The private "Main Access Road" continues through the parcel to provide access to neighboring parcels. During NorthPoint's field investigation of the Project Site, no traffic was observed on any of the access roads at any point during the approximately 3 - hour site inspection. Additional road maintenance is prescribed in section 1.2.1.1., below.

The roads throughout the Project Site were well constructed with respect to road grades, stream crossing approaches and drainage features. The road network features many rolling dips. Several of the rolling dips require reconditioning to maintain their effectiveness, however it should be noted that their presence appears to be directly responsible for the lack of excessive erosion and wear on the road surface. Additional rolling dips have been prescribed to break up hydrologic flow along the road surface.

At STX-3, both right and left road approaches show signs of wear (rilling and minor gulying). The right and left road should be hydrologically disconnected with the installation of type-1 rolling dips 60-feet and 115-feet from the axis of the crossing respectively.

At STX-6, the right road should be disconnected with a type-1 rolling dip approximately 30-feet from the axis of the crossing.

At STX-9, the left road experiences pervasive seasonal moisture along the road surface due to an emergent cut bank seep feature approximately 1,020-feet up the left road. The gentle grade (approximately 2-5%) leading from the seep toward STX-9 has resulted in only minor wear of the road surface and little to no rilling or gulying. The road surface does appear to be connected from the cutbank seep to the surface water crossing and should be disconnected with the installation of three (3) type-1 rolling dips, the reconditioning of one (1) existing rolling dip and the installation of one (1) rocked dip. The rocked dip will be located at the point where moisture from the cut bank seep encounters the road surface to convey seep flow across and off the running surface of the road.

At STX-11, an existing dip located approximately 30-feet up the left road from the axis of the crossing requires reconditioning to help outlet road surface runoff. Additional rolling dips are proposed to break up hydrologic flow on the road surface.



At STX-15, spring flow which ultimately passes through the culverted crossing seeps across the road and delivers sediment from the road surface to the outlet of the crossing. The spring historically flowed through a ditch relief culvert (DRC) which is currently plugged with the existing ditch having been filled in from sedimentation. The ditch and the inlet to the DRC should be cleaned and maintained to allow flows to resume without overtopping and spilling onto the road running surface. If the DRC is in too poor of condition to function with cleaning alone, it should be replaced.

At STX-16, the left road shows evidence of past delivery due to spring flow spilling out from the inboard ditch and making its way across the running surface of the road. The inboard ditch will be maintained to prevent flows from entering the road surface.

See Appendix A. for the location of the proposed road drainage features.

#### 1.1.3. WATER BODIES, STREAM CROSSINGS, RIPARIAN SETBACKS

The Project Site occupies a mid-slope setting amidst a densely forested canopy typical of advanced primary and secondary growth (post clear-cutting) conditions. The site drains northward and comprises the headwaters of the east stem of Supply Creek as mapped on the USGS “Willow Creek” quadrangle map. Supply Creek is a Class I watercourse.

Sixteen (16) surface water crossings were identified as part of NorthPoint’s field investigation on the Project Site (STX-1-16). STX-1 consisted of a rocked ford crossing on a not in-use road, all other crossings were culverted save for STX-13, which lacks a formal conveyance structure and currently passes flows through STX-12.

Water is sourced from a single groundwater well which meets all required water needs for the parcel including domestic, irrigation and fire suppression purposes.

A previously existing Lake or Streambed Alteration Agreement (LSAA) with the California Department of Fish and Wildlife (CDFW) was executed for the Project Site in 2013 but has since expired (LSAA No. 1600-2013-0156-R1). Currently, an updated LSAA has been submitted to permit and notify for the existing (16) jurisdictional projects on the Project Site.

All proposed cultivation areas, proposed storage facilities and planned stockpiled materials on the Project Site are outside of the riparian buffer zones of any nearby surface waters. The property was acquired by the current landowner as of 2018. During the time of NorthPoint’s field investigation the current landowner was in the process of cleaning the property from the previous occupants. Good housekeeping practices were being put into place on the Project Site at the time of NorthPoint’s field investigation but additional cleaning of domestic and cultivation related wastes is required.

#### 1.1.4. SOIL DISTURBANCE

Soil disturbance on the Project Site is minimal in nature and is constrained to the refurbishment of Cultivation Areas #2 and #3. All cultivation areas occupy previously graded and cleared areas which were developed as part of timber operations on the Project Site. Cultivation Area #2 occupies a previously developed site but appears to have been brushed and scraped as of 2014 as part of property maintenance. A review of the aerial imagery does not indicate significant amounts of cut and fill earthwork occurred. Cultivation Area #3 appears to have had the surface of an existing flat scraped sometime in 2014 resulting in a slightly larger landing area when spoils were pushed off the flat. Again, this earthwork does not appear to be significant as per review of available aerial imagery.

The disturbed areas (landings) appeared stable at the time of the site inspection, no visual indicators of instability (slumping, scarping, cracking, etc.) were noted.

### 1.2. SEDIMENT EROSION PREVENTION AND SEDIMENT CAPTURE

#### 1.2.1. EROSION PREVENTION BPTC MEASURES

##### 1.2.1.1. ROADS

The Project Site features an extensive road network consisting of “Main Access Road” (1.63 miles), “Secondary Access Road” (0.68 miles), “CA #3 Access Road” (0.12 miles), “CA #4 Access Road (0.1 miles) and a road which due to a rock slide event has not been used; “Not in-use Road (0.51 miles). The road network is a legacy feature on the property developed during times of timber operations on the site. The road is well constructed and features numerous permanent drainage features (dips and rolling dips) which serve to break up hydrologic flow on the road surface but could be improved with the installation of additional features. As such, additional drainage features have been prescribed to break up hydrologic flow on the road and prevent erosion and delivery of sediment to surface waters.

To address drainage related issues on **Main Access Road**, the following drainage solutions have been prescribed:

- Install twenty-eight (28) type-1 rolling dips at recommended locations.
- Recondition six (6) existing rolling dips to ensure they are adequately draining sheet flow and disconnecting the road network.
- Install one (1) rocked dip to drain seasonal seepage from the cut bank off the road network.
- Clear the inlet of one (1) plugged ditch relief culvert (DRC) and reinforce the existing inboard ditch.



- See Appendix A (Site Map) for specific locations of recommended drainage features.

To address drainage related issues on **Secondary Access Road**, the following drainage solutions have been prescribed:

- Install five (5) type-1 rolling dips at recommended locations.
- Maintain and recondition when necessary two (2) existing rolling dips to ensure they are adequately draining sheet flow and disconnecting the road network.
- Install one (1) critical dip on the left hinge line at an existing DRC to prevent diversion along the road surface in the event of a culvert failure (plugging).
  - See Appendix A (Site Map) for specific locations of recommended drainage features.

No drainage related issues were identified on the short stretch of access road identified as “**Cultivation Area #3 Access Road**”. As such no drainage features have been prescribed as part of this document.

No drainage related issues were identified on the short stretch of access road identified as “**Cultivation Area #4 Access Road**”. As such no drainage features have been prescribed as part of this document.

No drainage related issues were identified on “**Not In-Use Road**”. A single stream crossing (STX-1) was observed consisting of a well installed rocked ford crossing. Both left and right road approaches to the crossing were rocked and the crossing location did not appear to exhibit signs of erosion or sediment delivery. Disconnected from the main access road due to a rock fall, the road has remained in good condition. The road surface was rocked (native material) with long outsloped sections. No pervasive rilling, gullyng or other indicators of erosion were observed. The road is not used as part of operations on the Project Site and the current landowner and operator has no intention of reopening the road for access. As such no drainage features have been prescribed as part of this document.

Erosion prevention measures including the maintenance of DRCs, the reinforcement of existing IBDs, the installation of the rolling dips, rocked dips, critical dips and the reconditioning of existing dips will be implemented during the dry summer months. The road construction standards described in the “Roads Handbook” will be adhered to for all road improvements. See Appendix C for the Schedule of BPTC Implementation and Maintenance.

#### 1.2.1.2. DISTURBED AREAS

All cultivation activities occur on historically created graded flats. The flats or landings were developed on naturally occurring flat locations

along descending “ridge-noses” where cut and fill earthwork efforts were minimal to create the maximum amount of usable space. All roads and developed or disturbed areas appear stable and settled, with no obvious indicators of failure (scarping, cracking, slumping) visibly apparent on any exposed surfaces. The cultivation area landings / pads are sparsely-vegetated however a review of aerial imagery shows a lack of revegetation since the time of their creation. Grasses and small shrubs have re-established themselves upon the naturally rocky and well-draining soils and appear similar in density and scope to the surrounding undeveloped exposed lands. No issues related to soil erosion of the landing / pad surfaces was identified during the field investigation onsite. As the landings were created for timber harvesting activities and are not actively eroding or threatening water quality, the “disturbed” area of the locations upon which cultivation occurs was taken to be only the footprint of the cultivation activities themselves. The largest portion of disturbed area not covered by a cultivation facility (hoop house, storage building, etc.) lacking vegetation are those road surface portions requiring attention. The mitigation of potential erosion at these locations will consist of disconnecting the road surface by breaking up flow at frequent intervals with the installation of rolling dips or similar drainage features. Specific measures have been recommended in section 1.2.1.1 above. Inboard ditch reinforcement where upgrades to the ground surface denude existing vegetation shall be reseeded with erosion control seed and mulched with straw hay. Any exposed soil within disturbed areas will be seeded and mulched with straw and erosion control seed at a rate of no less than 5,000-lbs / acres straw (~2-inches thick coverage) and 50-lbs / acre seed. All existing live mulch will be maintained as feasible. In addition to erosion control seed being applied, hay mulch will be applied over the seed for protection from physical erosion (wind & precipitation). There are no planned areas for disturbance / development at this time as part of continued operations on the Project Site.

#### 1.2.1.3. STREAMS AND STREAM CROSSINGS

Sixteen (16) surface water road crossings exist on the Project Site (STX-1 – STX-16).

A headwall to diameter ratio (HW/D) of 0.75 (designed to pass ~3/4 capacity of the total pipe diameter at  $Q=100$ ) was selected as a key design parameter to account for passage of woody debris in transport as per “*Designing Watercourse Crossings for Passage of 100-Year Flood Flows, Wood, and Sediment*” (Cafferata et al, 2017). The amount of wood available for transport on the Project Site, the characteristics of the bedload combined with the drainage abilities of the soils minimize the likelihood of culvert failure due to plugging or racking of woody debris and justifies the design selection of a HW/D ratio of 0.75.

STX-1: Located at: 40.980776°, -123.733313°, STX-1 consists of an intermittent CIII watercourse with channel dimensions 4-feet wide by 1-foot in depth which crosses a currently not in-use access road via a rocked ford crossing. The crossing appears to have been recently installed. Vehicular access to the road is prevented due to a portion of the road which has slid away due to a rockslide approximately 750-feet up the right road approach. The rocked and native material road is dipped and rocked through the approaches to the crossing site. A well-constructed rocked ford crossing passes flow from the watercourse across the not in-use access road. The crossing is constructed with angular 2' to 4' diameter rip rap rock installed in an apron like fashion below the outboard edge of the crossing. The largest of the rock appears to be placed along the middle and lowest portions of the apron. The rock appears to be keyed in to resist tractive and shear overtopping forces from storm flows. The crossing appears to be functioning adequately and does not appear to be producing erosion. The road did not exhibit signs of erosion or wear where sediment was being delivered to any surface waters. The current landowner has no plans to open the road for access.

Suggested Action: The crossing will be left intact as an armored ford crossing on a not in-use road.

STX-2 Located at: 40.981225°, -123.729559°, STX-2 consists of an at origin spring fed CIII watercourse which crosses an access road. Spring flow emerges from a cut bank spring just upslope of the crossing, as well as an emergent seep located 60-feet up the right road approach in a rocked inboard ditch. Channel dimensions entering the culvert are 3-feet wide by 0.5-feet in depth. There is no apparent channelization upslope of the crossing location and little to no evidence of transport of any woody debris. The outlet of the crossing consists of a half-round downspout which conveys flows across the fill slope and deposits flow at grade. Downstream of the crossing, a shallow ponded area is present where flows spread out over a wide area. The inlet of the existing 18-inch diameter metal culvert is slightly crushed but appeared to be functioning adequately. Diversion potential exists to the left of the crossing.

Suggested Action: While little channel influence is present upstream of the conveyance structure, the culvert pipe appears to be undersized. Culvert sizing calculations indicate that a 13-inch diameter culvert pipe is sufficient in size to handle the expected 100-year streamflow event and associated debris. Field observations of flow rates and channel width indicate that a 24-inch diameter culvert is appropriate to pass flows from the emergent seep / spring water. The crossing will be upgraded with the installation of a 24-inch diameter culvert with a downspout. A critical dip will be installed along the left hinge-line of the axis of the crossing.

STX-3: Located at: 40.980163°, -123.727764°, STX-3 consists of an intermittent CII watercourse with channel dimensions 5.5-feet in width

by 1-foot in depth which crosses an access road through a 42-inch diameter culvert. The culvert appears to have been recently installed, in good shape and appears to be functioning adequately. The crossing outlets at grade onto rock armor to dissipate the erosive energy of the watercourse. Drainage area calculations indicate that a 41-inch diameter culvert is needed to pass the expected 100-year flows and associated debris. There is no diversion potential at this crossing location. The left and right road are hydrologically connected to this crossing site and will be disconnected with the installation of type 1 rolling dips located approximately 180-feet and 70-feet up the left road and right road respectively.

Suggested Action: Install type-1 rolling dips approximately 180-feet and 70-feet up the left road and right road respectively.

STX-4: Located at: 40.979535°, -123.725819°, STX-4 consists of a 48-inch diameter culvert with channel dimensions of 4-feet in width by 1.5-feet in depth which conveys a CIII watercourse through an access road. The current culvert structure appears to have been recently installed, is in good shape and functioning adequately. There is no diversion potential at this location, a functioning critical dip is installed along the left hinge line of the crossing and features rock armor along the outboard edge of the fill slope. The crossing is set high in the fill and outlets onto rock armor on the outboard edge of fill.

Suggested Action: Drainage area calculations indicate that a 56-inch diameter culvert is required to pass the expected 100-year stream flow event and associated debris. However, visual inspection of the crossing site and upstream channel (active channel width, bedload and woody debris available for transport) indicates that a 48-inch diameter culvert will be sufficient in size to pass the expected storm flows and associated debris. The crossing will be left intact with the existing 48-inch diameter culvert. The existing critical dip in the road fill eliminates diversion potential and precludes the need for a new critical dip. The crossing should be monitored for signs of failure and inspected and maintained regularly to ensure that no plugging occurs.

STX-5: Located at: 40.979754°, -123.723747°, STX-5 consist of a 30-inch diameter culvert with channel dimensions 3-feet in width by 1.5-foot in depth which conveys a CIII watercourse through an access road. The Culvert is installed short in the fill and makes use of a half-round downspout to deposit flows from the watercourse beyond the influence of the fill prism. The inlet is open and clear of obstructions. No diversion potential is present at this crossing location.

Suggested Action: Drainage area calculations indicate that a 52-inch diameter culvert is required to pass the expected 100-year stream flow event and associated debris. The crossing will be upgraded with the installation of a 52-inch diameter culvert, placed at natural grade of the stream channel, in the correct orientation of the watercourse flow

path and at the base of fill. The crossing should be monitored for signs of failure and inspected and maintained regularly to ensure that no plugging occurs.

STX-6: Location: 40.981804°, -123.723212°, STX-6 consists of an intermittent CII watercourse with channel dimensions 4-feet in width by 1-foot in depth crossing an access road via a 30-inch diameter culvert. This crossing exhibits diversion potential to the left. A small tree is growing from the inlet, possibly functioning as a trash rack. The crossing is short in the fill and utilizes a half-round downspout to convey flows off of the fill slope of the crossing. Moderate plug potential exists at this crossing site. Large fallen logs upstream and downstream conveyance structure have created complex channel morphology.

Suggested Action: Drainage area calculations indicate that a 66-inch diameter culvert is required to pass the expected 100-year stream flow event and associated debris. Visual inspection of the crossing site and upstream channel (active channel width, bedload and woody debris available for transport) suggest that a 48-inch diameter culvert will be sufficient in size to pass the expected storm flows and associated debris. The crossing will be upgraded with the installation of a 48-inch diameter culvert, placed at natural grade of the stream channel, in the correct orientation of the watercourse flow path and at the base of fill. The crossing should be monitored for signs of failure and inspected and maintained regularly to ensure that no plugging occurs. A critical dip shall be installed along the left hinge line of the crossing to prevent diversion in the event of a culvert failure event. A single post trash rack shall be installed 1 culvert diameter (48-inches) upstream of the proposed inlet to prevent woody debris from racking at the inlet.

STX-7: Location: 40.984827°, -123.721316°, STX-7 consists of an 18-inch diameter culvert inlet which passes flows from an ephemeral CIII watercourse and a CII spring through an access road. Channel dimensions entering the culvert inlet measured approximately 3-feet in width by 0.5-feet in depth. The channelized portion of the watercourse did not appear to pass heavy flows on a regular basis based on visual inspection of scour / wear / erosion patterns as are typical of drainages. The CII spring is present above the inlet of the crossing site and maintains flows enough for the proliferation of algae along the inboard edge of the road embankment outside of the fill prism of the road network. The CIII channel above the inlet was dry and appear to only flow in response to rainfall events. It lacked the strong channel definition of other adjacent channels indicating that a drainage disconnect may have occurred somewhere upstream. The culvert appeared to be sufficient to pass flows from the CII seep. Diversion potential is present to the right of the crossing site.

Suggested Action: Drainage area calculations indicate that a 49-inch diameter culvert is required to pass the expected 100-year stream flow

event and associated debris. Visual inspection of the crossing site indicates that a 48-inch diameter culvert will be sufficient in size to pass the expected storm flows. The crossing will be upgraded with the installation of a 48-inch diameter culvert, placed at natural grade of the stream channel, in the correct orientation of the watercourse flow path and at the base of fill. The crossing should be monitored for signs of failure and inspected and maintained regularly to ensure that no plugging occurs. A critical dip shall be installed along the right hinge line of the crossing to prevent diversion in the event of a culvert failure event.

STX-8: Location: 40.983956°, -123.721397°, STX-8 consists of an 18-inch diameter culvert which passes an ephemeral CIII watercourse with channel dimensions 1-foot in width by 0.5-feet in depth through an access road. The crossing appears to be functioning adequately. The near origin drainage does not exhibit any signs of woody debris in transport, and the bedload features quite small gravels with some cobbles. There is minor diversion potential to the left, the road features an almost functioning “critical” dip, however the dip lacks the revers grade necessary to prevent diversion down the left road in the event of a culvert failure.

Suggested Action: Drainage area calculations indicate that a 25-inch diameter culvert is required to pass the expected 100-year stream flow event and associated debris. Visual inspection of the crossing site indicates that a 24-inch diameter culvert will be sufficient in size to pass the expected storm flows. The crossing will be upgraded with the installation of a 24-inch diameter culvert, placed at natural grade of the stream channel, in the correct orientation of the watercourse flow path and at the base of fill. The crossing should be monitored for signs of failure and inspected and maintained regularly to ensure that no plugging occurs. The existing critical dip shall be reconditioned to functional status to prevent diversion in the event of a culvert failure event.

STX-9: Location: 40.982078°, -123.722585°, STX-9 consists of an intermittent CIII watercourse with channel dimensions 4-feet in width by 1-foot in depth which crosses an access road via a 32-inch diameter culvert. The culvert pipe is slightly perched and passes flows under the road into a small pool. An emergent cut bank seep approximately 1,000 feet up the left road is hydrologically connected to surface waters at STX-9 due to a lack of permanent drainage features on the road surface. The crossing does not exhibit diversion potential.

Suggested Action: Drainage area calculations indicate that at least a 65-inch diameter culvert is required to pass the expected 100-year stream flow event and associated debris. However, visual inspection of the crossing site and upstream channel (active channel width, bedload and woody debris available for transport) indicates that a 48-inch diameter culvert will be sufficient in size to pass the expected



storm flows and associated debris. The crossing will be upgraded with the installation of a 48-inch diameter culvert, placed at natural grade of the stream channel, in the correct orientation of the watercourse flow path and at the base of fill. The crossing should be monitored for signs of failure and inspected and maintained regularly to ensure that no plugging occurs. The road bench may require the import of fill material to raise the profile to allow for the installation of a 48-inch diameter pipe. The left road will be hydrologically disconnected from the crossing with the installation of several type-1 rolling dips at specified intervals including one approximately 60-feet from the axis of the crossing.

STX-10: Location: 40.978973°, -123.723130°, STX-10 consists of an ephemeral CIII with channel dimensions 3-feet in width by 1-foot in depth which crosses an access road through an existing 30-inch diameter culvert placed short in the fill with a half round downspout. Diversion potential exists to the right of the crossing. The crossing appears to be in good condition with the conveyance structure functioning adequately.

Suggested Action: Drainage area calculations indicate that a 49-inch diameter culvert is required to pass the expected 100-year stream flow event and associated debris. Visual inspection of the crossing site and upstream channel (bedload and woody debris available for transport) indicates that a 48-inch diameter culvert will be sufficient in size to pass the expected storm flows. The crossing will be upgraded with the installation of a 48-inch diameter culvert, placed at natural grade of the stream channel, in the correct orientation of the watercourse flow path and at the base of fill. The crossing should be monitored for signs of failure and inspected and maintained regularly to ensure that no plugging occurs. A critical dip will be installed along the right hinge line of the crossing to prevent diversion in the event of a culvert failure.

STX-11: Location: 40.978655°, -123.726286°, STX-11 features an existing 32-inch diameter culvert placed short in the fill with a half round downspout on an intermittent CIII watercourse with channel dimensions 5-feet in width by 1.5-feet in depth. Diversion potential is not present at this crossing location. The crossing appears to be in moderate condition with the conveyance structure functioning adequately. The inlet of the culvert is slightly crushed and the outlet of the downspout is approximately 4 feet above grade and outlets flows onto rock armor.

Suggested Action: Drainage area calculations indicate that at least a 54-inch diameter culvert is required to pass the expected 100-year stream flow event and associated debris. The crossing will be upgraded with the installation of a 54-inch diameter culvert, placed at natural grade of the stream channel, in the correct orientation of the watercourse flow path and at the base of fill. Rock armor sized to resist shear and tractive overtopping flows will be placed at the outlet to

prevent erosion where past scour has occurred. The crossing should be monitored for signs of failure and inspected and maintained regularly to ensure that no plugging occurs.

STX-12: Location: 40.979045°, -123.729186°, STX-12 features an existing 18-inch diameter culvert placed short in the fill which outlets flows through a half round downspout. Diversion potential exists to the right of the crossing location. The crossing is in moderate condition. The inlet of the culvert is slightly crushed. The crossing receives ephemeral flows from an adjacent drainage feature which lacks a formal conveyance structure (STX-13) and is routed along an inboard ditch to STX-12. The main channel upstream of the inlet of STX-12 is steep, mossy and worn bedrock and measures. Combined flows from both drainages enter the inlet at STX-12 in a channel of approximate dimensions 3-feet in width by 0.5-feet in depth. The channel of the drainage feature at STX-13 is poorly defined and is approximately 2-feet wide by 1-foot in depth and appears to be daylighted groundwater as part of an upslope rockslide feature. The watercourse encounters the road network and diverts along the right road within a rocked inboard ditch for approximately 80-feet before flowing through the road at STX-12. The outlet of the downspout of STX-12 delivers flows to a rock filled channel below. Water was observed pooling in several sections below the downspout above the “outlet” of the downspout indicating that subsurface flow is present and that the culvert may be broken or leaking.

Suggested Action: Drainage area calculations incorporating both the watersheds of STX-12 and STX-13 (currently passed through the access road at STX-12) indicate that at a 36-inch diameter culvert is required to pass the expected 100-year stream flow event and associated debris. The crossing will be upgraded with the installation of a 36-inch diameter culvert, placed at natural grade of the stream channel, in the correct orientation of the watercourse flow path and at the base of fill. The crossing should be monitored for signs of failure and inspected and maintained regularly to ensure that no plugging occurs. The rocky inboard ditch / channel of the ephemeral CIII watercourse which passes through STX-13 will be maintained to facilitate flow through STX-12. A critical dip will be installed along the right hinge line of the crossing at STX-12 to prevent diversion in the event of a culvert failure.

STX-13: Location: 40.979181°, -123.729282°, STX-13 consists of an ephemeral CIII drainage with channel dimensions 2-feet in width by 1-foot in depth which seeps from a rockslide feature above the access road. Flow from the drainage diverts down the right road for approximately 80-feet before passing through the road network at an existing 18-inch diameter culvert at STX-12. No channel definition is present below the road bench. Little to no channel definition is present above the road bench, water emerges from a rockslide feature before continuing along

the rocked inboard ditch. Flow then confluences with the drainage that passes through the road network at STX-12.

Suggested Action: To prevent the generation of sediment due to erosion of the hillslope and establishment of a new channel, flows encountering the road at STX-13 will be allowed to continue in their current path along the rocked inboard ditch and passed through STX-12. STX-12 will be sized adequately for the 100-year storm event, as calculated to include both watershed sub drainage basins of STX-12 and STX-13. (See STX-12, above).

STX-14: Location: 40.978198°, -123.733327°, STX-14 passes flow from several winding ephemeral drainages which confluence just upslope of the conveyance structure, a 24-inch diameter steel culvert. One of the drainages encounters the road bench and travels along the inboard ditch of the road for a short distance before entering the culvert. The culvert is embedded within a legacy redwood trash rack (box frame) which has aggraded small woody debris and leaf litter. Flows enter the culvert through a combined channel of approximate dimensions 2.5-feet wide by 0.5-feet in depth. Flow exits the culvert structure and travels off the road fill prism via a half-round downspout. There is no diversion potential associated with this crossing site.

Suggested Action: Drainage area calculations indicate that at a 32-inch diameter culvert is required to pass the expected 100-year stream flow event and associated debris. The crossing will be upgraded with the removal of the redwood box trash rack and the replacement of the existing culvert. The installation of a 32-inch diameter culvert, placed at natural grade of the stream channel, in the correct orientation of the watercourse flow path and at the base of fill. The crossing should be monitored for signs of failure and inspected and maintained regularly to ensure that no plugging occurs. The rocky inboard ditch / channel of the ephemeral CIII watercourse which passes through STX-14 will be maintained and enhanced with a rocked berm to prevent possible overtopping and diversion of the watercourse onto the road network. A single post trash rack should be installed 1-culvert diameter length upstream of the inlet of the new culvert (32-inches).

STX-15: Location: 40.978499°, -123.735460°, STX-15 passes flow from a spring and an ephemeral drainage above the inlet via a drainage with channel dimensions 3-feet in width by 0.5-feet in depth. Flow from the spring fed channel travels parallel with the road before passing through the culvert. STX-15 consist of an 18-inch diameter culvert with a slightly crushed inlet. The culvert is embedded within a legacy redwood trash rack (box frame) which was open and unobstructed at the time of the site inspection. Flow exits the culvert structure and travels off the road fill prism via a half-round downspout. There is no diversion potential associated with this crossing site.

Suggested Action: Drainage area calculations indicate that at a 24-inch diameter culvert is required to pass the expected 100-year stream flow event and associated debris. The crossing will be upgraded with the removal of the redwood trash rack and the installation of a 24-inch diameter culvert, placed at natural grade of the stream channel, in the correct orientation of the watercourse flow path and at the base of fill. The crossing should be monitored for signs of failure and inspected and maintained regularly to ensure that no plugging occurs. A single post trash rack will be installed 1 culvert diameter length upstream of the inlet (24-inches) to prevent woody debris from racking against the inlet.

STX-16: Location: 40.979017°, -123.735905°, STX-16 passes flow from a nearby spring. Upslope of the crossing site, the crossing may pass overland flow but lacks discernable channel definition. Most of the flows passing through the culvert appear to come from the spring. The crossing consists of a 24-inch diameter steel culvert with a torn inlet. The culvert is exposed atop the inboard portion of the road surface and has been torn open by vehicle traffic. The culvert inlet is inset within a legacy redwood trash rack (box frame) which has aggraded minor leaf litter. Flow exits the culvert structure and travels off the road fill prism via a half-round downspout. An approximate 4-foot drop was noted at the outlet of the downspout. There did not appear to be active erosion as a result of the drop in the outlet at the time of the site inspection. There is diversion potential to the right associated with this crossing site.

Suggested Action: Drainage area calculations indicate that existing pipe is sufficiently sized to pass the expected 100-year stream flow event and associated debris. The crossing appears to be functioning adequately, however the culvert structure itself is worn at the inlet and where exposed and torn on the road surface. The crossing will be upgraded with removal of the box frame trash rack and the replacement of the existing structure (24-inch diameter culvert). The new culvert will be placed at natural grade of the stream channel, in the correct orientation of the watercourse flow path and at the base of fill. The road bench may need to be raised to allow for the correct amount of fill material to protect the conveyance structure. Rock armor should be placed in the area where the previous scour occurred due to the outlet structures past placement above the natural channel grade. A critical dip will be installed along the right hinge line of the crossing to prevent diversion in the event of a culvert failure. A single post trash rack will be installed one culvert diameter length (24-inches) upstream of the proposed inlet.

All culverts on the property shall be inspected for plugging potential (racking of sticks, small woody debris and aggradation of sediments) regularly and before the onset of the winter period each year. Any debris noted at the inlets of any culverts shall be removed and the openings

cleared to maintain the hydraulic capacity of the culvert. Any removed sediment or debris will be stored outside of the riparian buffer zone where no threat of delivery to surface waters is present.

#### 1.2.1.4. WINTERIZATION

Winterization measures will be implemented annually by November 1st and interim erosion prevention BPTC measures will be utilized as needed throughout the year. To prevent erosion and sediment transport to streams, numerous measures for soil stabilization, runoff management, erosion and sediment prevention/retention are utilized throughout the seasonally dry period and prior to the onset of winter. Section 5 “Winterization BPTC Measures” has more information on proposed actions to protect water quality in the winter season.

#### 1.2.2. SEDIMENT CAPTURE BPTC MEASURES

##### 1.2.2.1. ROADS, STREAM CROSSINGS, AND SOIL DISTURBANCE

Cultivation operations on the Project Site occur in an area sufficiently far from channelized surface waters to prevent delivery of sediment. Cultivation occurs in above ground raised beds within hoop houses. Soil is amended annually and reused each season. In the event soil is to be “piled” to be reamended, proper BPTCs will be utilized to winterize the site. Any soil piles on the Project Site will be properly winterized by encircling the pile with straw wattles and utilizing cover crops or tarps to prevent precipitation and runoff from mobilizing sediment and the constituent components of the potting soils. If winter conditions preclude the use of cover cropping throughout the wet weather season, tarps or a constructed roof covering will be utilized to prevent piles from washing away and remaining nutrients from leaching into groundwater. Straw wattles will be utilized around soil piles to further mitigate sediment transport during wet weather events. Raised beds containing potting soils and other growing media will be cover cropped.

See 1.2.1.1 for road related BPTCs and prescribed treatments.

The areas utilized for cultivation on the Project site are relatively well-vegetated with grasses to protect against erosion. The areas appeared to be stable and did not appear to be actively eroding.

Areas disturbed as part of the upgrade process on the Project site must be revegetated with erosion control seed and mulched to protect against erosion. BPTCs should include the use of slope protecting Rolled Erosion Control Products (RECP), hydroseed, and staked straw wattles on the toe of fill at the break in slope to prevent sheet flow from carrying entrained particulate from the bare soil pad and fill slopes. Due to the steepness of fill slopes to be disturbed during necessary stream crossing upgrades, linear sediment controls will be required. As per Attachment A (pg. 47,

no. 128) cannabis cultivators shall apply linear sediment controls along the toe of the slope, face of the slope and at the grade breaks of exposed slopes to comply with sheet flow length restrictions. For slopes (percent slope) between 25-50%, sheet flow length shall not exceed 15-feet. For slopes greater than 50% in slope, sheet flow length shall not exceed 10-feet. Thus, at each break in slope, toe of slope, or unbroken length of disturbed slope measuring 10-15-feet in length (depending on grade) a linear sediment control must be utilized until vegetation is re-established such that sheet flow does not result in erosion or scour of bare soil. Soil disturbance on steep fill slopes is expected during the upgrade process of stream crossings on the Project Site.

Stockpiled materials for construction and road maintenance will be stored in stable locations and contained using appropriate BPTC measures including straw wattles, silt fences and tarping or cover cropping. Other sediment control measures may be installed as needed to prevent discharges from entering waters of the state. See Appendix C for the schedule of all sediment control BPTC measures being employed on site.

### 1.2.3. MAINTENANCE ACTIVITIES – EROSION PREVENTION AND SEDIMENT CAPTURE

#### 1.2.3.1. MONITORING

All long-term and interim erosion prevention and sediment capture BPTC measures that have been implemented will be monitored for effectiveness once monthly at a minimum (Table 1.2.3.1). Any vegetation planted on previously disturbed areas will be monitored for success and replanted as necessary. The cultivator will monitor erosion and sediment control measures during and after each storm event that produces at least 0.5 in/day or 1 in/7 days of precipitation. In addition, winterization measures that are implemented will be monitored for effectiveness (inspected during the first major winter storm event) before the site is closed for the winter. See Appendix H for a log of monthly BPTC monitoring and maintenance records.

Table 1.2.3.1. BPTC Effectiveness Monitoring

Monitoring Requirements	Description	Monitoring Frequency
<b>Winterization Measures Implemented</b>	Report winterization procedures implemented, any outstanding measures, and the schedule for completion.	October - May
<b>Tier Status Confirmation</b>	Report any change in the tier status. (Stabilization of disturbed areas may change the tier status of a facility. Contact the Regional Water Board if a change in status is appropriate).	Annually
<b>Third Party Identification</b>	Report any change in third party status as needed	Annually

#### 1.2.3.2. MAINTENANCE

Year-round maintenance of all erosion prevention and sediment capture measures is required. All existing measures shall be maintained, repaired, or replaced as needed. Exotic or invasive species found in revegetated or disturbed areas shall be removed. Remaining exposed soil shall be reseeded/revegetated and have 2-4" of weed-free mulch reapplied. Any captured sediment in inboard ditches/drainageways, culvert outfalls, sediment capture basins or against silt fences/straw wattles will be removed and stabilized on an area outside of any riparian zones where it will not deliver to surface waters. The sediment may be used for site improvement where it will not threaten water quality. Interim measures for sediment retention, such as mulching and wattling, require more regular monitoring and maintenance. See Appendix H for a log of monthly BPTC monitoring and maintenance records.

## 2. FERTILIZER, PESTICIDE, HERBICIDE, AND RODENTICIDE BPTC MEASURES

### 2.1. CULTIVATION PRODUCT STORAGE, USE, AND DISPOSAL

#### 2.1.1. STORAGE

Agricultural chemicals are stored within a designated covered space adjacent to Cultivation Area #1. Agricultural chemicals including fertilizer and any other pesticides / herbicides / rodenticides that are deemed necessary are stored outside of all riparian buffers and are routinely kept in a singular location while on the property. During times of non-operation in the wintertime, nutrients and agricultural chemicals are removed from the Project Site until operations resume in the springtime.

The storage building is secured from wildlife, and all agricultural chemicals shall be stored within secondary containment to prevent unintended release in the event of a containment failure. The containment vessels shall be sufficient in size to contain 110% of the volume contained within each vessel. The freeboard of the containment vessel should not be filled due to being stored under cover and out of the elements (see Site Map in Appendix A for storage location). Soil and fertilizers may temporarily be stored in or near the greenhouses within 48 hours prior to being applied but should be removed immediately post use to a secure location where they pose no threat of delivery to surface waters or leachate to groundwater.

Appropriate BPTC measures shall be utilized when storing, handling, mixing, applying, and disposing of all fertilizers, pesticides, herbicides, and rodenticides. Each year an inventory is conducted prior to the beginning of the grow season and necessary products are delivered to the site as needed. See Appendix G for a list of fertilizers and pesticides/herbicides used on site.

#### 2.1.2. APPLICATION

Mixing of fertilizers occurs in 500-gallon and 2,500-gallon storage tanks and shall be conducted in a designated area where the mix shall not enter surface waters. For all plants, the mix will be applied via controlled hand watering. A fertigation system may be implemented in the future but is not required for accurate application of nutrients / fertilizers. Spent soil shall be amended and reused as needed. Dry amendments are to be mixed into the raised beds or soil piles by hand at the rate specified by the manufacturers. The application of any agricultural chemical products shall be conducted according the manufacturer's recommendation.

#### 2.1.3. DISPOSAL AND SPILL PREVENTION/CLEANUP

Trash and recycling containers are currently located adjacent to the storage building at Cultivation Area #1. The current operators of the site were engaged in a property wide cleanup endeavor at the time of NorthPoint's field investigation however additional cleanup of the site is required. Various household and cultivation related wastes were observed strewn about the Cultivation Area which appeared to have been the result of several years of onsite dumping of garbage. The current operator of the site indicated that multiple trailer loads of wastes and trash had already been removed and that efforts were continuing to remove junk from the property. Soil is reamended annually and is typically amended in place (raised beds). Soil may be temporarily piled outside of raised beds for reamendment and mixing with dry amendments when required or dictated by soil analysis. A spill kit with plenty of sorbent pads will be kept on site in the event of a spill for any agricultural chemical or hazardous waste that is anticipated for use on site. All trash, empty



product containers, and other recycling shall be hauled off-site on regular or weekly intervals to the nearest Waste Management Facility.

### 3. PETROLEUM PRODUCT BPTC MEASURES

#### 3.1. PETROLEUM STORAGE, USE, AND DISPOSAL

Table 3.1. Petroleum Product List, Storage, and Use

Petroleum Product	Delivery Period	Storage Method	Use Type
Gasoline / Diesel	As needed throughout the year	5-gallon gas cans	Power for garden tools / equipment
Lubricants	As needed throughout the year	When onsite shall be stored in storage shed within secondary containment	Garden Equipment maintenance
Propane	As needed throughout the year	5 and 25-gallon portable propane tanks	Domestic (heating, cooking, etc.)

##### 3.1.1 STORAGE

There are currently several small fuel storage vessels on the Project Site (5-gallon). The current petroleum storage vessels were placed under cover from the elements but lacked secondary containment. The owner and operators of the Project Site intend to move to solar power for self-sufficiency and sustainability but are currently relying on petroleum powered generators. Storage of petroleum products (when onsite) shall be stored within secondary containment under cover of the storage building outside of any riparian setbacks.

As per the Order, all petroleum containers must be stored within secondary containment and under cover sufficient to prevent precipitation from filling the freeboard of the containment vessel or berm. It is the intention of the operator to both cover and provide secondary containment for all petroleum storage to comply with the Order.

Any petroleum powered machines shall be regularly monitored for leakage. No petroleum powered vehicles or machines apart from employees personal vehicles were stored onsite at the time of NorthPoint's field investigation.

##### 3.1.2. APPLICATION

Fueling and maintenance of water pumps, vehicles, and other machines shall be conducted in a designated area that prohibits discharge to waters of the state.

##### 3.1.3. DISPOSAL AND SPILL PREVENTION/CLEANUP

Special care will be taken when transporting and handling all petroleum products. When and if petroleum products are brought onsite, spill

prevention/cleanup BPTC measures will be utilized; a spill kit with plenty of sorbent pads shall be kept on site in the event of a spill. Spill kits shall be kept in areas where fuel transfers or refueling is expected to occur. When staff are to be onsite, they shall be trained in the use and location of the spill kits to ensure that should a spill occurs, any available hands shall be trained to apply BPTC measures. Spent petroleum products and related trash will be kept in secondary containment, specifically for hazardous waste, before being transferred to the waste management facility. Several waste oil or petroleum products (gas cans) were observed onsite adjacent to the storage building at Cultivation Area #1 during the field investigation.

#### **4. TRASH/REFUSE AND DOMESTIC WASTEWATER BPTC MEASURES**

##### **4.1. HOUSEHOLD TRASH AND CULTIVATION-RELATED WASTE**

At the time of the site inspection various trash was observed from the previous occupants / operators of the Project Site. The current operators were engaged in cleaning up the Project Site, however significant amounts of household and cultivation related wastes remained. All trash / refuse generated on site shall be placed in lidded plastic storage bins as well as plastic bags. Trash kept adjacent to the cultivation area will be done so in a lidded trash can and ultimately stored within a storage shed to prevent wildlife intrusion. In general, trash and recycling should be kept and stored in a storage location that prevents both elemental and wildlife intrusion (storage shed). These enclosed and designated areas designed to prevent contact with wildlife and precipitation will ensure compliance with the Order. Expected trash/refuse generated on site will be comprised of domestic wastes including food and sanitation items as well as cultivation related wastes (empty nutrient containers, associated packaging and consumable items). All trash items shall be kept in a designated area (see site map in Appendix A) where it will not migrate or leach into waters of the state. Cultivation-related organic wastes are stored in a designated area and stabilized with the appropriate BPTC measures (see Appendix A, Site Plan for location). Non-organic cultivation related wastes shall be taken to the nearest waste management facility along with all other disposable wastes generated onsite at regular (weekly) intervals. Wastes shall not be stored onsite for prolonged periods of time.

##### **4.2. RESIDENTS, EMPLOYEES, AND VISITORS**

There are no residences on the Project Site. The farm shall be run with approximately 6 employees in addition to the owner / operator of the site. Employees will commute to the site from nearby residential areas in Willow Creek and the surrounding communities.

##### **4.2.1 DOMESTIC WASTEWATER – GENERATION**

The Project Site produces wastewater from a composting toilet. A septic system may be designed for the Project Site, however while the system is being designed and permitted by a septic professional to ensure it meets the needs of the expected level of uses, portable toilets will be brought onsite and serviced at regular intervals. The portable toilets will ensure that the sanitary needs of the site operators are met while satisfying the



wastewater requirements of local and state agencies. Receipts for the portable toilets will be kept onsite.

#### 4.2.2 DOMESTIC WASTEWATER - DISPOSAL

Household greywater is generated on the Project Site from an outdoor shower adjacent the storage building at Cultivation Area #1. Greywater is disposed of by infiltration into the native surface. Domestic wastewater is not expected to be generated onsite. The cultivator shall make sure that no substances that are hazardous to fish and wildlife (e.g. trash, paint, concrete washings, treated wood) are used, located, or disposed of where they can contaminate waters of the state. Human and animal waste shall also be disposed of properly.

### 5. WINTERIZATION BPTC MEASURES

#### 5.1. ACTIVITIES AND MAINTENANCE

##### 5.1.1 ROADS AND STREAM CROSSINGS

Appropriate erosion prevention and sediment control measures will be installed, maintained, and monitored for effectiveness prior to the winter season. Road work requiring heavy machinery (rolling dip, rocked dips, inboard ditch maintenance, etc.) shall be conducted only during the dry season, unless the cultivator is authorized by an agency with jurisdiction to make emergency repairs. See section 1.2.1.1. for road related upgrades and treatments.

Winterization of the access roads includes temporary and long-term runoff management. Winterization of the site will include the installation of appropriate BPTC measures relevant to the mitigation of sheet flow and erosion on the road surface and outboard fill slopes of stream crossings which may contain bare or exposed soils post upgrades. All winterization BPTC measures will be monitored and maintained prior to site closure for the winter.

##### 5.1.2. DISTURBED AREAS

Areas that have exposed soil shall be seeded and mulched to prevent erosion and sediment delivery to any waterbody. Any revegetation shall take place at the onset or at the end of the precipitation season to ensure establishment. All disturbed areas will be inspected for potential and active erosion issues. Such sites will be repaired/controlled as needed using appropriate BPTC measures. For all areas of concern, if any BPTC measures cannot be installed prior to winter, the Regional Water Board must be contacted to establish a compliance schedule to protect water quality. At the time of Northpoint's field investigation, no "disturbed areas" that threatened to deliver sediment to surface waters were identified outside of the previously listed road sections as per section 1.2.1.1, above.

The flats upon which cultivation occurs are relatively well-vegetated. Proposed road upgrades and BPTC implementation on the Project Site (stream crossing upgrades) are expected to disturb existing vegetation and will be revegetated with erosion control seed and mulched to protect against erosion. BPTCs should include the use of seed and straw mulch or hydroseed and staked straw wattles or silt fences on the toe of fill at the break in slope to prevent sheet flow from carrying entrained particulate from exposed soils as per Attachment A of the Order (pg. 47, no. 128) (See section 1.2.2.1., above).

### 5.1.3. STORAGE AND STOCKPILED MATERIALS

#### 5.1.3.1. CULTIVATION-RELATED PRODUCTS AND WASTE

All fertilizers, pesticides, herbicides, and rodenticides will be stored where they will not enter surface waters or pose a threat to wildlife. The cultivator will have all liquid products stored in secondary containment and stored along with all other cultivation-related products, protected from the elements. Waste associated with cultivation will be removed from the site and taken to the nearest waste transfer facility prior to closing the site for winter.

#### 5.1.3.2. VEHICLES, MACHINES, AND PETROLEUM PRODUCTS / WASTE

Prior to winter, any remaining vehicles or machines on-site will be stored out of the elements where any potential leaks will not enter surface waters or pose a threat to wildlife. All storage facilities will be locked to prevent wildlife intrusion. Petroleum products will be kept in compatible secondary containment within their own storage container. Any spent petroleum containers and related trash will be removed and appropriately disposed of at the nearest waste management facility.

#### 5.1.3.3. STOCKPILED MATERIALS

Appropriate BPTC measures shall be used for all stockpiled materials that have the potential to migrate to surface waters or that may be hazardous to wildlife. Stockpiled materials include bark, sawdust, potting soil, amendments, rock, compost, treated wood, polytube and other irrigation equipment, greenhouse plastic sheeting, and any other materials used for cultivation and site development, improvement, and management. They shall be stabilized in an upland area, covered, and/or stored in a storage shed/container.



# Appendix A: Site Map

# NEW EARTH FARMS, LLC SITE MANAGEMENT PLAN

APN: 522-024-001

**DIRECTIONS TO SITE**  
FROM EUREKA, CA  
-TAKE US-101 N/ 5TH ST.  
-TAKE CA-299  
-CONTINUE ON OLD 3 CREEKS ROAD  
-SPLIT TO RIGHT TOWARD "BUCK BUTTES"



**VICINITY MAP**  
NOT TO SCALE

NEW EARTH FARMS  
APN: 522-024-001  
±318.89 ACRES

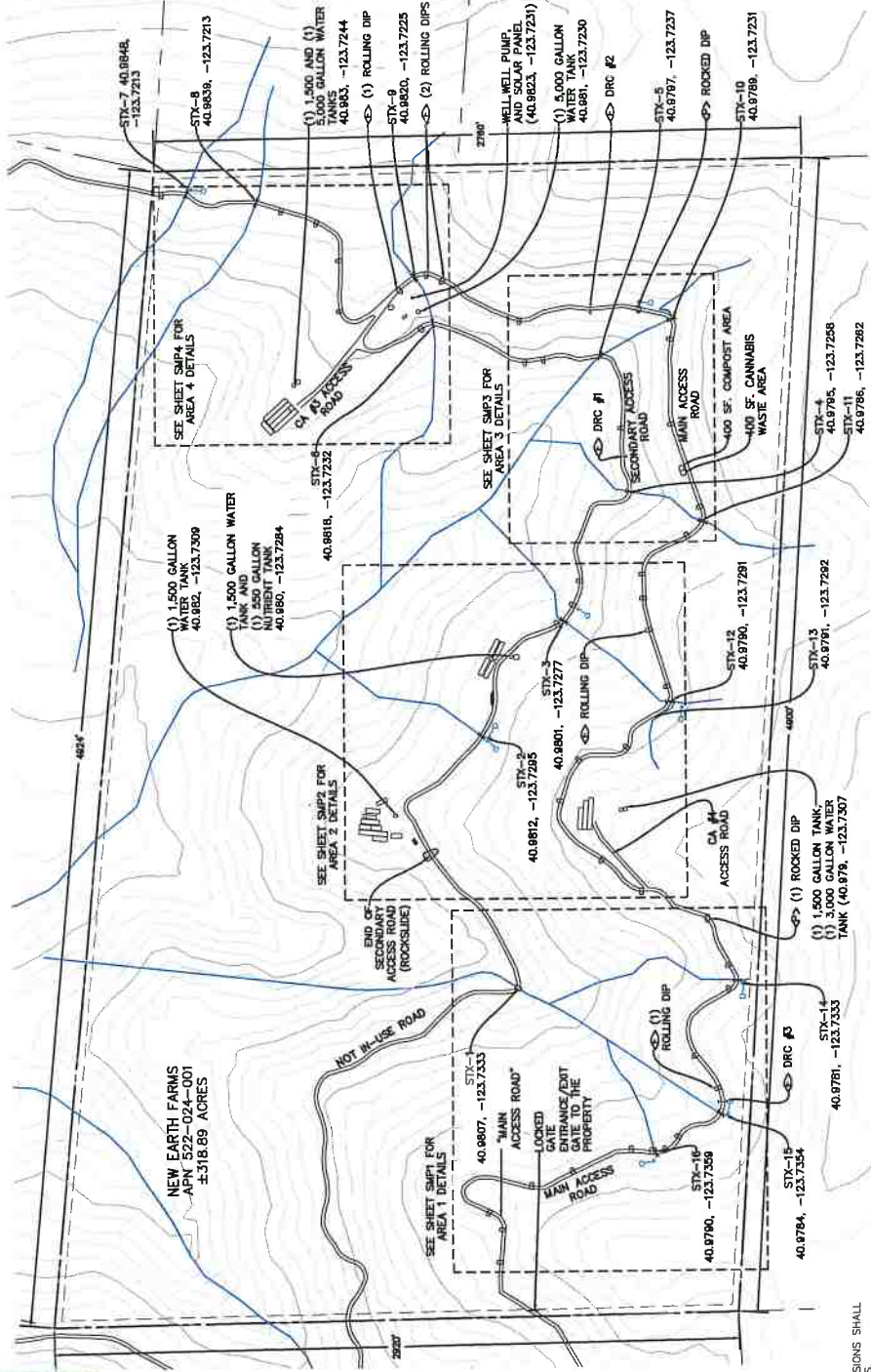

**NORTHPOINT**  
CONSULTING GROUP, INC.  
317 3rd Street, Ste 15 Eureka, CA 95501

NEW EARTH FARMS, LLC / APN:522-024-001  
OLD 3 CREEKS ROAD WILLOW CREEK, CA 95573  
SMP PLOT PLAN, VICINITY MAP, AND PROJECT NOTES

**SMPO**  
18-123

**SHEET INDEX**  
SMPO - PLOT PLAN, VICINITY MAP, AND PROJECT NOTES  
SMP1 - AREA 1 MAP  
SMP2 - AREA 2 MAP  
SMP3 - AREA 3 MAP  
SMP4 - AREA 4 MAP



**PLOT PLAN**  
22x34 SHEET: 1"=250'  
11x17 SHEET: 1"=500'

**LEGEND:**  
○ = SPRING

**GENERAL NOTES**  
DRAWING SCALE AS NOTED. WRITTEN DIMENSIONS SHALL TAKE PRECEDENCE OVER SCALED DIMENSIONS.

THIS IS NOT A BOUNDARY SURVEY. BOUNDARY INFORMATION DEPICTED HAS BEEN OBTAINED FROM HUMBOLDT COUNTY 2015 GIS DATA. NORTHPOINT CONSULTING GROUP, INC. HAS NOT VERIFIED THIS PROPERTY BOUNDARY.

# NEW EARTH FARMS, LLC SITE MANAGEMENT PLAN

APN: 522-024-001

**LEGEND:**

	STREAM CROSSING
	DITCH RELIEF CULVERT
	ROCKED DIP
	INBOARD DITCH
	ROLLING DIP
	ROCKSLIDE
	ROCKED FORD CROSSING
	SPRING
	EXISTING
	PROPOSED

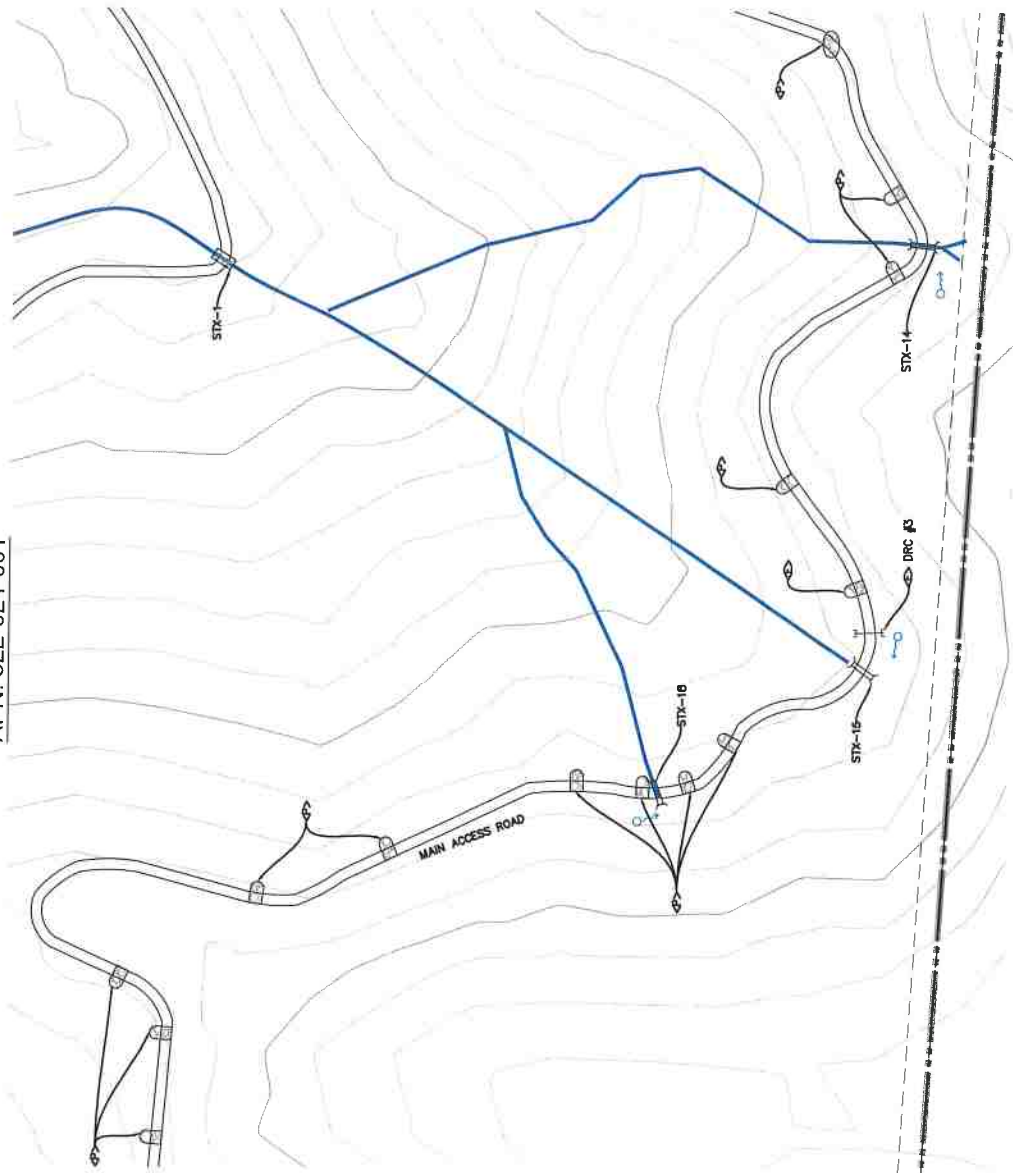

**AREA 1 MAP**  
22x34 SHEET: 1"=50'  
11x17 SHEET: 1"=100'

DATE	DESCRIPTION

**NORTHPOINT CONSULTING GROUP, INC.**  
317 3rd Street, Ste 15 Eureka, CA 95501

NEW EARTH FARMS, LLC / APN:522-024-001  
OLD 3 CREEKS ROAD WILLOW CREEK, CA 95573  
AREA 1 MAP

PROJECT NO. 202  
DATE 06/20/20  
SCALE 1"=100'  
SHEET 1 OF 1  
**SMP1**  
18-123

# NEW EARTH FARMS, LLC SITE MANAGEMENT PLAN

APN: 522-024-001

**LEGEND:**

	STREAM CROSSING
	DITCH RELIEF CULVERT
	ROCKED DIP
	INBOARD DITCH
	ROLLING DIP
	ROCKSLIDE
	ROCKED FORD CROSSING
	SPRING
	EXISTING
	PROPOSED
	SRA TURNOUT

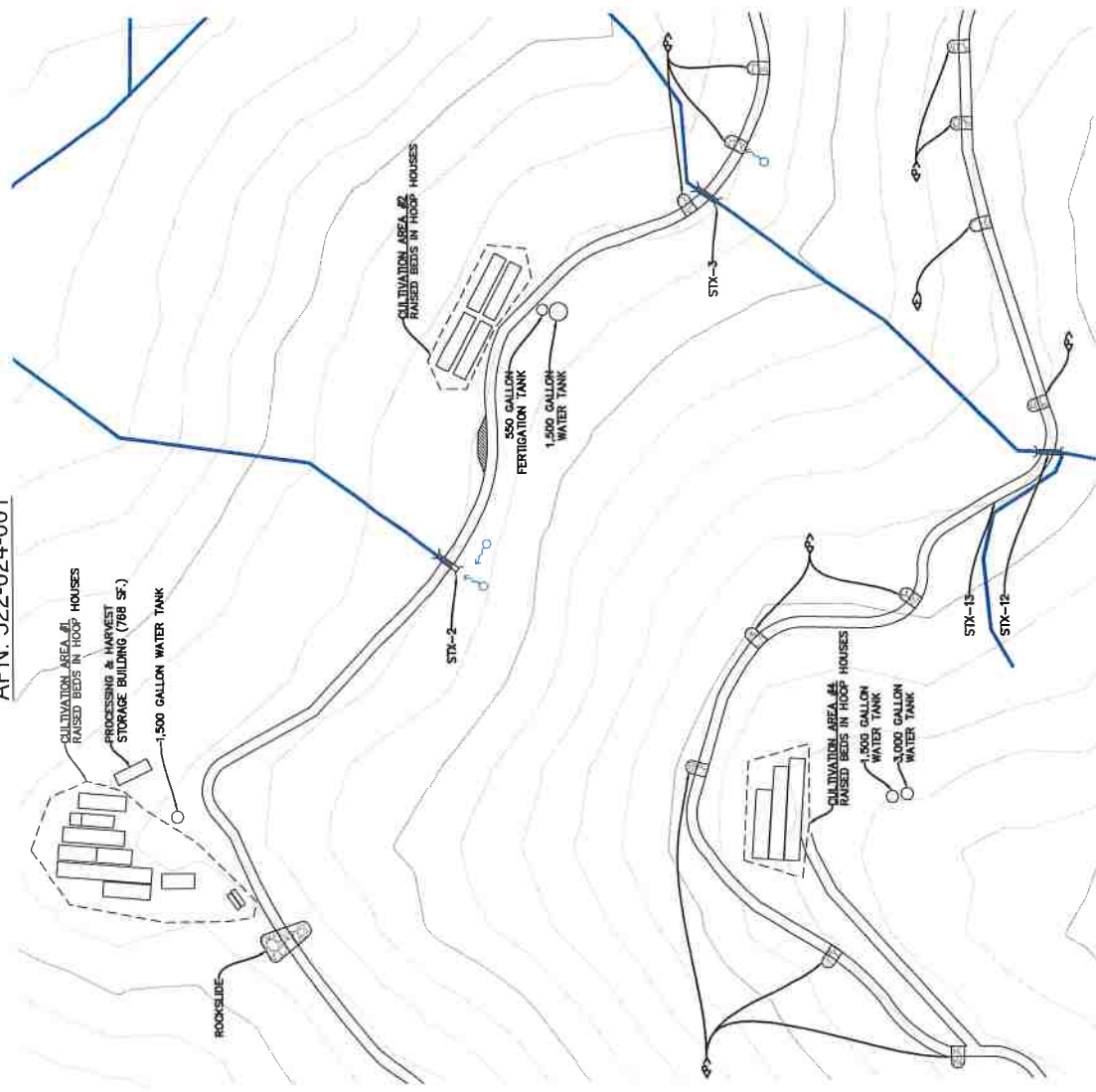

**AREA 2 MAP**  
 22x34 SHEET: 1"=80'  
 11x17 SHEET: 1"=160'  
 0 50 100

NEW EARTH FARMS, LLC / APN:522-024-001		OLD 3 CREEKS ROAD WILLOW CREEK, CA 95573		AREA 2 MAP	
NORTHPOINT CONSULTING GROUP, INC. 317 3rd Street, Ste 15 Eureka, CA 95501		DATE: 06/27/21		SHEET: SMP2	
DRAWN: [Blank]		SCALE: [Blank]		JOB NO.: [Blank]	





# NEW EARTH FARMS, LLC SITE MANAGEMENT PLAN

APN: 522-024-001

LEGEND:	
	STREAM CROSSING
	DITCH RELIEF CULVERT
	ROCKED DIP
	INBOARD DITCH
	ROLLING DIP
	ROCKSLIDE
	ROCKED FORD CROSSING
	SPRING
	EXISTING
	PROPOSED

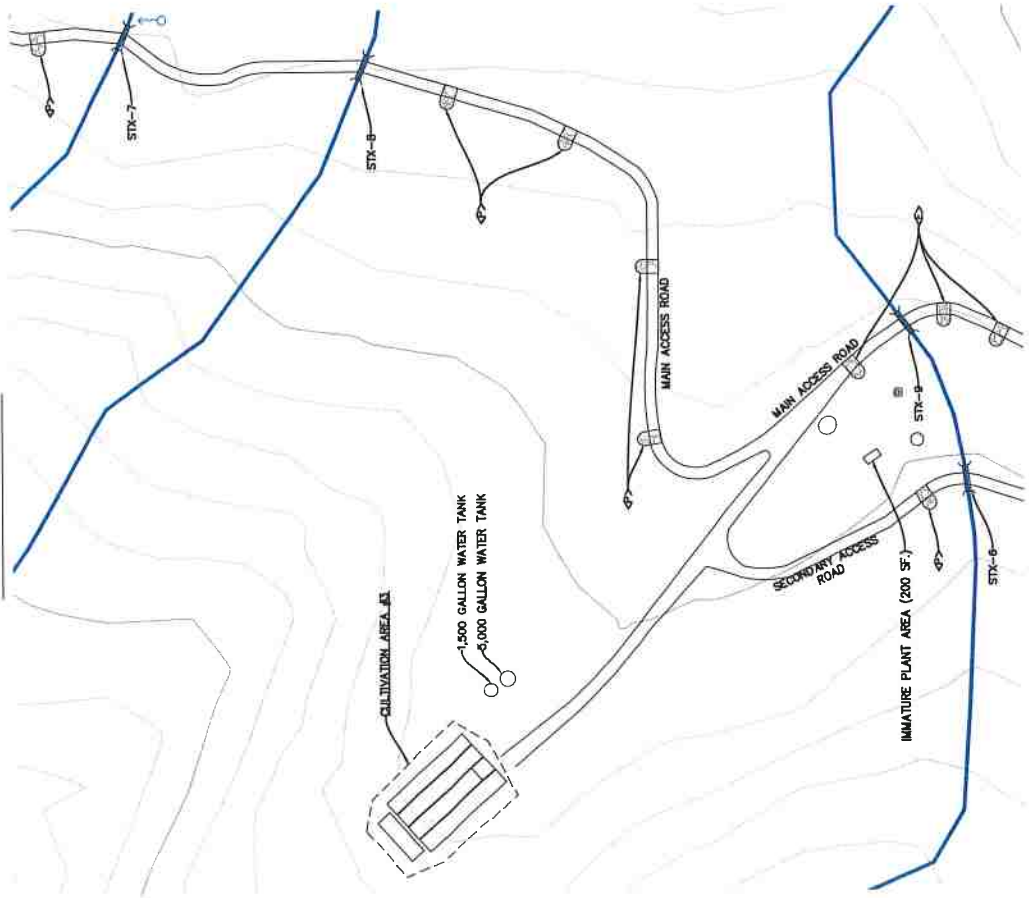

**AREA 4 MAP**  
 22x34 SHEET: 1"=75'  
 11x17 SHEET: 1"=150'  
 0 75 150

<b>NORTHPOINT</b> CONSULTING GROUP, INC. 317 3rd Street, Ste. 15 Eureka, CA 95501		NEW EARTH FARMS, LLC / APN:522-024-001 OLD 3 CREEKS ROAD WILLOW CREEK, CA 95573 AREA 4 MAP		SHEET: <b>SMP4</b> 16 of 122
---	--	--	--	------------------------------------



# Appendix B: Disturbed Area Map





# Appendix C: BPTC Implementation and Maintenance Schedule





# Appendix D: BPTC Measure Specification

## **Table of Contents**

RD1.1 Modified Low Water Rock Ford
RD1.2 Fords
RD1.3 Outsloped Roads w/ Inboard Swale
RD1.4 Outsloped Road
RD1.5 Inslope Road
RD1.6 Thru Cut Road
RD1.7 Critical Dips
RD1.8 Rolling Dip
RD1.9 Grading Unpaved Road Surfaces
RD1.10 Water Bars
RD1.11 Ditch Relief Culverts (DRC)
RD1.12 Stream Crossing Installation
RD1.13 Drainage for Unpaved Roads
RD1.14 Road Surface Upgrade
RD1.15 Routing and Location
RD1.16 Understanding Road Removal
RD1.17 Road Closure
EC1.1 Jute Mat Blanket
EC1.2 Culvert Outlet Energy Dissipater
EC1.3 Outlet Protection
EC1.4 Stockpile Management
SS-6 Straw and Mulch
SS-7 Geotextiles, Mats, Plastic Covers, and Erosion Control Blankets
SS-10 Outlet Protection
SS-11 Slope Drains
SC1.1 Check Dams
SC1.2 Sediment Basin
SC1.3 Fiber Rolls
Road BMP Resources



# RD-1.1 MODIFIED LOW WATER ROCK FORD

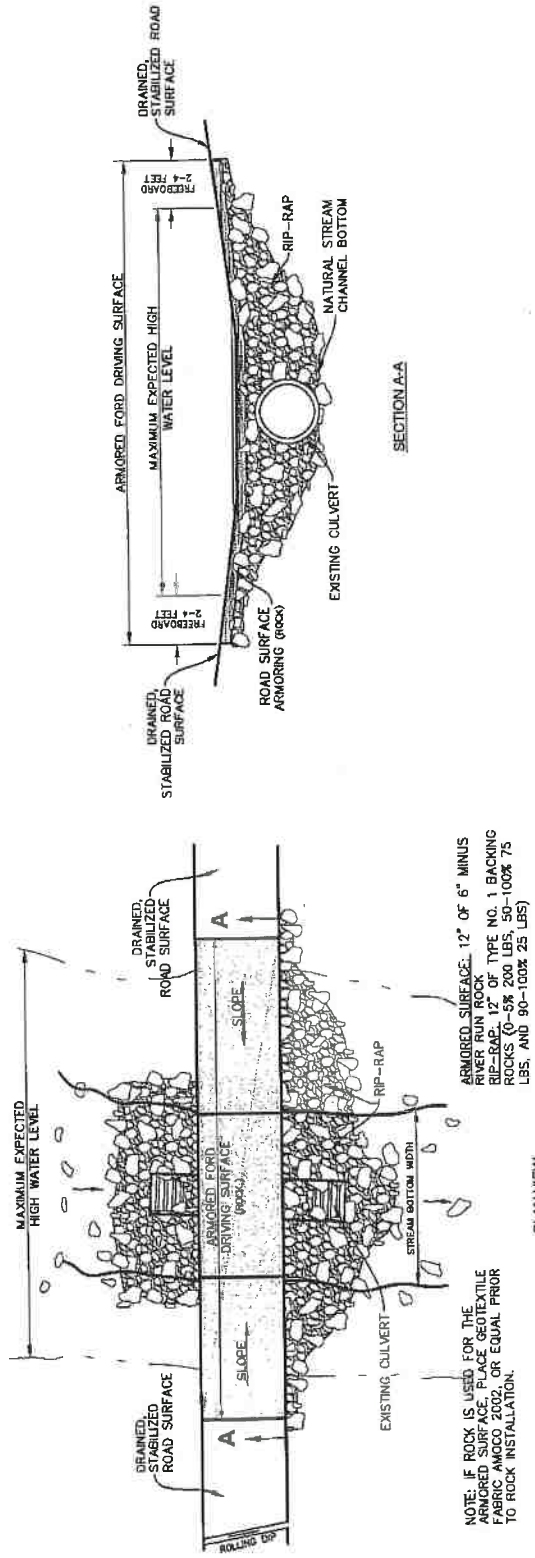

PLAN VIEW

SECTION A-A

## RD-1.2 FORDS

### DESCRIPTION

Fords work well on small to medium sized streams where there is a stable stream bottom and traffic is light. However, "construction" of fords and other unimproved stream crossings on well traveled roads should be avoided where water is flowing because of their potential to impact water quality. In certain situations, where flash floods, high seasonal flood peaks or floating debris are problems, fords may be a practical answer for crossing a poorly incised, shallow stream.

### BEST MANAGEMENT PRACTICES

- Fords in flowing streams, called "wet fords," are typically composed of streambed gravels, fill, or concrete structures built in contact with the streambed so that vehicles can cross the channel (Figure 1).
- Fords should be designed to allow low summer flows seep through the fill, and high water discharges flow over the top (Figure 2).
- Paving fords across flowing streams may be necessary to maintain water quality if there is to be regular traffic. Paving consists of a concrete, slightly dish-shaped slab across the watercourse, and a discharge apron or energy dissipater on the downstream side to prevent scour during high flows.
- On small, poorly incised, ephemeral or intermittent streams a ford may be needed if there is insufficient channel depth to install a culvert. In fact, a rock lined rolling dip with a rock apron face is generally desirable to permanent culverts on these swales and small watercourses. Fords have the advantage, over culverted fills, of never plugging.
- Fords on small streams should be rock armored to prevent erosion of the road surface and fill during periods of runoff. The fill face on the downstream side of the fill can either be protected with rock armor or fitted with a large overside drain (berm drain) to prevent erosion (Figure 3).
- Unimproved fords, which consist of a stream channel that has been filled with a substantial quantity of soil and left unprotected by armor or surfacing is a hazard to water quality and should not be constructed.

*Figure 1. Wet ford on Class II perennial stream. Clean rock aggregate has been imported for the travelling surface and coarse rock armor protects the outer edge of the road bed. It is important that rock aggregate used in a ford be large enough to resist transport during winter flows. Fords should not be used if high winter flows would cut off access to inspect and maintain drainage structures further out the road. From Weaver and Hagans (1994).*

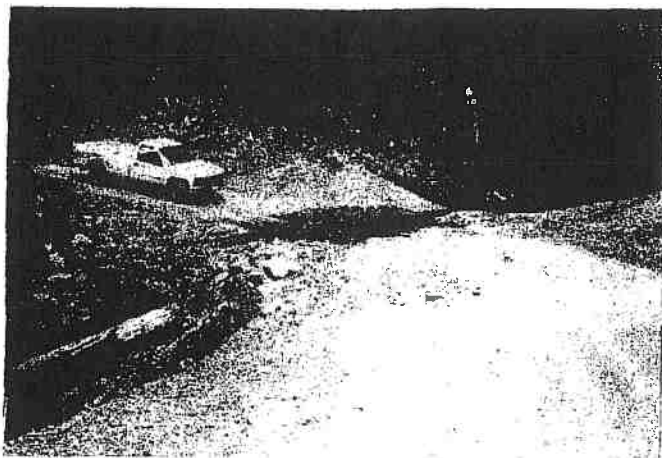

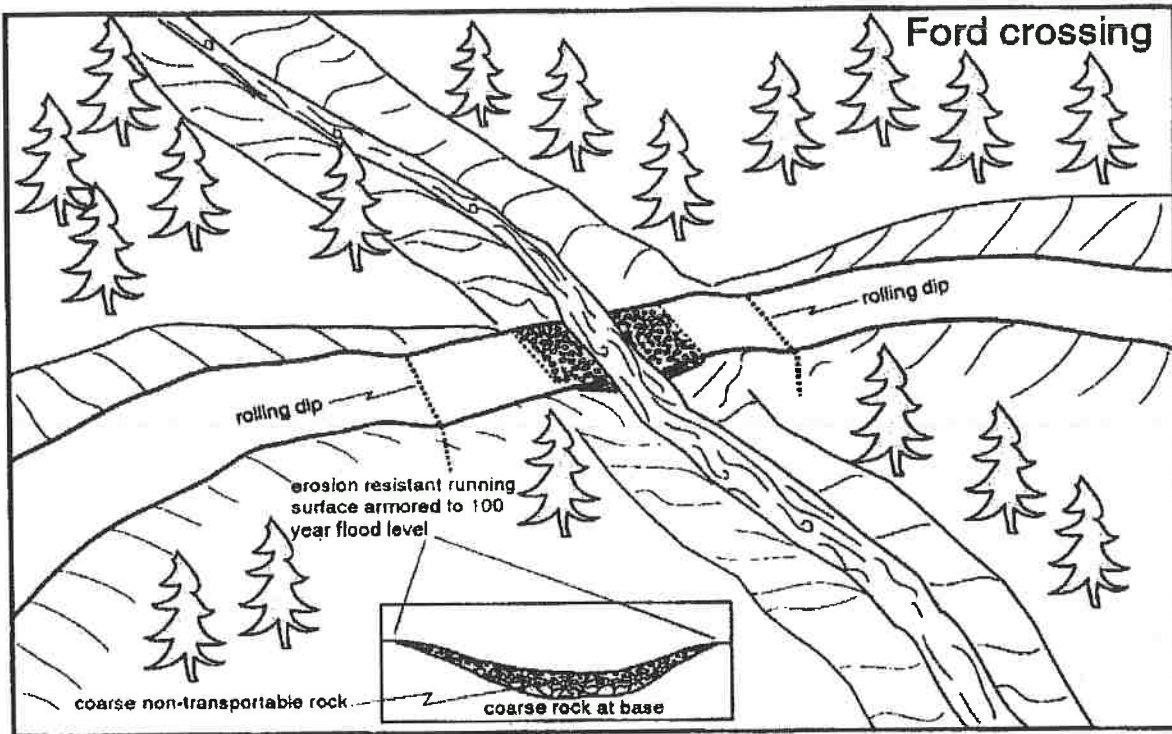

Figure 2. Typical ford stream crossing. From CDFG (2006).

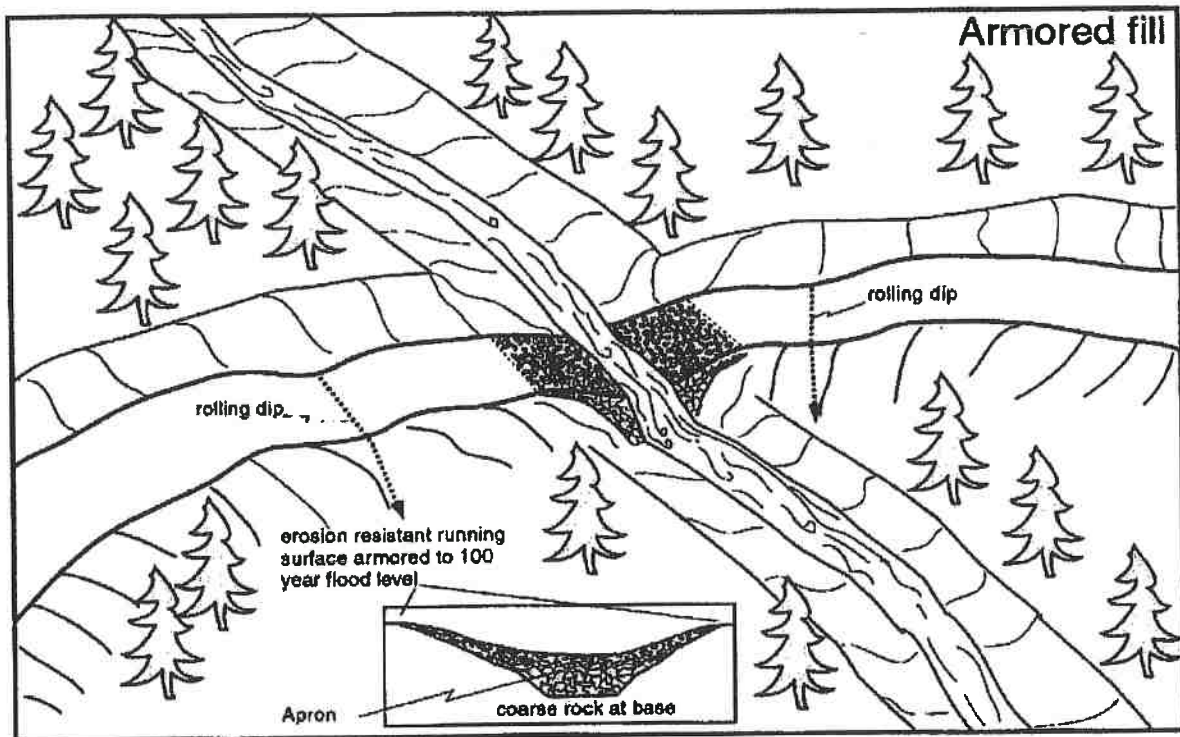

Figure 3. Typical armored stream crossing. From CDFG (2006).

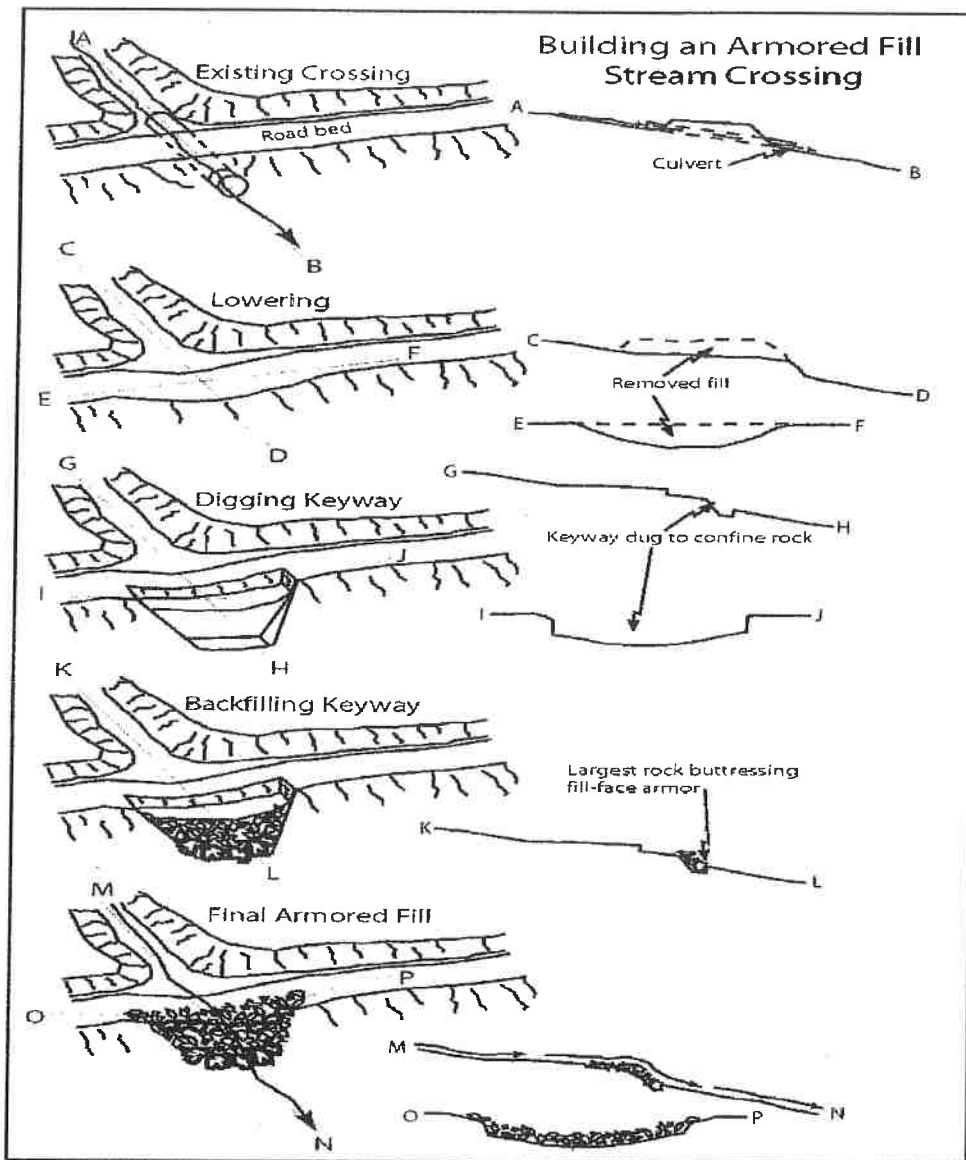

Figure 4. Design elements of a typical armored fill crossing. Note: where geotextile fabric may interfere with passage of amphibians in any Class 2 or 3 crossing, bury geotextile fabric with at least 6 inches of rock. Do not expose geotextile fabric in the bed of fish-bearing stream channels. From CDFG (2206).

**Source Material for Road BMP RD-2.7 Fords**

2006. California Department of Fish and Game. Part X - Upslope Erosion Inventory and Sediment Control Guidance, California Salmonid Stream Habitat Restoration Manual.

1994. Weaver W.E. and D.K. Hagans. Handbook for Forest and Ranch Roads. Mendocino County Resource Conservation District

# RD-1.3 OUTSLOPED ROAD W/ INBOARD SWALE

NOTE: ALL ROAD WIDTHS TO BE 12' MINIMUM AND ROCKED/REINFORCED WITH 2" MINIMUM AGG. BASE FROM ON SITE SOURCE

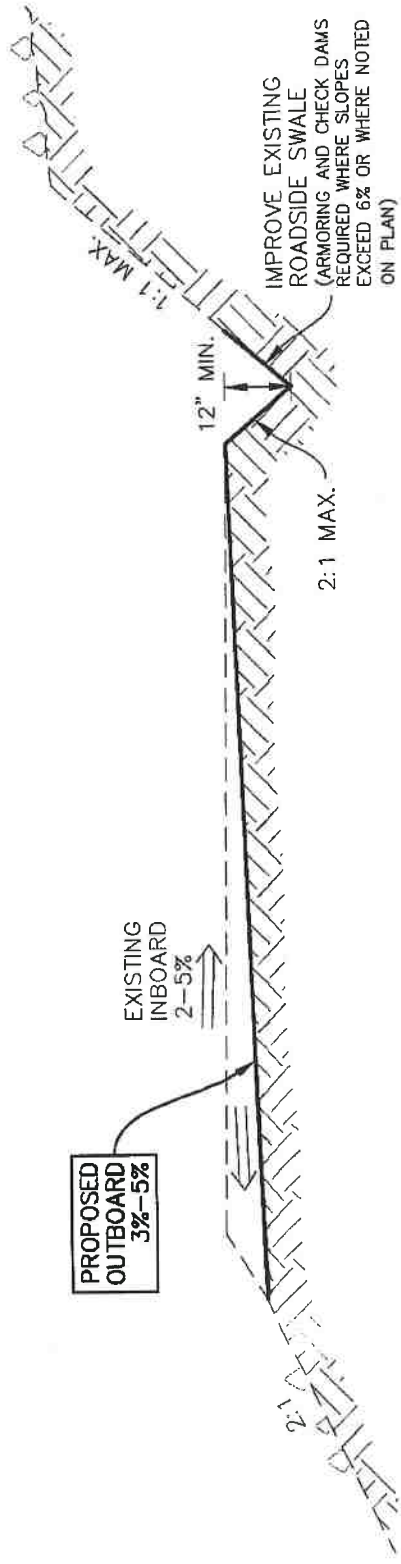

OUTSLOPE ROAD W/ INBOARD SWALE

# RD-1.4 OUTSLOPED ROAD

NOTE: ALL ROAD WIDTHS TO BE 12' MINIMUM AND ROCKED/REINFORCED WITH 2" MINIMUM AGG. BASE FROM ON SITE SOURCE

NOTE: ALL ROAD WIDTHS TO BE 12' MINIMUM

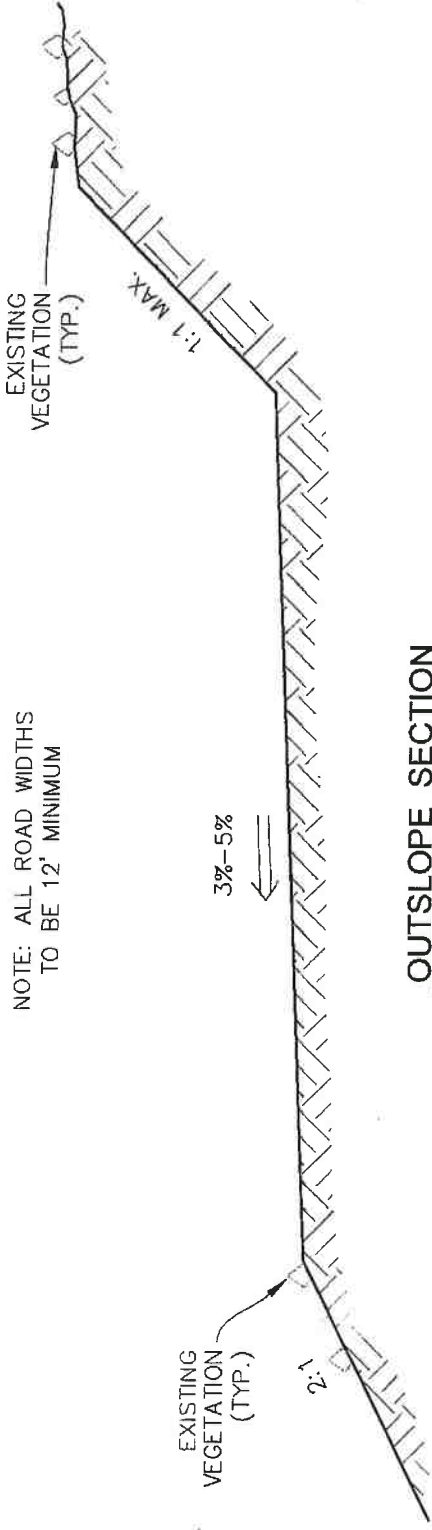

OUTSLOPE SECTION

# RD-1.5 INSLOPE ROAD

NOTE: ALL ROAD WIDTHS  
TO BE 12' MINIMUM AND  
ROCKED/REINFORCED WITH  
2" MINIMUM AGG. BASE  
FROM ON SITE SOURCE

NOTE: ALL ROAD WIDTHS  
TO BE 12' MINIMUM

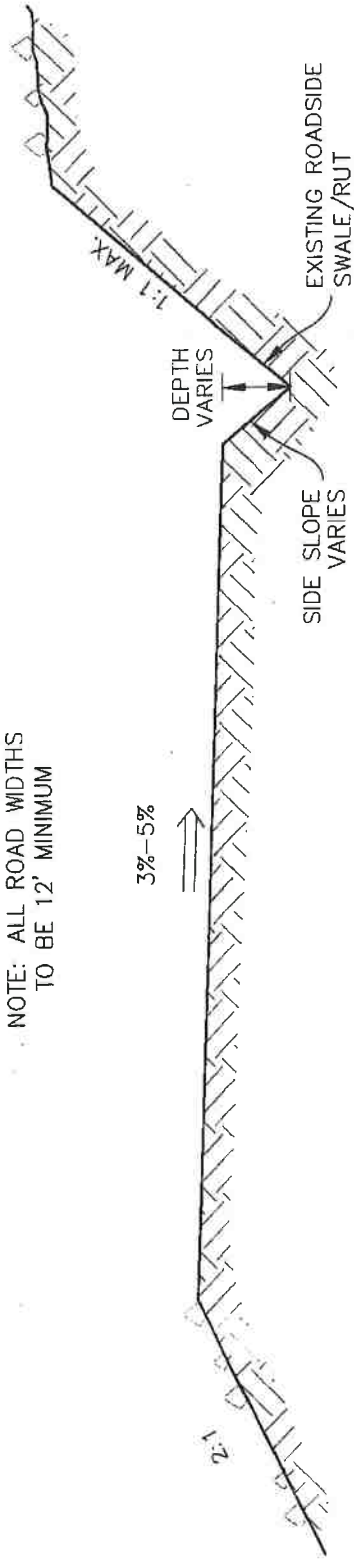

## INSLOPE SECTION

# RD-1.6 THRU CUT ROAD

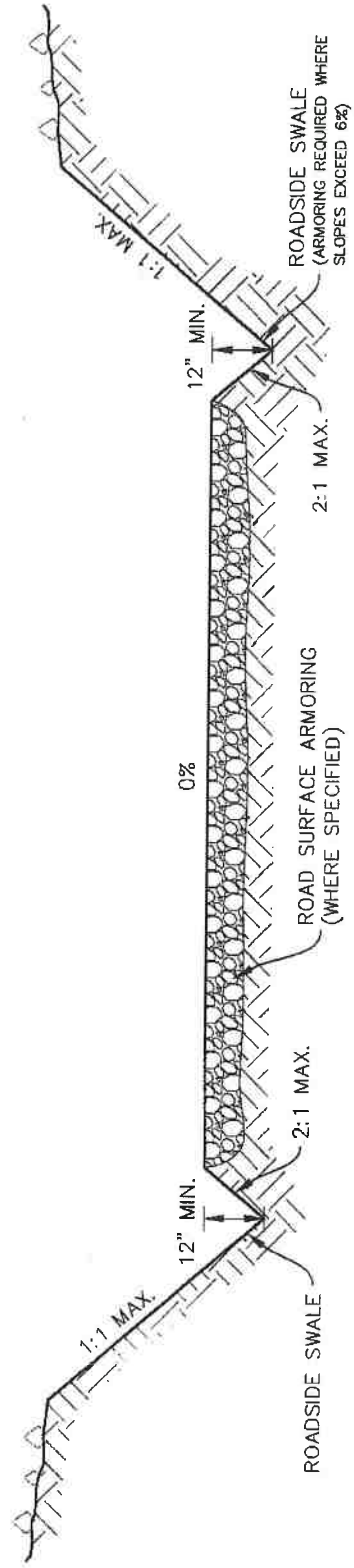

NOTE: IF ROCK IS USED FOR THE ARMORED SURFACE, PLACE GEOTEXTILE FABRIC AMOCO 2002, OR EQUAL PRIOR TO ROCK INSTALLATION.

ARMORED SURFACE, 12" OF CLASS 2 AGGREGATE BASE (3" MINUS, WELL GRADED AND LESS THAN 5% CLAYS)



## RD-1.7 CRITICAL DIPS

### DESCRIPTION

A critical dip is a rolling dip constructed on or close to the down-road hinge-line of a stream crossing, displaying a diversion potential. Build a critical dip at all stream crossings in order to prevent stream diversions when a culvert plugs and water flows out onto the road. Construction may be similar to Road BMP RD-1.8 Rolling Dips.

### BEST MANAGEMENT PRACTICES

- Stream crossings should be constructed to prevent diversion of flood overflow if the culvert were to become plugged. This can be done by designing the road to dip into and out of the stream at the crossing site or by installing a broad rolling dip on the down-road side of the crossing. This will allow the overflow to be directed back into the natural stream channel (Figure 1).
- Critical dips should be designed to handle the 100-year flow event for the stream it is installed at.
- Road surface and fill slopes at the critical dip should be rocked or otherwise stabilized.
- Must be deep enough that it is not obliterated by normal grading, but not so deep that it is difficult to negotiate or a hazard to normal traffic (Table 1).
- See Road BMP RD-1.8 Rolling Dips for more details.

Road grade %	Upslope approach (distance from up-road start of rolling dip to trough) (ft)	Reverse grade (distance from trough to crest) (ft)	Depth below average road grade at discharge end of trough (ft)	Depth below average road grade at upslope end of trough (ft)
<6	55	15-20	0.9	0.3
8	65	15-20	1.0	0.2
10	75	15-20	1.1	.01
12	85	20-25	1.2	.01
>12	100	20-25	1.3	.01

Table 1. Table of rolling dips dimensions. Design principles apply to critical dip. From CDFG (2006).

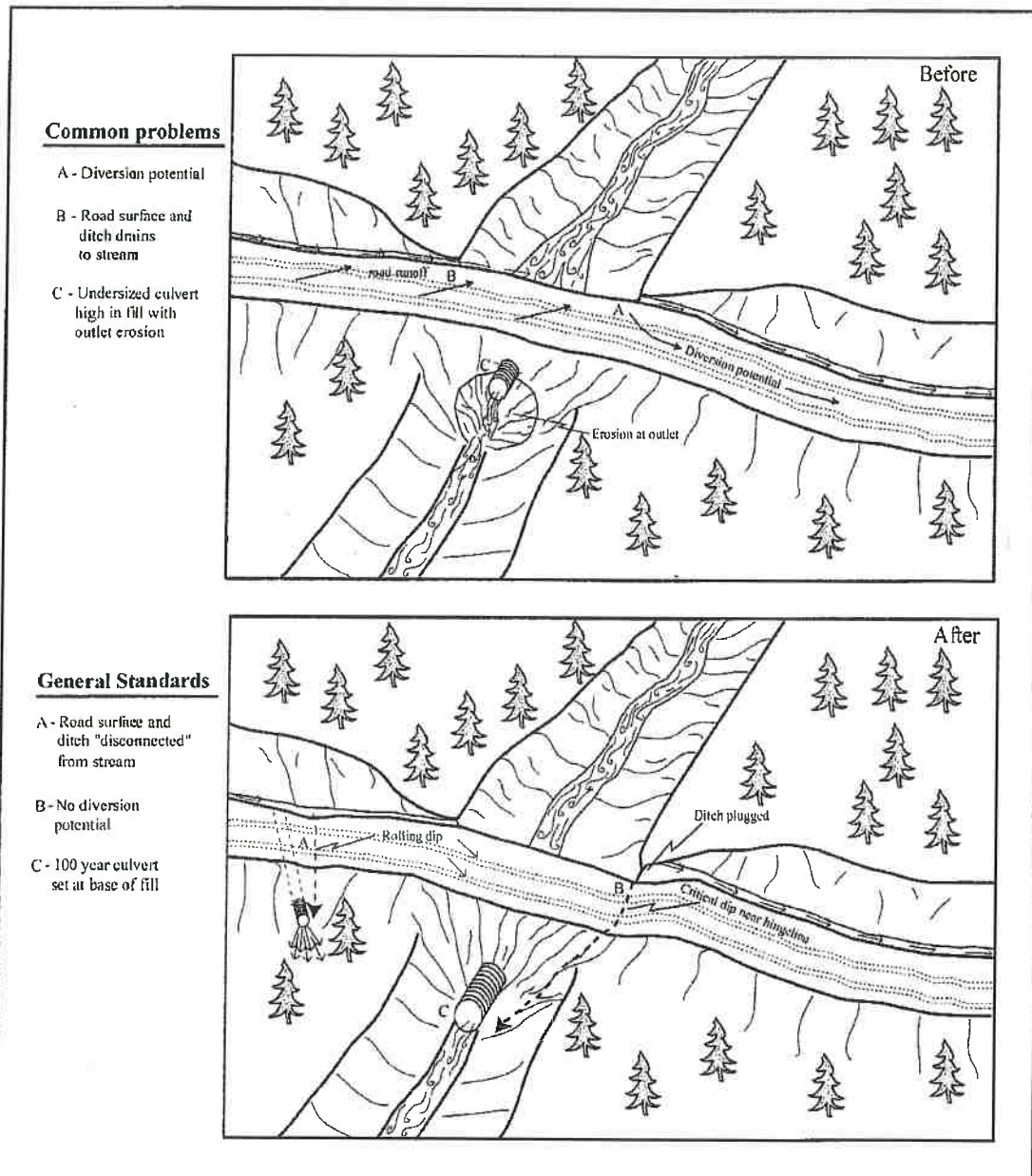

Figure 1. Install critical dips to prevent diversion prevention at stream crossings. Critical dips should be designed to handle the flow from a 100-year storm event. From CDFG (2006).

**Source Material for Road BMP 2.9 Critical Dips**

2006. California Department of Fish and Game. Part X - Upslope Erosion Inventory and Sediment Control Guidance, California Salmonid Stream Habitat Restoration Manual.

2004. FishNet 4C. Guidelines for Protecting Aquatic Habitat and Salmon Fisheries for County Road Maintenance.

# RD-1.8 ROLLING DIP

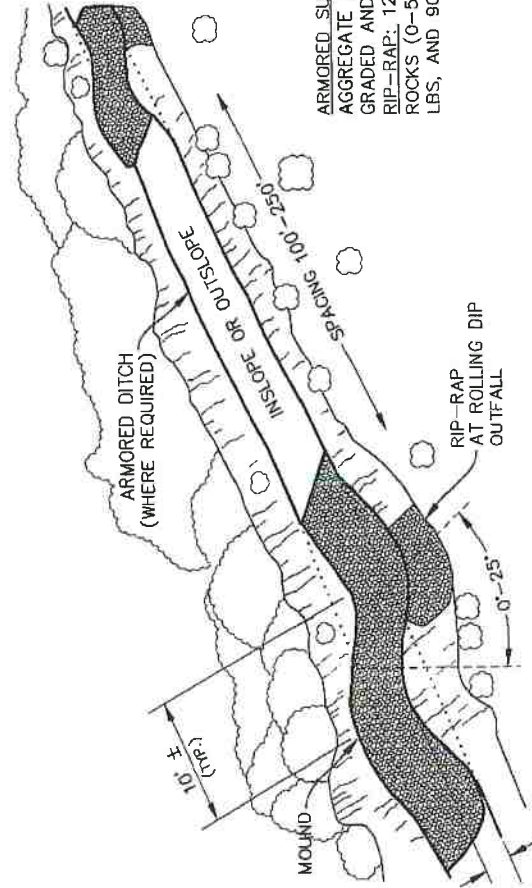

TABLE 1: ROLLING DIP, AND DITCH RELIEF CULVERT RECOMMENDATIONS

ROAD GRADE (%)	SOIL ERODIBILITY EROSIVE SOILS (FT)
0-3	250
4-6	160
7-9	130
10-12	115
12+	100

ARMORED SURFACE: 12" OF CLASS 2 AGGREGATE BASE (3" MINUS, WELL GRADED AND LESS THAN 5% CLAYS) RIP-RAP, 12" OF TYPE NO. 1 BACKING ROCKS (0-5% 200 LBS, 50-100% 75 LBS, AND 90-100% 25 LBS)

6" ± (DIP OR MOUND)  
 NOTE: PORTIONS ARE EXAGGERATED FOR CLARITY

## ROLLING DIP DETAIL NOT TO SCALE

## **RD-1.9 GRADING UNPAVED ROAD SURFACES**

### **DESCRIPTION**

Good maintenance practices on unpaved road surfaces prevent roadway erosion, deterioration or failure; helps with sediment and dust control, and provides a safe roadway surface for the traveling public.

### **BEST MANAGEMENT PRACTICES**

- Fit grading to the surrounding terrain.
- Blade and compact a smooth surface and compact loose soils as needed.
- Crown or slope the road to avoid ponding or concentration of runoff. Outslope all roads where possible and safe.
- Preserve existing vegetation to the greatest extent feasible.
- Minimize the length and steepness of slopes.
- Maintain natural drainage patterns in watershed.
- Preserve or improve surface drainage in the vicinity of the road.
- Disconnect road drainage features from watershed hydrology.
- Make sure drainage is self-maintaining.
- Keep runoff velocities low, using energy dissipating control measures.
- Minimize amount of road-related sediment that gets into watercourses.
- Prevent dust abatement chemicals from getting into watercourses or riparian areas.

### **SEASONAL CONCERNS**

- Perform routine road surface maintenance during the dry season. Avoid working in wet conditions and during the wet season (October 15- April 15), except for emergencies. Disturbed soil combined with rainfall, greatly increase the risk of exposed sediment runoff into streams.
- Inspect roads and associated drainage facilities for signs of erosion or deterioration at least twice annually with at least one inspection during or after first storm events of the season with additional follow-up for severe storm events. Inspect all road and drainage facilities after a large storm event. Note locations of road surfaces, drainage features, cutslopes and fillslopes that appear to be failing and contributing sediment to streams in order to prioritize maintenance or repair.

**SPOILS AND SIDECASTING**

- Avoid sidecasting of soil in all cases where it could be delivered into a watercourse, riparian area, roadside ditch or storm drain. In some instances, under the following guidelines (Table 1), sidecasting is allowable given remote distances from spoils storage sites. In these cases, the setback distance required depends on slope and vegetation. The presence of vegetation helps to slow the travel of sediment downslope, so good judgment is needed to assess the situation. *Do not sidecast at all* if the slope is sparsely vegetated and it appears that sediment will travel with rain runoff into a stream or estuary system, even if setback distances are applied. On slopes of 5:1 (20% gradient) or less, sidecasting is allowed beyond 150 feet of a watercourse, stream crossing, riparian area, roadside ditch or storm drain. On 2:1 slopes (50%) or less, sidecasting is allowed beyond 300 feet of a watercourse, stream crossing, riparian area, roadside ditch or storm drain. On slopes greater than 2:1, typically sidecasting is *not recommended*, however there may be rare instances on slopes greater than 2:1 where sidecasting is acceptable given very long distances from waterbodies and good vegetative cover. Seek advice from local fisheries agency staff when in doubt. Avoid concentrating sidecasting repeatedly in the same place. Never sidecast large amounts of soil from major landslides.
- Temporary spoils stockpiles should be located in areas that are relatively level; relatively free of vegetation and away from streams and wetlands areas (see Erosion Control BMP EC-1.5 Stockpile Management). The primary concern is to keep stockpiled materials from eroding into stream or wetland systems. Apply erosion control BMPs when needed. Do not place temporary spoils piles at the top of unstable slopes or at the edges of slopes where water will carry sediment into watercourses. Remove temporary stockpiles to permanent disposal locations before the rainy season. If emergency work is conducted during the rainy season, remove stockpile as soon as feasible and before the next rain storm.

SLOPE GRADIENT	DISTANCE FROM WATERCOURSE, STREAM CROSSING, RIPARIAN AREA, ROADSIDE DITCH, STORM DRAIN	SIDECASTING RULE
Any slope	Appears that sediment will travel with rainwater into watercourse.	Not allowed
5:1 (20%) or less	150 feet or more	Allowed using good judgment
2:1 (50%) or less	300 feet or more	Allowed using good judgment
Greater than 5:1 (50%)	Vegetated slope long distance from watercourse	Allowed
Greater than 5:1 (50%)	Sparsely vegetated slope and it appears that sediment will travel with rain into watercourse	Not allowed

Table 1. Sidecasting guidelines. From: FishNet 4C (2004)

**BERMS**

- Do not leave loose soil piled in berms alongside the road or ditch. Loose or exposed soil berms are erodible and readily flushed into waterways and storm drains.
- If any berm is left in place for public safety reasons it must be compacted and stabilized with seeding or asphalt. Frequent well placed breaks in the berms are necessary to allow water to drain from road, preserving the natural drainage pattern of the slope.

**Source Material for Road BMP RD-3.2 Grading**

2004. FishNet 4C. Guidelines for Protecting Aquatic Habitat and Salmon Fisheries for County Road Maintenance.

2002. Five Counties Salmon Conservation Program. A Water Quality and Stream Habitat Protection Manual for County Road Maintenance.

## RD-1.10 WATERBARS

### DESCRIPTION

Waterbars are shallow, abrupt excavated dips or troughs with an adjacent, downslope hump or mounded berm, that are built at an oblique angle across the road (Figure 1 and 2). Waterbars are useful only on low standard seasonal or temporary, unsurfaced roads where winter use will not occur, because traffic easily cuts through the soft berm and fills the adjacent dip. Waterbars should be constructed at proper spacing according to the grade of the road (Table 3). Waterbars are usually regraded (smoothed out) at the beginning of each operating season, and then reconstructed at the beginning of each winter period.

Waterbars are high maintenance drainage structures that are prone to failure if not properly built and maintained. Unauthorized winter traffic is likely to break down waterbars and result in serious road surface erosion and water pollution.

### BEST MANAGEMENT PRACTICES

- Waterbars and rolling dips should be spaced along the road close enough together that the road surface is not gullied (Table 3). Appropriate spacing of surface drainage structures depends on soil credibility and runoff rates. Look at local roads to determine the maximum spacing that will work in your specific area.

Erosion Hazard Rating (for surface erosion)	Road or Trail Gradient (%)			
	10% or less	11-25%	26-50%	over 50%
Extremely high	100'	75'	50'	50'
High	150'	100'	75'	50'
Moderate	200'	150'	100'	75'
Low	300'	200'	150'	100'

Table 3. From Weaver and Hagans (1994). <sup>1</sup> Adapted from California Forest Practice Rules. This is the maximum distance between waterbars: when in doubt, reduce the spacing. Soils are nonrenewable and waterbars are inexpensive.

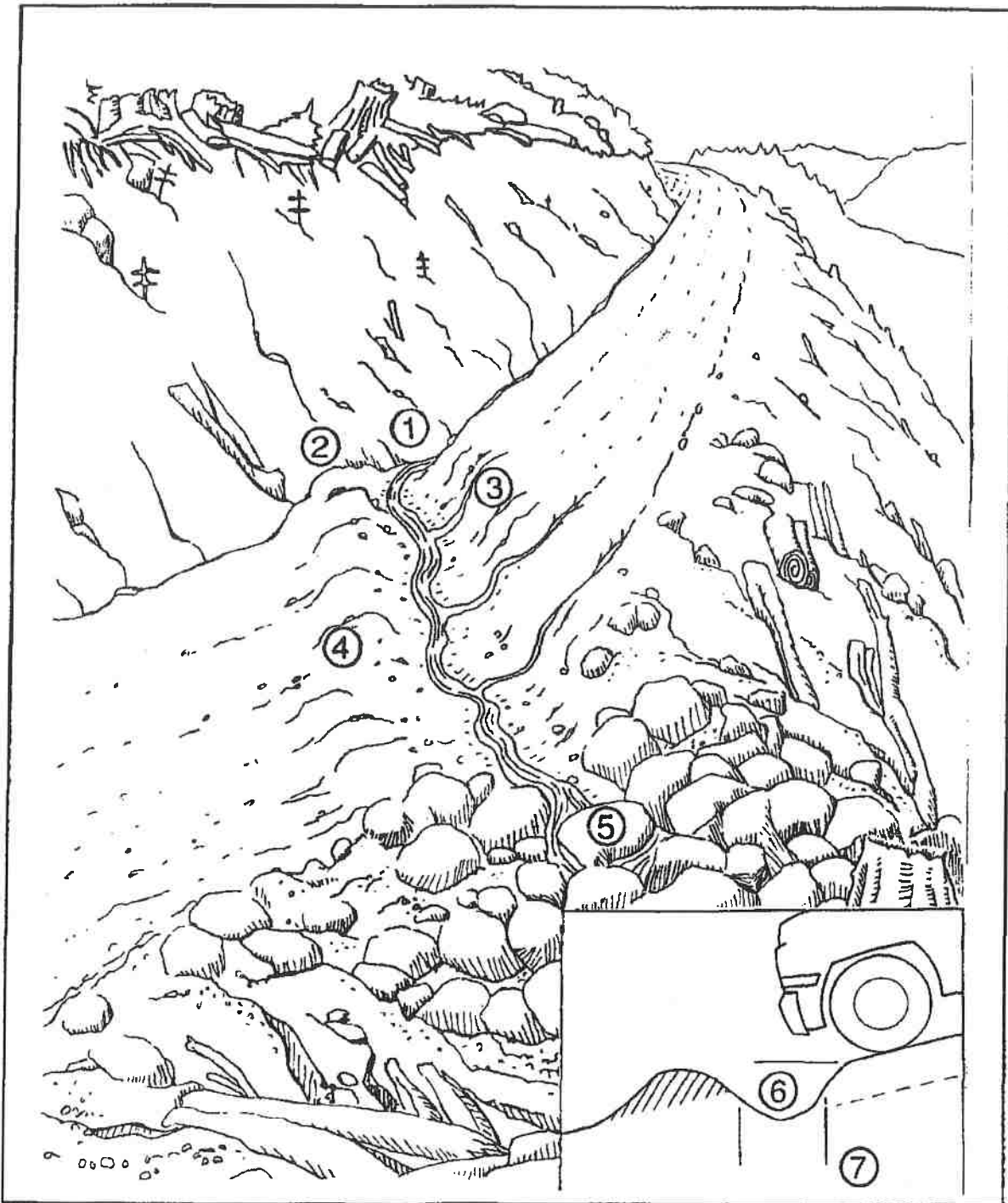

Figure 1. Waterbars are constructed on unsurfaced forest and ranch roads that will have little or no traffic during the wet winter period. The waterbar should be extended to the cutbank to intercept all ditch flow (1) and extend beyond the shoulder of the road. A berm (2) must block and prevent ditch flow from continuing down the road during flood flows. The excavated waterbar (3) should be skewed 30° to the ditch-line with the excavated material bermed on the downhill grade of the road (4). Water should always be discharged onto the downhill side on a stable slope protected by rip rap or vegetation (5). The cross ditch depth (6)



and width (7) must allow vehicle cross-over without destroying the function of the drain (B.C.M.F., 1991). From Weaver and Hagans (1994).

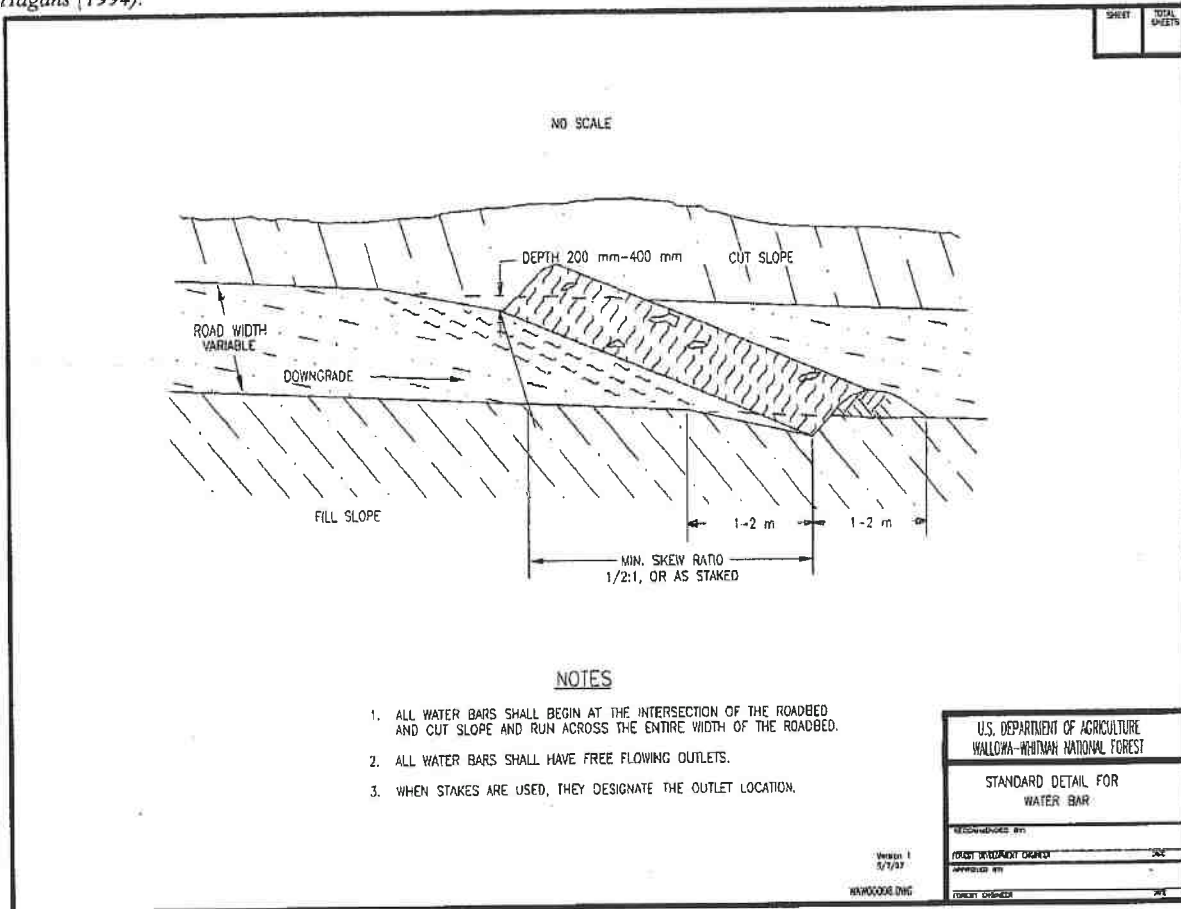

Figure 2. Typical design of a waterbar. From US Forest Service.

**Source Material for Road BMP RD-7.8 Waterbars**

1994. Weaver W.E. and D.K. Hagans. Handbook for Forest and Ranch Roads. Mendocino County Resource Conservation District

## **RD-1.11 DITCH RELIEF CULVERT** **INSTALLATION**

### **DESCRIPTION**

Ditch relief culverts (DRCs) divert water from an inside road ditch to an outside area beyond the outer edge of the road fill. DRCs take the flow through or beneath the road surface. Ditch relief culverts may also be used to filter water in a buffer zone prior to entering a waterway.

### **BEST MANAGEMENT PRACTICES**

- Culverts should be designed and installed at intervals along the road that are close enough to prevent erosion of the ditch and at the culvert outfall, and at locations where collected water and sediment is not discharged directly into watercourses (Table 1).
- Install ditch relief culverts at an oblique (typically 30 degree) angle to the road so that ditch flow does not have to make a sharp angle turn to enter the pipe (Figure 1). On low gradient roads (<5%), where ditch flow is slow, ditch relief culverts can be installed at right angles to the road.
- Ditches should *neither* be discharged directly into the inlet of a watercourse crossing culvert, nor should ditch relief culverts discharge into a watercourse via surface flow without first directing flow through an adequate filter strip (Figure 2).
- In addition to installing ditch relief culverts on either approach to watercourse crossings, it is also advisable to consider installing ditch drains before curves, above and below through-cut road sections, and before and after steep sections of the road.
- If the ditch is on an insloped or crowned road that is very close to a stream, consider using outsloping to drain the road surface (see Road BMP RD-1.3, 1.4 Outslope Road). The ditch and the ditch relief culvert would then convey only spring flow from the cutbank, and not turbid runoff from the road surface.
- Do not discharge flow from ditch relief culverts onto unstable or highly erodible hillslopes
- Culverts should be installed at the gradient of the original ground slope, so it will emerge on the ground surface beyond the base of the fill. If not, either the fill below the culvert outlet should be armored with rock, or the culvert should be fitted with an anchored downspout to carry erosive flow past the base of the fill (Figure 1).
- Downspouts longer than 20 feet should be secured to the hillslope for stability. Full round downspouts are preferred over half-round downspouts.

Table 1. Maximum suggested spacing for ditch relief culverts<sup>1</sup> (ft)

Road grade (%)	Soil credibility				
	very high	high	moderate	slight	very low
2	600-800 <sup>2</sup>				
4	530	600-800 <sup>2</sup>			
6	355	585	600-800 <sup>2</sup>		
8	265	425	525	600-800 <sup>2</sup>	
10	160	340	420	555	
12	180	285	350	460	600-800 <sup>2</sup>
14	155	245	300	365	560
16	135	215	270	345	490
18	118	190	240	310	435

<sup>1</sup>Adapted from Transportation Handbook USDA Forest Service, R-6, 1966. Culvert spacing may be too great in locations where ditch runoff is accumulated and discharged onto steep hillslopes that are prone to gullying. Spacing is designed to control ditch erosion, not culvert outfall erosion, and are based on 25-year storm and precipitation rate of 1-2 in/hr for 15 minutes. If less, multiply by the intensity 0.50, 0.30, etc. If 2-3 in/hr, divide distance in table by 1.50; if 3-4 in/hr, divide by 1.75; and if 4-5 in/hr, divide by 2.00. The U.S. Forest Service also publishes abundant information on preventing and controlling gully erosion below culvert outfalls. From Hagans and Weaver (1994).

<sup>2</sup>Even with stable ditches, ditch relief culvert spacing greater than about 600 to 800 feet is generally not recommended due to the large volume of road surface and cutslope runoff that would be discharged through the culvert and onto lower slopes during peak runoff periods. Culvert outlet erosion may occur with less than 800 feet of contributing ditch line, so observe local conditions to determine the upper limit of acceptable spacing in your area.

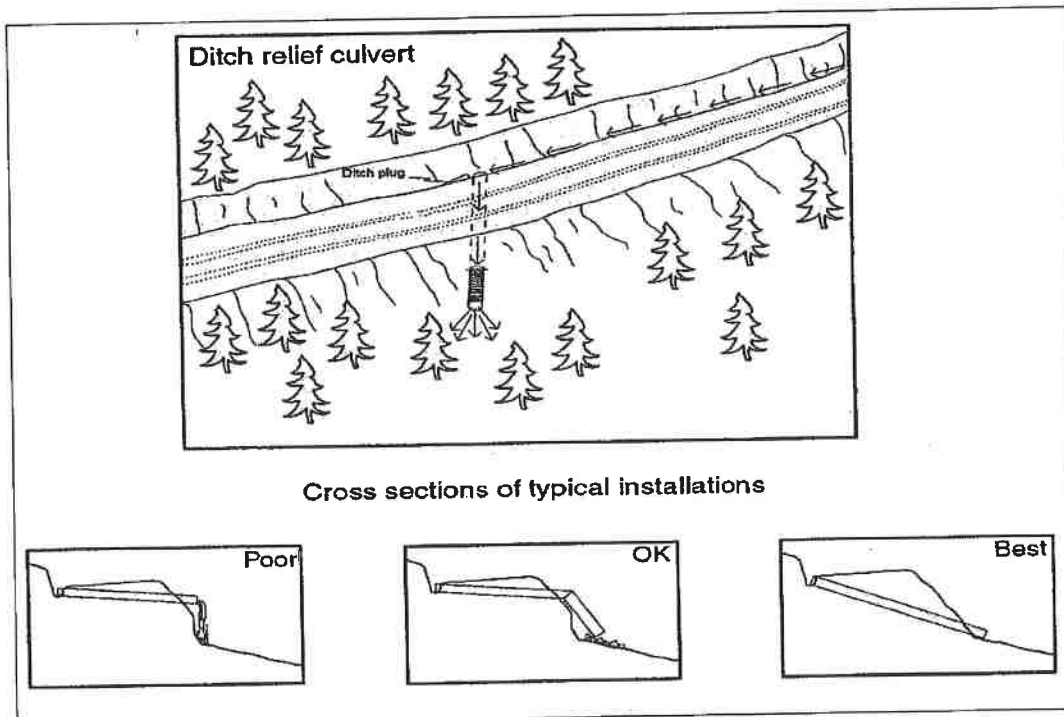

Figure 1. Typical ditch relief culvert installation. (CDFG, 2006)

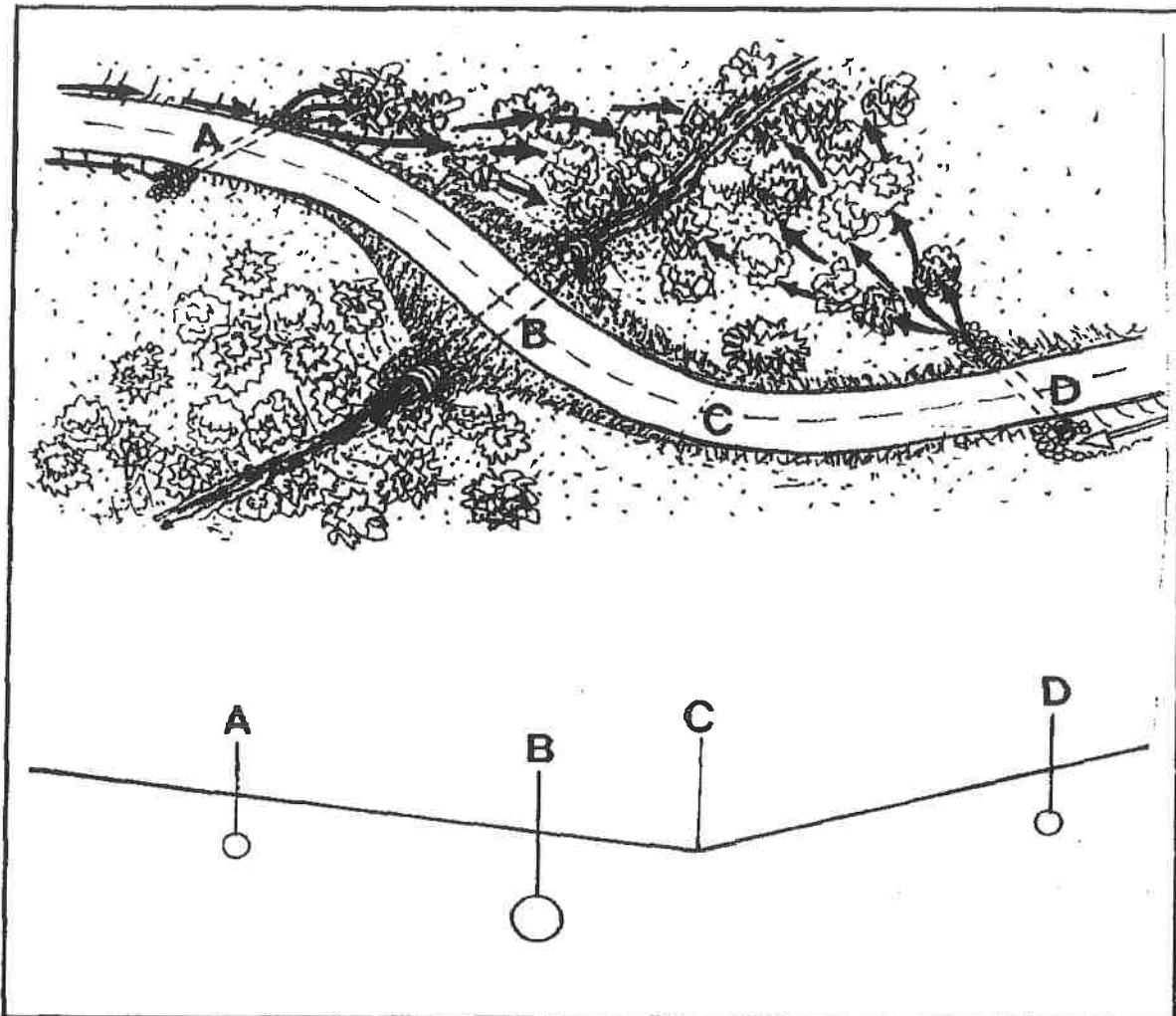

Figure 2. Where a road approaches a stream crossing (B), ditch flow should be culverted across the road (A,D) and discharged into a vegetated buffer that can filter the runoff before it reaches the watercourse. If the stream culvert plugs with debris or is topped by flood flows, flow will spillover the road at the change in grade at location "C" and back into the stream channel (modified from M.D.S.L. 1991). From Weaver and Hagans (1994).

**Source Material for Road BMP 2.10 Ditch Relief Culvert Installation**

2006. California Department of Fish and Game. Part X - Upslope Erosion Inventory and Sediment Control Guidance, California Salmonid Stream Habitat Restoration Manual.

2004. FishNet 4C. Guidelines for Protecting Aquatic Habitat and Salmon Fisheries for County Road Maintenance.

1994. Weaver W.E. and D.K. Hagans. Handbook for Forest and Ranch Roads. Mendocino County Resource Conservation District

## **RD-1.12 STREAM CROSSING INSTALLATION**

### **DESCRIPTION**

During road building, the construction of culverted stream crossings has the greatest potential of all activities to cause immediate sediment pollution. Culverts should be properly aligned, bedded, backfilled and covered, or they will be subject to eventual failure. In all cases, disturbance to the stream banks and streambed should be minimized during stream crossing construction.

### **BEST MANAGEMENT PRACTICES**

- Culverts should be aligned with the natural stream channel. Correct alignment is critical for the culvert to function properly. Misalignment can result in bank erosion and debris plugging problems (Figure 69a).
- Stream crossing culverts should be placed at the base of the fill, and at the grade of the original streambed (Figure 1) (Figure 69d).
- Culvert should be inset slightly into the natural streambed so that water drops several inches as it enters the pipe. Culvert inlets set too low can plug with debris and those set too high can allow water to undercut the culvert (Figure 69b). Culverts placed midway up the outside of the fill are more likely to plug with sediment or organic debris, because their ability to pass materials is reduced, or to cause erosion of the fill below the culvert outlet (Figure 1).
- The culvert bed may be composed of either compacted rock-free soil, or gravel. If gravel is used for the bed, filter fabric will be needed to separate the gravel from the soil to minimize the potential for soil piping. Bedding beneath the culvert should provide for even distribution of the load over the length of the pipe.
- Inlet and outlet of the culvert should be armored. A metal, concrete, sandbag or rock head-wall can be constructed to prevent inlet erosion. A trash protector can be installed just upstream from the inlet where there is a hazard of floating limbs and wood chunks plugging the culvert inlet. This is especially important on logging roads where the upslope areas have recently been harvested or are slated for harvesting in the future.
- Stream crossings that are not at grade can be retrofitted with a downspout with rock placed at the outlet for armoring against hillslope erosion.

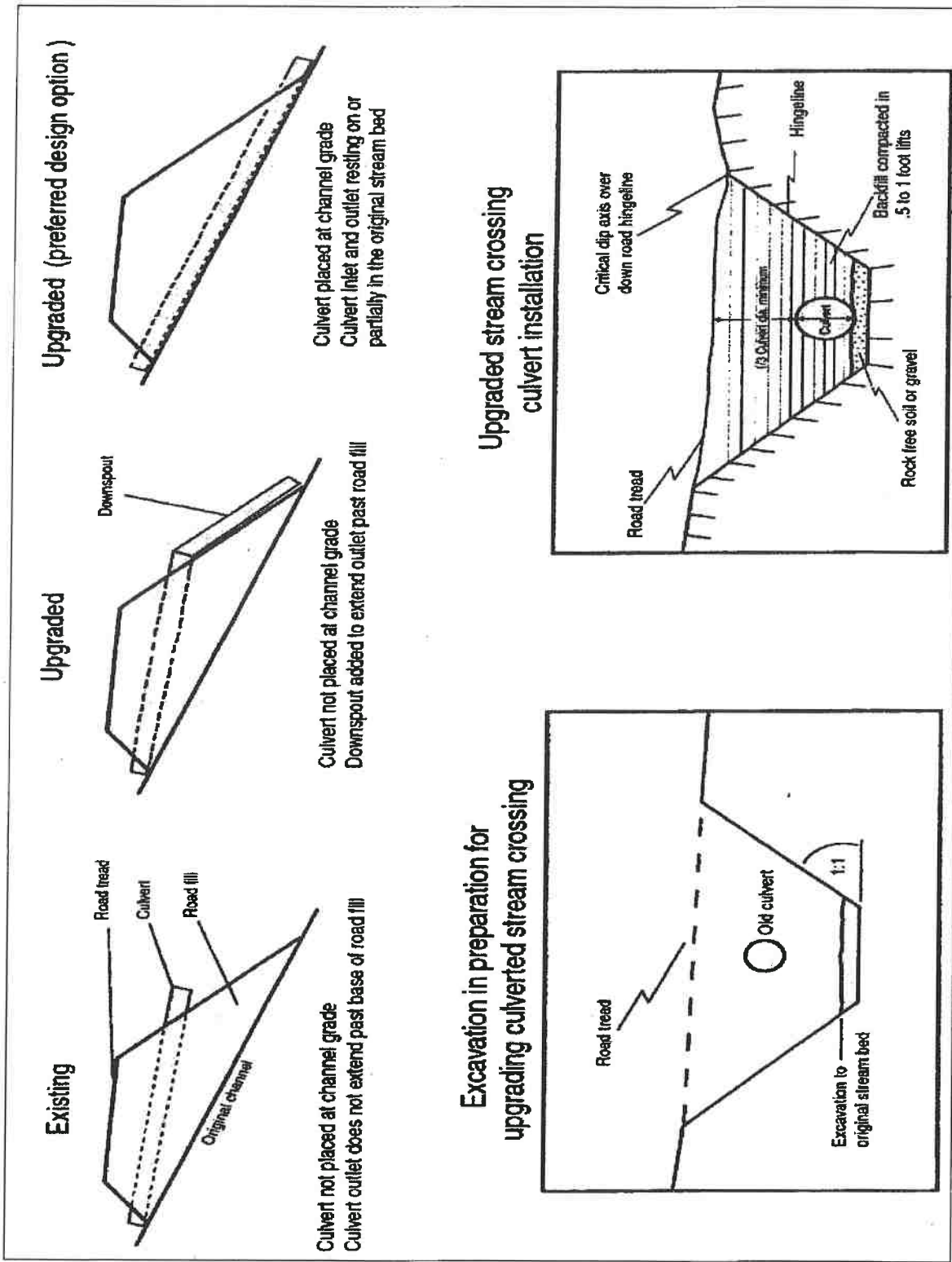

Figure 1. Typical stream crossing installation on non fish-bearing streams. From CDFG (2006).

Figure 69a, b. Proper culvert installation involves correct culvert orientation, setting the pipe slightly below the bed of the original stream, and backfilling and compacting the fill as it is placed over the culvert. Installing the inlet too low in the streambed (A) can lead to culvert plugging, yet if it set too high (B) flow can undercut the inlet (from M.D.S.L., 1991).

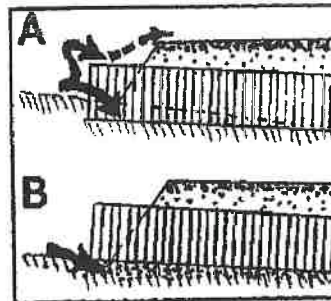

Figure 69c. If the culvert outlet is placed too high in the fill (C), flow at the outlet will erode the fill.

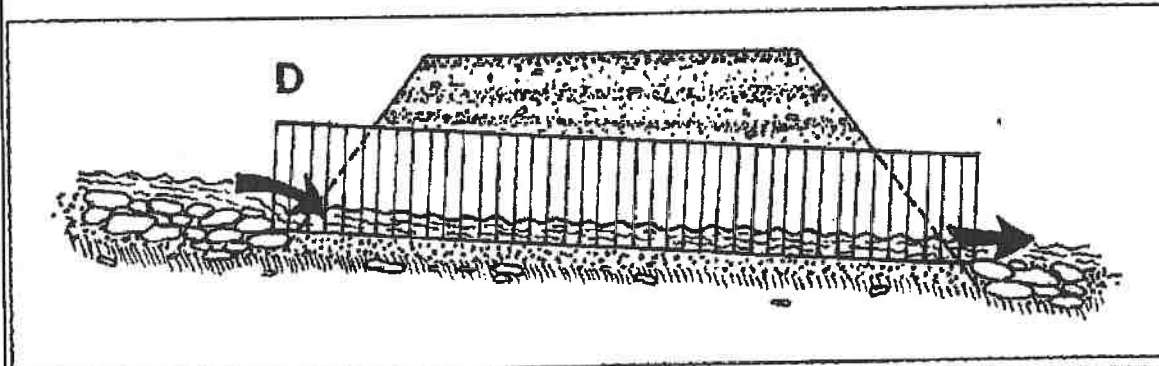
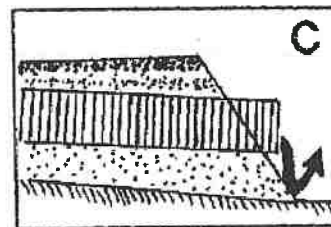

Figure 69d. Placed correctly (D), the culvert is set slightly below the original stream, grade and protected with armor at the inlet and outlet.

Figures 69a,b,c,d. Typical stream crossing installation. From Hagans and Weaver (1994).

#### Source Material for Road BMP RD-2.8 Stream Crossing Installation

2006. California Department of Fish and Game. Part X - Upslope Erosion Inventory and Sediment Control Guidance, California Salmonid Stream Habitat Restoration Manual.

1994. Weaver W.E. and D.K. Hagans. Handbook for Forest and Ranch Roads. Mendocino County Resource Conservation District

## **RD-1.13 DRAINAGE FOR UNPAVED ROAD SURFACES**

### **DESCRIPTION**

Roads should be designed and constructed to cause minimal disruption of natural drainage patterns. Provisions for two components of road drainage should be included in every road project: 1) road surface drainage (including drainage which *originates* from the cutbank, road surface, and fillslope); and 2) hillslope drainage (including drainage from large springs, gullies, and streams which *cross* the road alignment).

### **BEST MANAGEMENT PRACTICES**

- Maintain natural drainage patterns in watershed through installing drainage features to keep water within sub-basins.
- Crown or slope the road to avoid ponding or concentration of runoff. Outslope all roads where possible and safe (see Road BMP RD-1.3, 1.4 Outslope).
- Use rolling dips instead of ditch relief culverts (DRCs) when possible (Table 1) (Figure 1). Rolling dips require less maintenance and are less prone to failure than culverts (see Road BMP RD-1.8 Rolling Dips).
- Disconnect road drainage features from watershed hydrology. Shorten ditch lengths to stream crossings by installing a ditch relief culvert or rolling dip before the watercourse (see Road BMP RD-1.11 Ditch Relief Culvert Installation).
- In addition to installing DRCs on either approach to the stream crossings, it is also advisable to consider installing ditch drains before curves, above and below through-cut road sections, and before and after steep sections of the road.
- Ditches should neither be discharged directly into the inlet of a stream crossing culvert, nor should DRCs discharge into a watercourse without first directing flow through an adequate filter strip.
- Culverts should be designed and installed at intervals along the road that are close enough to prevent erosion of the ditch and at the culvert outfall. They should be installed at locations where collected water and sediment is not discharged directly into watercourses (Table 2).
- DRCs should not be used on erosive slopes without a downspout (see Construction BMP SS-11 Slope Drain).
- In areas of high erosion and/or storm runoff, *minimum* ditch relief culvert sizes should be 18 inches in diameter, and never less than 12 inches in other areas.
- A 10% grade to the culvert will usually be self cleaning. The culvert grade should also be at least 2% greater than the ditch which feeds it. The culvert should be placed at a 30 degree skew to the ditch to improve inlet efficiency and prevent plugging and erosion at the inlet.



- Stream crossings culverts and DRCs should be installed at the gradient of the original ground slope, so it will emerge on the ground surface beyond the base of the fill. If not, either the fill below the culvert outlet should be armored with rock, or the culvert should be fitted with an anchored downspout to carry erosive flow past the base of the fill (Figure 2) (see Road BMP RD1.12 Stream Crossing Installation).
- Culverts should be covered by a minimum of 1 foot of compacted soil, or a depth of 30% of its diameter, whichever is greater.
- Inlet protection, such as rock armoring or drop structures, can be used to help minimize erosion.
- DRCs must be spaced frequently enough to carry ditch and road surface waters without creating erosive concentrated flows. See attached table for spacing guidelines.

Road grade %	Upslope approach (distance from up-road start of rolling dip to trough) (ft)	Reverse grade (distance from trough to crest) (ft)	Depth below average road grade at discharge end of trough (ft)	Depth below average road grade at upslope end of trough (ft)
<6	55	15-20	0.9	0.3
8	65	15-20	1.0	0.2
10	75	15-20	1.1	.01
12	85	20-25	1.2	.01
>12	100	20-25	1.3	.01

Table 1. Table of rolling dips dimensions. From CDFG (2006).

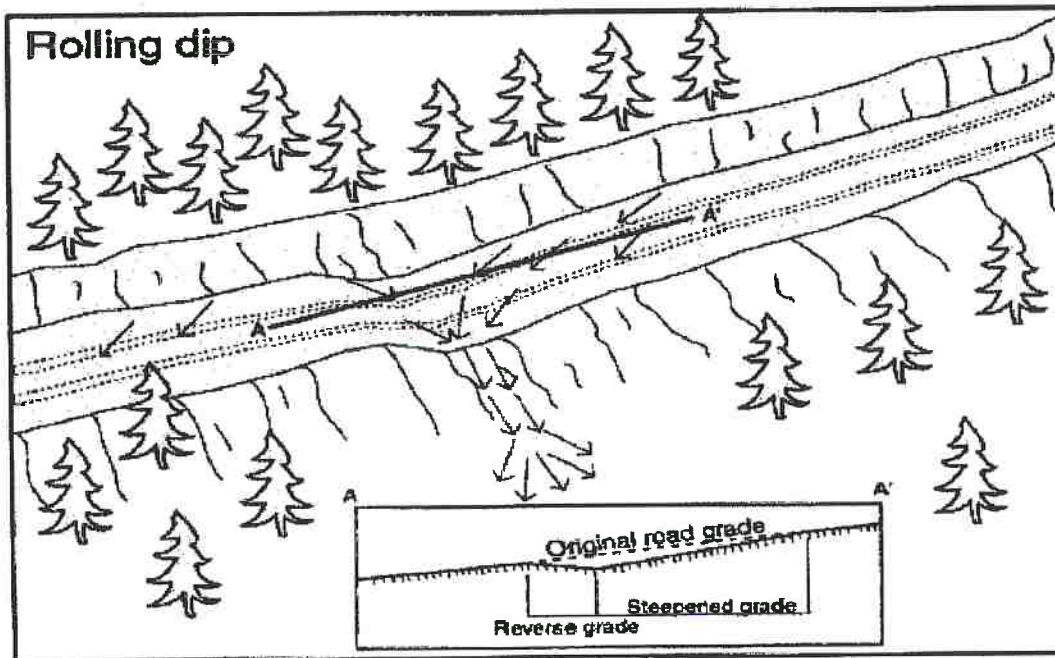

Figure 1. Use of rolling dips to reduce ditch erosion and surface runoff. Rolling dips must drain the road surface and be driveable for the expected traffic. From CDFG (2006).

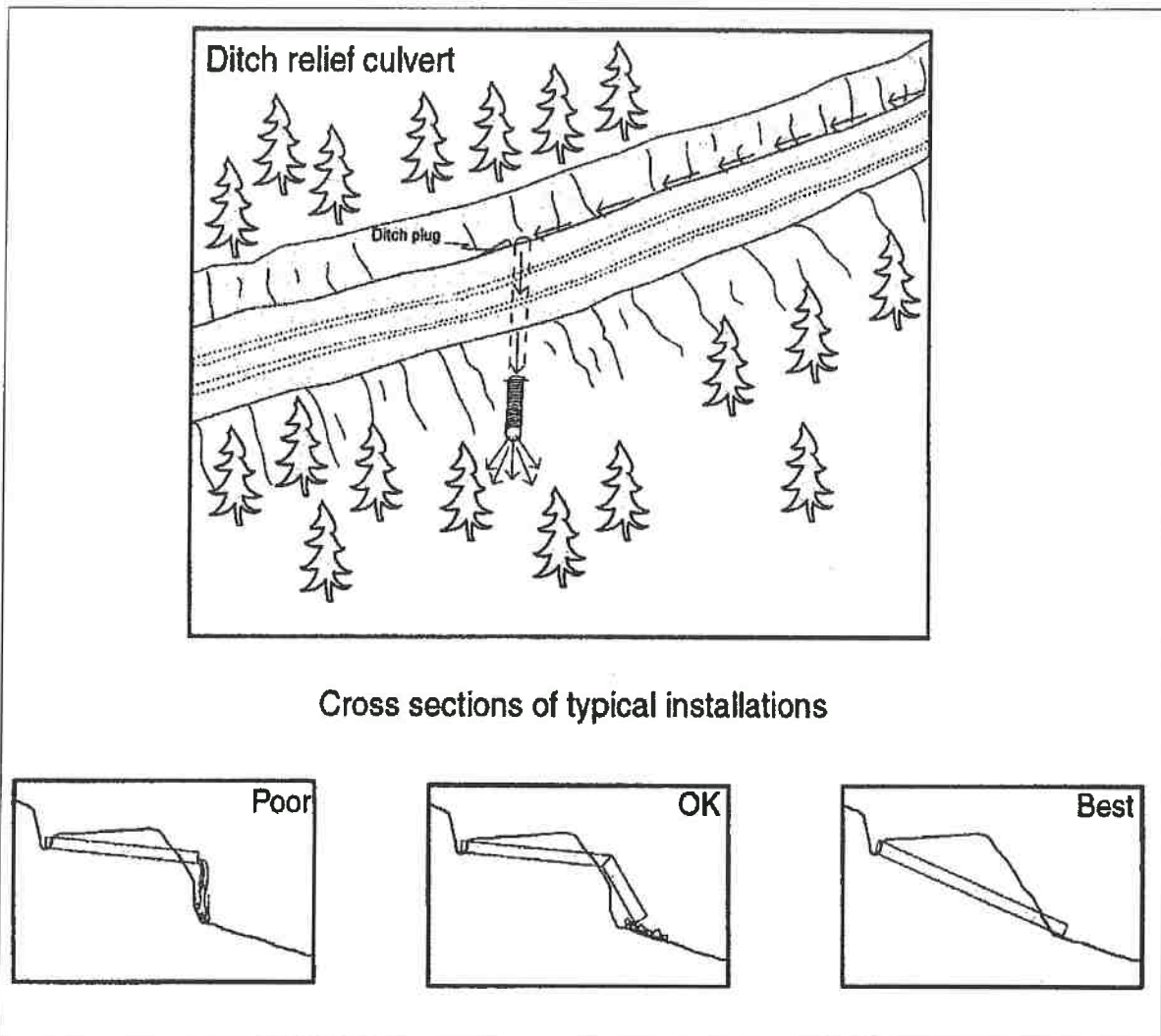

Figure 2. Typical ditch relief culvert installation. From CDFG (2002).

**Table 2. Maximum suggested spacing for ditch relief culverts<sup>1</sup> (ft)**

Road grade (%)	Soil credibility				
	very high	high	moderate	slight	very low
2	600-800 <sup>2</sup>				
4	530	600-800 <sup>2</sup>			
6	355	585	600-800 <sup>2</sup>		
8	265	425	525	600-800 <sup>2</sup>	
10	160	340	420	555	
12	180	285	350	460	600-800 <sup>2</sup>
14	155	245	300	365	560
16	135	215	270	345	490
18	118	190	240	310	435

<sup>1</sup>Adapted from Transportation Handbook USDA Forest Service, R-6, 1966. Culvert spacing may be too great in locations where ditch runoff is accumulated and discharged onto steep hillslopes that are prone to gullying. Spacing is designed to control ditch erosion, not culvert outfall erosion, and are based on 25-year storm and precipitation rate of 1-2 in/hr for 15 minutes. If less, multiply by the intensity 0.50, 0.30, etc. If 2-3 in/hr, divide distance in table by 1.50; if 3-4 in/hr, divide by 1.75; and if 4-5 in/hr, divide by 2.00. The U.S. Forest Service also publishes abundant information on preventing and controlling gully erosion below culvert outfalls. From Hagans and Weaver (1994).

<sup>2</sup>Even with stable ditches, ditch relief culvert spacing greater than about 600 to 800 feet is generally not recommended due to the large volume of road surface and cutslope runoff that would be discharged through the culvert and onto lower slopes during peak runoff periods. Culvert outlet erosion may occur with less than 800 feet of contributing ditch line, so observe local conditions to determine the upper limit of acceptable spacing in your area.

**Source Material for Road BMP RD-1.3 Road Drainage for Unpaved Road Surface**

2006. California Department of Fish and Game. Part X - Upslope Erosion Inventory and Sediment Control Guidance, California Salmonid Stream Habitat Restoration Manual.

1994. Weaver W.E. and D.K. Hagans. Handbook for Forest and Ranch Roads. Mendocino County Resource Conservation District

## **RD-1.14 ROAD SURFACE UPGRADE**

### **DESCRIPTION**

The road surface can be a big source of stream sediment. In some watersheds, it may be the primary source of accelerated (human-caused) erosion and sediment yield from the road system. Proper road construction and surfacing can significantly reduce this source of fine sediment. Permanent roads that are to be used for winter and wet weather hauling, including ranch roads and roads used for commercial hauling of forest products, need to be surfaced to improve trafficability and reduce erosion. Roads which receive heavy use should be inspected regularly to discover early signs of damage. Serious damage to road surfaces usually begins with the build up of thick (1-4 inch) accumulations of dry dust during the summer, or excess water (and mud) during the winter. Standing water is a sign of poor road drainage and ruts indicate that road strength is deteriorating.

### **BEST MANAGEMENT PRACTICES**

- Follow Road BMPS in RD-1.4 Road Surfacing.
- A stable and well drained subgrade is essential for a good road. The load bearing capacity of a road depends upon the subgrade's soil strength, drainage and compaction characteristics (Table 23). Native material is often suitable, and can be used for the road's subgrade. Weak or wet subgrades (soils unable to support a load by themselves) need to be strengthened by adding loose or crushed rock or gravel to provide ballast and distribute the stress placed on the soil.
- Wet, low strength soils may be stabilized by the use of synthetic fabrics (geotextiles) designed specifically for this application. The fabric is spread over the subgrade and then covered with a layer of rock. Water passes through the membrane, but the wet soil remains below and does not mix with the surface aggregate. As a result, the road dries faster and the fabric spreads the wheel loading pressures over a large surface area.
- The running surface of the road should be smooth and hard-wearing, and it should not be subject to blowing or washing away. The most commonly used surfacing materials are angular (crushed) rock. In the past, river-run gravel was frequently used where crushed rock was not readily available. However, rounded material is not as well suited as long lasting surfacing material and may be difficult to keep in-place.
- First, a "base course" of 2 to 3 inch diameter angular rock is usually dumped on the compacted native road surface using dump trucks, spread to a uniform depth using a grader or tractor and then compacted. The use of true compaction equipment (instead of tractors) will provide the best, longest lasting road surface. Geotextile engineering fabrics can be used beneath the base course material if soil conditions are wet. A finer "surface course" several inches in thickness is then spread over the compacted base course material to provide a dense, smooth running surface. The resulting layers of angular, interlocking rock will provide a low impact road surface that can be used during much of the winter (Table 24) (Figure 1).
- For all-weather use, angular rock should be placed to a total depth of 6-10 inches, or more, which will then compact to a finished depth of 4 to 6 inches under normal use. Table 24 lists the volume of aggregate needed to surface one mile of road, ranging from 10-20 feet wide, to a depth of 1-6 inches.

**Table 23. Soil characteristics for road subgrade materials<sup>1</sup>**

Material type	Strength, compaction and foundation suitability	Drainage	Reaction to frost	Common symbols of soil types <sup>2</sup>
Clean gravels and clean sand <sup>3</sup>	Good to excellent	Excellent	None to slight	GW, GP, SW, SP
Gravels and sands with non-plastic <sup>4</sup> fines	Good to excellent	Fair to poor	Slight to high	GMd, SMd
Gravels and sands with plastic <sup>4</sup> fines	Fair to good	Poor to impervious	Slight to high	GMu, GC, SMu, SC
Non-plastic and slightly plastic <sup>4</sup> silts and clays	Poor to fair	Fair to impervious (mostly poor)	Medium to high	ML, CL, OL
Medium and highly plastic <sup>4</sup> silts and clays	Very poor to poor	Poor to impervious (mostly poor)	Medium to very high	MH, CH
Peat and other highly organic soils	Very unstable, poor compaction	Fair to poor	Slight	Pt

<sup>1</sup> W.D.N.R. (1992)

<sup>2</sup> Unified Soil Classification System (USCS) symbol

<sup>3</sup> "Clean" means less than about 12% of the material is smaller than 1/64" (the smallest particle visible to the naked eye)

<sup>4</sup> Plasticity can be tested by simple field methods, including lightly wetting a hand sample, rolling the fines into a ball and then into a thread before it crumbles.

*Non-plastic: a thread cannot be formed, regardless of the moisture content. Low plasticity: after 2-3 times, the molded ball will crumble.*

*Medium plasticity: After 3-5 times, the ball will easily crumble with moderate force (pressed between thumb and forefinger).*

*High plasticity: ball will not crumble, even with moderate force, after five times.*

Table 23. From Weaver and Hagans (1994).

Figure 1. Cross section diagram showing typical base-course and surface-course application for forest and ranch roads (USDA\_SCS, 1983). From Weaver and Hagans (1994).

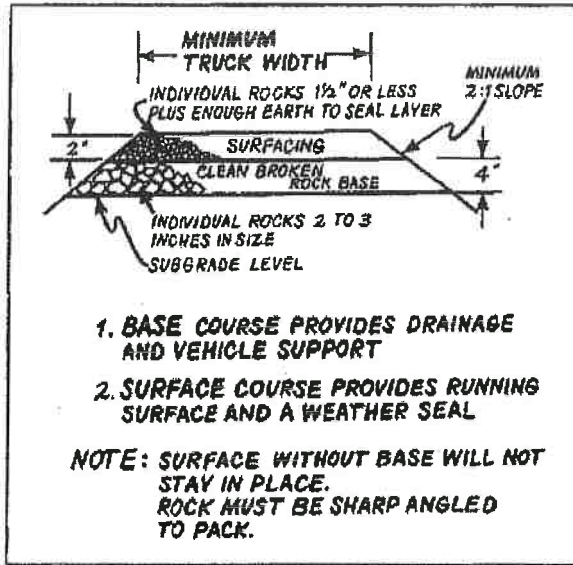

Table 24. Aggregate (yds<sup>3</sup>) required to one mile of road<sup>1</sup>

Road width (ft)	Depth of uncompacted rock (inches)					
	2"	4"	6"	8"	10"	12"
10'	326	652	978	1,304	1,630	1,956
12'	391	782	1,174	1,564	1,956	2,348
14'	456	913	1,369	1,826	2,282	2,738
16'	522	1,043	1,565	2,086	2,608	3,130
18'	587	1,174	1,760	2,348	2,934	3,520
20'	652	1,304	1,956	2,608	3,260	3,912

<sup>1</sup> USDA (1978). Uncompacted, 16.3 yds<sup>3</sup> equals 1 inch deep by 1 foot wide by 1 mile long. When aggregate is compacted, increase volumes required by 15-30%, depending on type and gradation of material.

From Weaver and Hagans (1994).

**Source Material for Road BMP RD-6.2 Road Surface Upgrade**

1994. Weaver W.E. and D.K. Hagans. Handbook for Forest and Ranch Roads. Mendocino County Resource Conservation District

## RD-1.15 ROUTING AND LOCATION

### DESCRIPTION

Roads should be plotted and located by a person with some knowledge of the area to be served by the road and of the terrain where the road is to be built. An engineer or geologist should be consulted in routing forest system roads to identify unstable terrain and to protect aquatic resources.

### LIMITATIONS

Road system layout is influenced by many factors, including topography, property lines, obstacles (rock outcrops, unstable areas, etc), and proposed land use activities. Controls on the location of a road include both natural features and man-made elements (Table 1).

Control	Comment
Legal	Boundary lines limit the location of a road. Talk with adjacent landowners and work out written right-of-way agreements to share roads and reduce road construction.
Specific Location	The beginning and ending points of a road are often fixed. These represent major controls.
Safety	Each class of road and level of use have specific safety requirements. Common sense should be applied in setting speed, grades, curve radius, sight distance, and turnouts.
Pollution Control	Roads should avoid problem areas. Allow ample room to trap sediment in a buffer before it reaches a stream. Do not allow any direct discharge points where road runoff flows directly into the stream. Avoid flood plains, landslides, credible soils, etc., as well as slopes over 40% wherever possible.
Design Elements	Physical limits for curve radius, road grade, pitch grade, stopping distance and separation from streams are set by you. Design to reduce maintenance costs and pollution potential.
Migrating Fish	Observe and maintain substantial buffers. Know what species use your streams, their habitat requirements, the susceptible periods of their life cycle, and their environmental tolerance limits. Permits may be needed from the Department of Fish and Game.
Approach Roads Permits	Issued by California Department of Transportation of the County for roads connecting to public highways. Location for intersections may be restricted.

*From Hagans and Weaver (1994). <sup>1</sup> Adapted from USD A-SCS (1981).*

### BEST MANAGEMENT PRACTICES

- Identify and map the following conditions on the ground during the road layout process (Table 10):
  - favorable topography (especially benches and low gradient areas for landings turnouts and spoil disposal)
  - control points (the beginning and ending points, saddles and other sites)
  - obstacles (especially unstable or erodible soils, large rock outcrops and wet areas)
  - stream channels (including their degree of incision)
  - inner gorge locations
  - areas of steep slopes
  - any other obvious hazards or controls

**Table 10. Some natural controls which affect road location<sup>1</sup>**

Control		Comment
Saddles		Major control for road location
Ridges		Major control and often a satisfactory road site.
Stream crossings		Major control. Seek locations with gentle side slopes and locations wide enough to accommodate the road. Good sites for bridges or culverts are needed. Evaluate for migratory fish where needed. Will need Fish and Game 1603 permit.
Benches		Often a good location for road junctions, switchbacks, landings, turnouts, etc.
Cliffs or rock outcrops		Cross above or below at a safe location. Rock which can be ripped is less costly to remove than hard rock needing blasting.
Slides		Major control. Avoid or cross at the safest point. Ask for professional geotechnical assistance.
Wetlands (logs, swamps, wet meadows)		Major control. Avoid where possible or cross quickly at best point. May need Fish and Game clearance.
Valley floor	wide	Low gradient, desirable road location if above the flood line. If crossing, cross and get out of floodplain quickly. Little excavation required. Fish and Game permit may be required.
	narrow	Poor location because of flooding, erosion and pollution potential and high costs to cross the stream if it meanders. Keep road above floodplain. Fish and Game 1603 permit may be required.
Slopes	>40%, but <60%	Avoid sidestepping and sliver fills (thin blankets of fill placed on steep slopes) in which large bare areas are exposed to erosion. This loose sediment may be difficult to control because of long buffers needed.
	≥60%	Construction in unstable areas should be avoided. Full bench road construction and embanking material may be needed where slopes remain steep alongside stream channels. Proceed only with extreme caution. Avoid road construction on these steep slopes if possible.
	ridge crest	Good alignment and little excavation. Good drainage. Few culverts required. Adverse grade encountered on uneven ridges. Spur roads will have an adverse grade.
Aspect		Maintenance requirements in moist climates can be minimized by placing roads on south-facing slopes to promote drying and snow melt. In dry climates, (the north-facing slopes have more vegetation and may have less erosion. Extremely wet or dry climate negates this effect.
Rock slope (dip)		Place roads on the hillside where rocks dip (slant) into the hillside, not parallel to or out of the hillside. Consult a geologist for other problems and advice.
Soils		Where possible, avoid road building on naturally erodible soils. Check soils maps for potential problems and ask extension agents or the SCS for advice. Frozen soils require special care; ask for assistance.

From Weaver and Hagans (1994). <sup>1</sup> Adapted from USDA-SCS (1981)

- Identify and evaluate nearby rock outcrops for potential rock aggregate for road surfacing materials.
- Identify broad ridge crests and benches as possible locations for landings, road turnouts and spoil disposal sites (Figure 1).
- Locate switchback with little or no grade so that trucks and equipment can pass safely and so they won't tear up the road surface while turning the corner and continuing up the road.



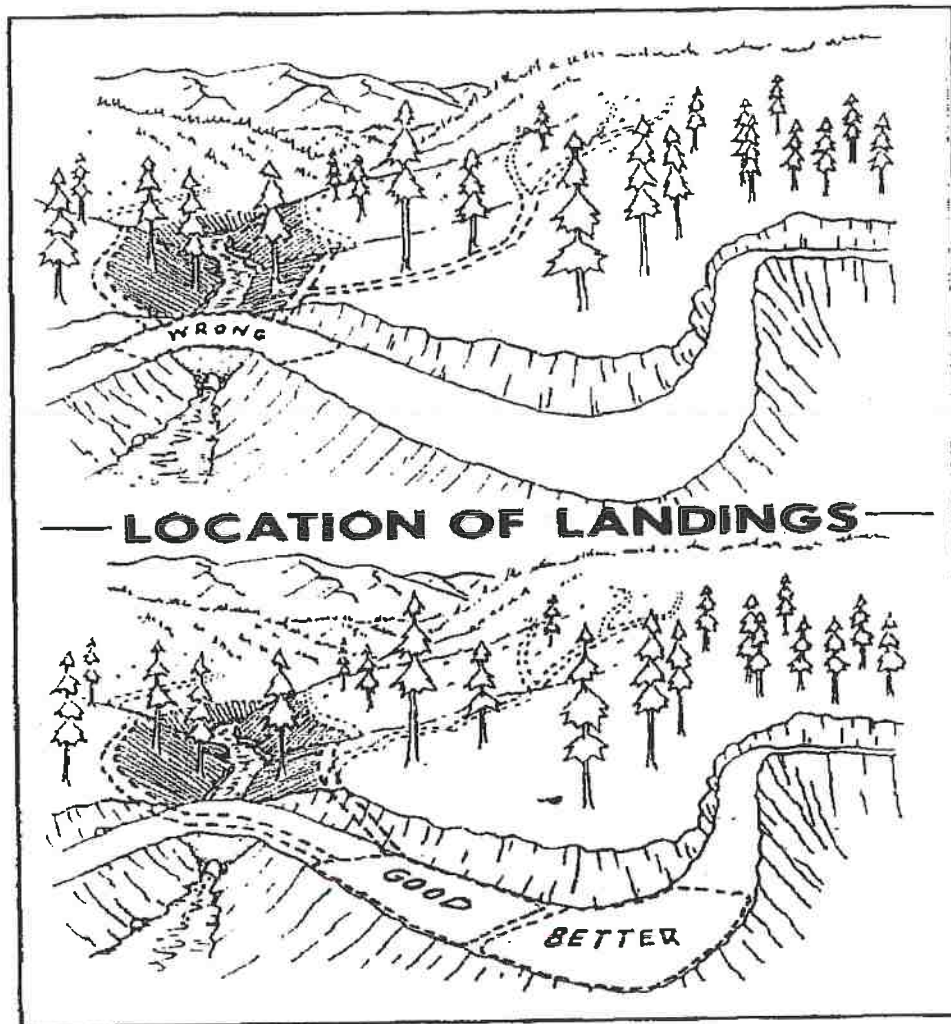

Figure 1.. Log landings on forest road systems should be kept to the absolute minimum size necessary to accommodate yarding, loading and hauling equipment and the minimum number needed to remove timber resources. Landings constructed on gentle ground and broad ridge crests far removed from stream channels are least likely to cause water quality problems, whereas landings built on steep slopes and near watercourses can result in severe impacts. From Weaver and Hagans (1994). Adapted from (USFS, 1963).

For more information, see Handbook for Forest and Ranch Roads. Weaver and Hagans (1994) and consult a trained engineer or geologist before construction. A trained wildlife biologist may be required to investigate for endangered species or species of special concern. An archaeologist may occasionally be needed to identify cultural sites that have to be avoided or mitigated before construction can begin.

**Source Material for Road BMP RD-1.2 Routing and Location**

1994. Weaver W.E. and D.K. Hagans. Handbook for Forest and Ranch Roads. Mendocino County Resource Conservation District

## **RD-1.16 UNDERSTANDING ROAD REMOVAL**

### **DESCRIPTION**

Approaches to removing roads may be divided into six categories: closure, abandonment, reclassification as trail, decommissioning, conversion to trail, and obliteration (Figure 1).

### **REMOVAL OPTIONS**

#### **Closure**

Some agencies close roads with gates, berms, or deep ditches (tank traps) as an approach to road removal (see Road BMP RD-7.3 Road Closure). On-the-ground surveys indicate that conventional closure devices are ineffective at stopping road use by people intent on accessing restricted areas. With an effective device that prohibits motorized access, however, closure may reduce a road's terrestrial impacts by providing wildlife security. Even so, closure is an ineffective approach to removing a road, because the road continues to disrupt natural drainage patterns, cause soil erosion, and potentially initiate mass failures; in short, a closed road continues to impact aquatic ecosystems.

#### **Abandonment**

When a road is "abandoned," it is no longer maintained and may or may not be driveable based on physical conditions or the presence of vegetation. The Forest Service considers road abandonment a "no-action treatment" (Moll 1996). Like a closed road with an effective closure device, abandoned roads that no longer receive motorized use may reduce a road's terrestrial impacts by providing wildlife security. Simply discontinuing maintenance and abandoning a road, however, rarely prevents continuing and potential hydrologic problems. The presence of vegetation may provide the false idea that the road is recovering and is no longer problematic. Culverts can become plugged, and roads may continue to function as surface flow paths for water. Road fills may remain unstable and susceptible to failure. Because an abandoned road continues to impact aquatic ecosystems, abandonment is an ineffective approach to removing a road.

#### **Reclassification as Trail**

Reclassifying a road as a trail without restoring drainage patterns and stabilizing fill materials is not an effective approach to removing a road, especially if motorized use continues. Even if wildlife security is improved by stopping motorized use, simply reclassifying a road as a trail does not address a road's aquatic impacts; this type of approach is basically the same as abandonment. If a road is changed to a trail, it must be actively converted (see "Conversion to trail" below) by first stabilizing fill materials and dispersing concentrated water.

#### **Decommissioning**

Decommissioning is carried out to minimize shortterm sediment production, while "storing" a road for future use. Major treatments include removing stream crossings and stabilizing sidecast fill material. Site-specific drainage treatments such as constructing cross road drains, removing inboard ditches, and/or outsloping also help disperse concentrated water. Road surfaces may be mechanically scarified to facilitate revegetation. The goal of decommissioning is to leave much of the road prism intact so the road can be reconstructed in the future with only minimal effort. Decommissioning preserves most of the original construction investment, while reducing road-caused erosion and avoiding maintenance and/or repair costs. Other common terms used to indicate road removal with plans for future reconstruction

include storm-proofing, flood-proofing, erosion-proofing, putting-to-bed, deactivation, reclamation, hydrologic closure, hydrologic obliteration, and storage for future use. Planning for reconstruction and leaving much of the road prism intact may result in treating a road too lightly during removal. Future plans may change; post-decommissioning is too late to further treat the road for the long-term. Even if decommissioning stops road-related erosion in the shortterm, it is not the same as obliterating a road because the road is expected to be reconstructed. Even if roads may be reconstructed in the future, they should be removed as if reconstruction will not occur.

**Conversion to Trail**

Converting a road to a modest walking trail can be an effective approach to removing a road if all fill materials are stabilized before the trail is constructed. Some road-to-trail conversions are implemented by only partially recontouring a road, which may not stabilize all fill materials. Conversion is ineffective when ORVs are allowed because impacts associated with motorized use continue. Though trails are less intrusive and damaging than roads, they can cause similar impacts, such as stream sedimentation and facilitation of non-native species invasions.

**Obliteration**

Obliteration involves removing a road with no plans for future reconstruction. To be most effective, obliteration restores the original landform to the greatest extent possible. Stream crossings are removed and slopes are recontoured. Road surfaces and fill sites are ripped to improve subsurface water flow. Coarse woody debris placed on the recontoured road surface provides erosion protection, long-term nutrient sources, and wildlife habitat. Revegetation is also actively carried out with native species collected near the site. Fully obliterating roads speeds the restoration and recovery of hydrologic function, as well as ecological and evolutionary processes. If implemented appropriately, obliteration is the most effective approach to road removal since it addresses both terrestrial and aquatic impacts caused by roads.

Road impact considerations	How different approaches to removing roads address road impact considerations					
	Close	Abandon	Reclassify as trail	Decommission	Convert to trail	Obliterate
Is wildlife security improved?	Yes* (short-term)	Yes (long-term)	Depends on extent of trail use	Yes* (short-term)	Depends on extent of trail use	Yes* (long-term)
Are fill stability problems fixed?	No	No	No	Yes* (short-term)	Yes*	Yes*
Is surface erosion controlled?	No	No	No	Yes* (short-term)	No* (much reduced)	Yes*
Will the road be reopened or reconstructed?	Yes	No	No	Yes	No	No
Is motorized use accommodated?***	Yes	Yes (unless overgrown)	Yes	No*	Yes	No*
Will continued maintenance and repair funding be necessary?	Yes	No	Yes	No* (until reconstructed)	Yes	No*
* if implemented effectively ** decommissioned and obliterated roads may continue to accommodate winter use by snowmobiles						

Figure 1. From Bagley (1998).

## **REMOVAL TREATMENT OPTIONS**

Specific road removal treatments include removing stream crossings, constructing cross road drains, ripping, recontouring, and outsloping. Each treatment is summarized below.

### **Stream Crossing**

Stream crossing removal is a fundamental treatment for removing roads. When done correctly, stream crossings are removed by excavating all fill materials and restoring the original channel and valley shape. Simply removing culverts is not enough, because any remaining road fill will erode into the channel. Materials excavated from stream crossings can be used to recontour road segments to their natural slope, essentially returning fill to the location from which it was cut. Endhauling is necessary when the amount of fill removed is greater than that needed for recontouring. Any road removal project that does not remove stream crossings (or does not remove all fill materials) is not effective and may cause more ecological damage by causing additional sedimentation.

### **Cross Road Drains**

Cross road drains are deep ditches excavated across road surfaces (similar to waterbars, but more substantial) to facilitate drainage on closed roads. They are too deep and steep to be cleared by motor vehicles. Unless spaced frequently enough to disperse concentrated water, cross road drains may cause erosion downslope. They must be constructed more frequently on roads with steep grades, but are not necessary if roads are fully recontoured or outsloped steeply.

### **Ripping**

Ripping involves decompacting road surfaces and fill sites to a depth of two to three feet. The goal is to enhance subsurface water flow by reducing soil density and increasing porosity, infiltration, and percolation. Ripping relatively impermeable fill sites reduces the chance of fill saturation and failure. Some soil settling occurs since organic matter is limited in sterile road soils. Therefore, adding organic matter to the ripped soil can greatly accelerate the recovery of hydrologic function, including both infiltration and percolation (Luce 1997). Ripping also increases revegetation success.

### **Recontouring**

Recontouring involves placing all fill materials back into locations where fill was removed during road construction. Recontouring restores the original slope as much as possible, dispersing concentrated water and greatly enhancing slope stability. Full recontouring is sometimes impossible, especially on very steep slopes, since the sidecast material may have slid downhill out of reach. In some cases, cutslopes will be so high and road cuts so narrow, that replaced fill material will not blend with the original undisturbed slope. Even so, slope recontouring to the extent possible generally results in the most stable landform shape, restores natural surface runoff patterns, and deters motorized access.

### **Outsloping**

Outsloping involves filling inboard ditches with sidecast fill material and sloping the road surface to disperse water to the downhill side of the road. Some sidecast fill materials remain, but saturation and potential failure is reduced because water cannot concentrate in inboard ditches or on the road surface. The remaining fill slope materials may still cause stability problems, especially on steep slopes.

**Source Material for Road BMP RD-7.2 Understanding Road Removal**

1983. Bagley, Scott. The Road-Ripper's Guide to Wildland Road Removal. Wildlands Center for Preventing Roads

1994. Weaver W.E. and D.K. Hagans. Handbook for Forest and Ranch Roads. Mendocino County Resource Conservation District

**RD-1.17 ROAD CLOSURE**

**DESCRIPTION**

Road closure is an effective tool in managing road systems to protect private property, road systems, water quality, and sensitive landscapes. Choosing the access control treatment depends on the type of vehicle access to be discouraged and the length of the closure (Table 1). For example, closure treatments can be designed to discourage motorized traffic, but allow mountain biking or walking access. Closure treatments can also be designed to permanently close a road or allow seasonal treatments. The closure treatment chosen should reflect both the short term and long term use of the road system.

**BEST MANAGEMENT PRACTICES**

<b>Closure Type</b>	<b>Description</b>	<b>Purpose Application</b>
Blockage with On-Site Materials	Rock, logs, stumps, slash piles, posts, water bars, tank traps, decomposition	Discourage use, economical, dependent on-site and available material
Vegetative Planting, Seeding	Trees, shrubs, cactus, and grass seeding, recycled paper mulch, chip and spread slash	Discourage use, camouflage road, speed revegetation and healing of site, provide browse and forage
Imported Material	Fences, gates, posts, guardrails, concrete barriers	Discourage use, lack of on-site material or inappropriate site for use of on-site materials
Pole Fences Wood Barriers	Onsite or imported poles, reinforce with metal strips to deter chain-sawing	Discourage use, can be dismantled for emergency access, aesthetically pleasing
Closure Devices	Materials used include metal telescoping tubing, pipe, and well casing. Available in single lane to double lane widths	Discourage use, allow quick easy access, single or multiple locks, signing
Obliteration	Re-contour road junction or entire road. Combine with other closure treatments. Removal of drainage structures, bridges, and associated embankments	Eliminate travelway, return corridor to resource production, reduce modifications to hydrology and aesthetics, camouflage road

*Table 1. Access Control Treatments. Adapted from US Forest Service 1996.*

**Source Material for Road BMP RD-7.3 Road Closure**

1996. US Forest Service. A Guide for Road Closure and Obliteration in the Forest Service. Technology and Development Program. Publication: 9677 1205.

# EC-1.1 JUTE MAT BLANKET

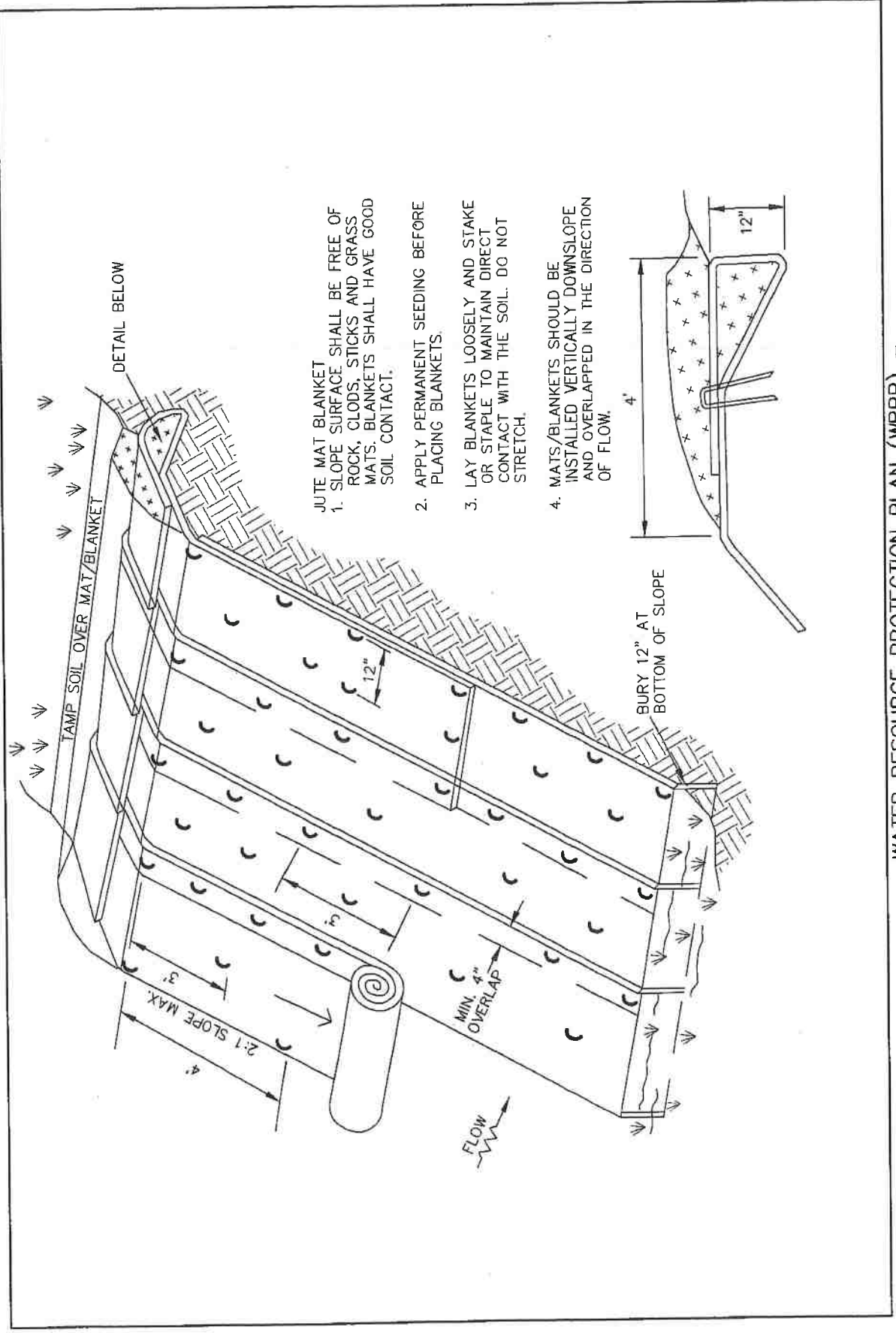

- JUTE MAT BLANKET**
1. SLOPE SURFACE SHALL BE FREE OF ROCK, CLODS, STICKS AND GRASS MATS. BLANKETS SHALL HAVE GOOD SOIL CONTACT.
  2. APPLY PERMANENT SEEDING BEFORE PLACING BLANKETS.
  3. LAY BLANKETS LOOSELY AND STAKE OR STAPLE TO MAINTAIN DIRECT CONTACT WITH THE SOIL. DO NOT STRETCH.
  4. MATS/BLANKETS SHOULD BE INSTALLED VERTICALLY DOWNSLOPE AND OVERLAPPED IN THE DIRECTION OF FLOW.

## EC-1.2 CULVERT OUTLET ENERGY DISSIPATER

### DESCRIPTION

An energy dissipater is a structure designed to control erosion at the outlet of a culvert or conduit by reducing the velocity of flow and dissipating the energy (see BMP SS-10 Outlet Protection/Velocity Dissipation Devices).

### LIMITATIONS

- Do not use this BMP below the mean high water line of any water body before obtaining appropriate permits. Due to issues relative to Corps 404 jurisdiction sometimes energy dissipaters are not placed below the ordinary high water mark which results in increased erosion.
- Consider other energy dissipaters such as concrete impact basins, paved outlet structures, or a half culvert where site conditions warrant.
- Rock/riprap dissipaters may require containment in mattresses to maintain their effectiveness.

### BEST MANAGEMENT PRACTICES

- Size rock to handle high velocity storm events.
- Key rock into sides of fillslope to prevent undercutting (Figure 1).
- Best results are obtained when sound, durable, angular rock is used (Figure 2).
- Inspect after each significant rain for erosion and/or disruption of the rock, and repair immediately.

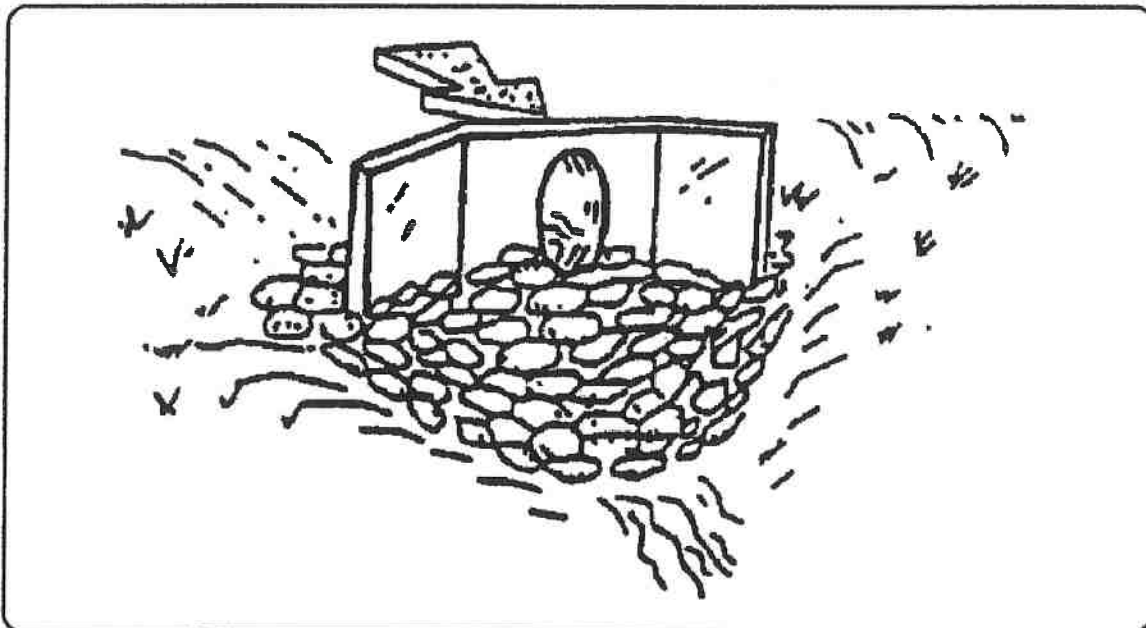

Figure 1. Flared outlet with rock energy dissipater. From Weber County, UT.



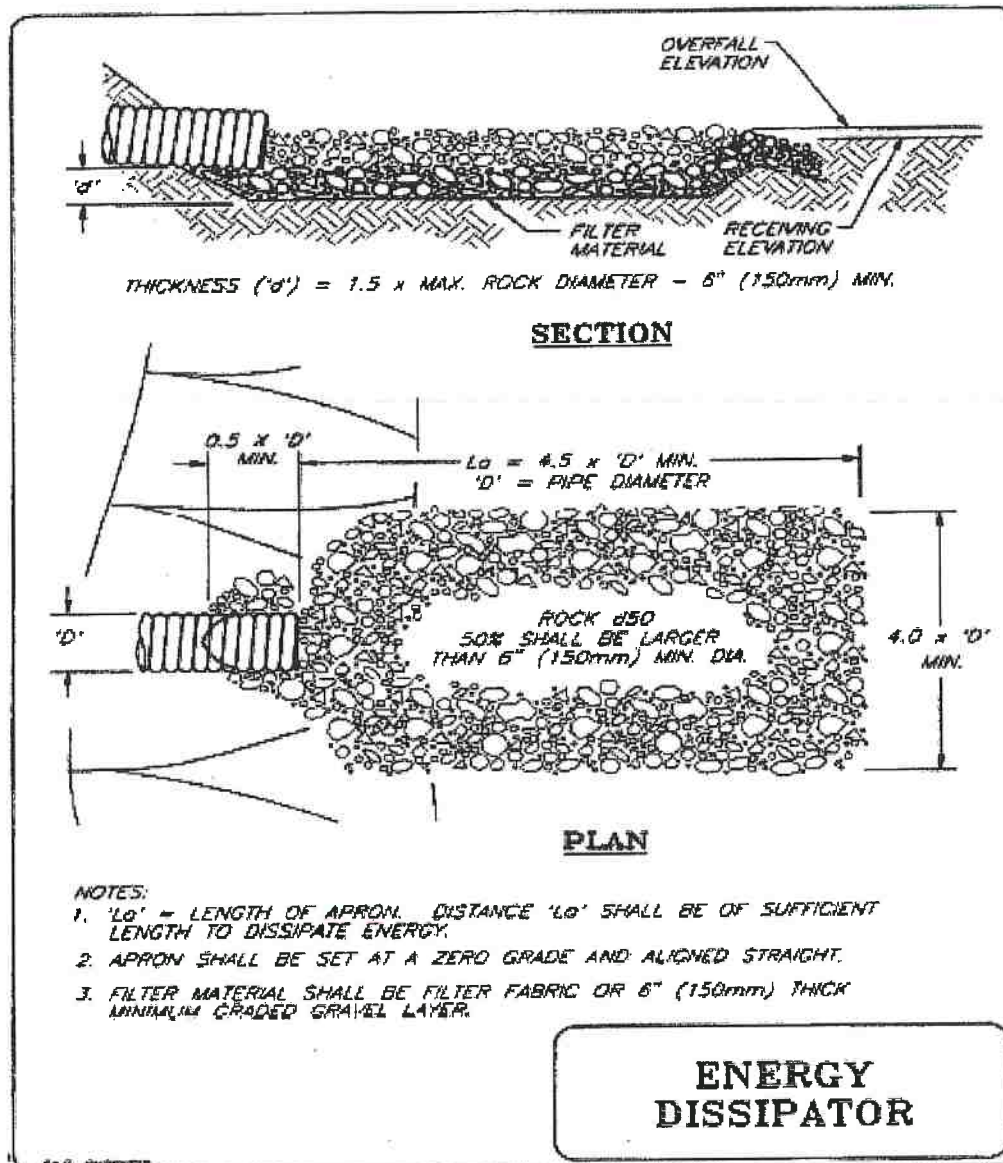

Figure 2. Rock energy dissipator. From 2004 Fishnet 4C. Adapted from 1994 McCullah.

**Source Material for Road BMP RD-2.12 Culvert Outlet Energy Dissipater**

2004. FishNet 4C. Guidelines for Protecting Aquatic Habitat and Salmon Fisheries for County Road Maintenance.

N/A. Weber County, Engineering Department. Ogden, Utah.

## **EC-1.3 OUTLET PROTECTION**

### **DESCRIPTION**

A rock outlet protection is a physical device composed of rock, riprap, grouted riprap, or concrete rubble which is placed at the outlet of a pipe to prevent scour of the soil caused by high pipe flow velocities, and to absorb flow energy to produce nonerosive velocities (see Construction BMP SS-10 Outlet Protection/ Velocity Dissipation Devices).

### **APPLICATIONS:**

- Wherever discharge velocities and energies at the outlets of culverts, conduits, or channels are sufficient to erode the next downstream reach.
- Rock outlet protection is best suited for temporary use during construction because it is usually less expensive and easier to install than concrete aprons or an energy dissipater (Figure 1) (see Erosion Control BMP EC-1.3 Energy Dissipater).
- A sediment trap below the pipe outlet is recommended if runoff is sediment laden (Figure 2).
- Permanent rock riprap protection should be designed and sized by the engineer as part of the culvert, conduit or channel design (Figure 2).
- Grouted riprap should be avoided in areas of freeze and thaw because the grout will break up.

### **LIMITATIONS**

- Large storms often wash away the rock outlet protection and leave the area susceptible to erosion.
- Sediment captured by the rock outlet protection may be difficult to remove without removing the rock.
- Outlet protection may negatively impact the channel habitat in streams.

### **BEST MANAGEMENT PRACTICES**

- Size rock to handle high velocity storm events (Figure 3).
- Key rock into sides of fillslope to prevent undercutting.
- Best results are obtained when sound, durable, angular rock is used.
- Inspect after each significant rain for erosion and/or disruption of the rock, and repair immediately.

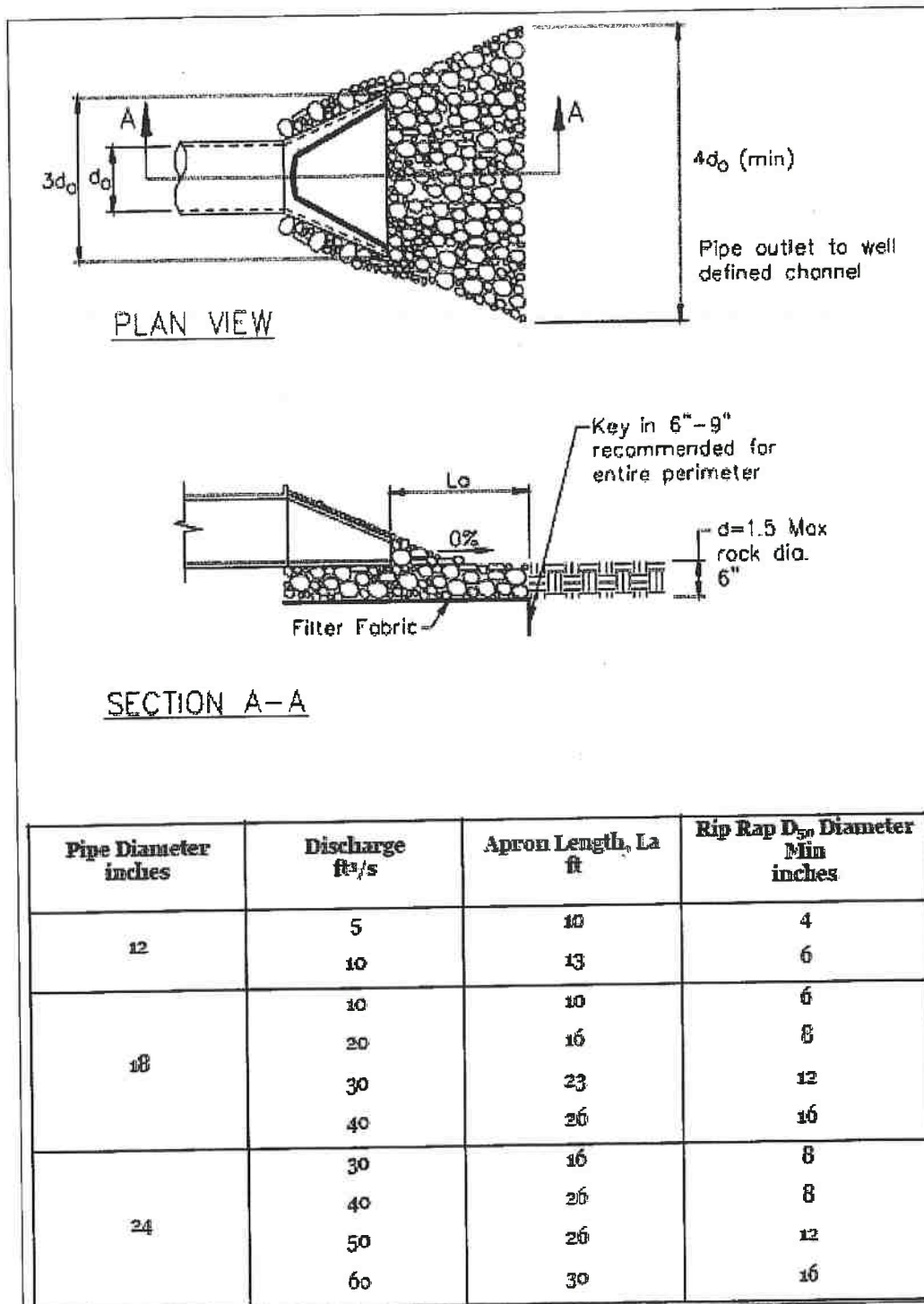

Figure 1. Flared outlet with energy dissipater. From Caltrans (2003). (Adapted from USDA-SCS).

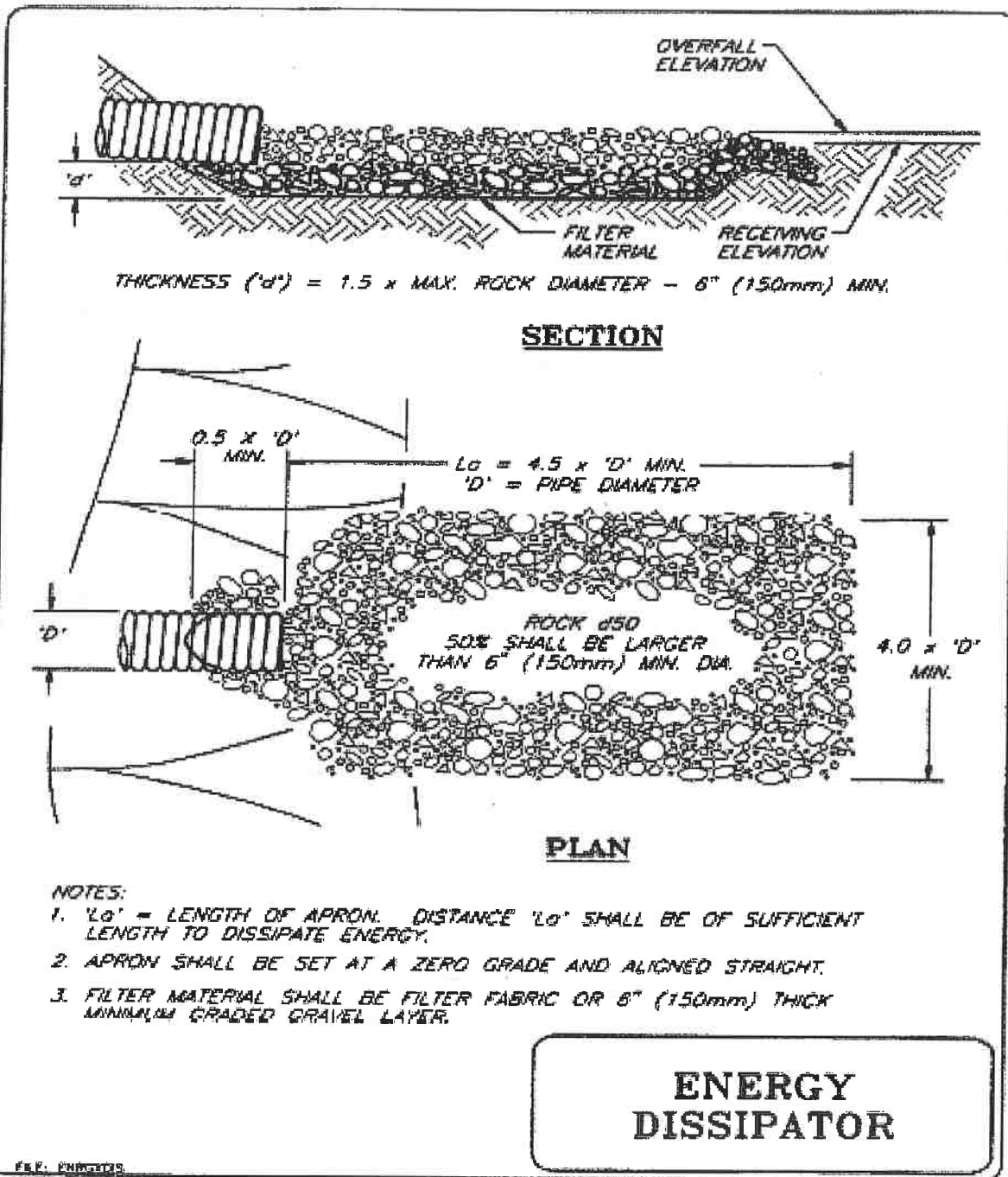

Figure 2. Rock energy dissipater. From 2004 Fishnet 4C. Adapted from 1994 McCullah.



Figure 3. Rock armoring on shotgun culvert outlet. Photo Courtesy of California Department of Transportation (Caltrans).

**Source Material for Road BMP RD-2.11 Outlet Protection**

2003. California Department of Transportation (CALTRANS). Storm Water Quality Handbooks – Construction Site Best Management Practices (BMPs) Manual.

2004. FishNet 4C. Guidelines for Protecting Aquatic Habitat and Salmon Fisheries for County Road Maintenance.

## **EC-1.4 STOCKPILE MANAGEMENT**

### **DESCRIPTION**

This activity involves the selection of sites in advance of the need for long-term and short-term stockpiling of materials for road maintenance activities and disposing of excess materials from excavations, grading and culvert basin cleaning. The general watershed criteria for selecting any disposal site is a site where the material will not erode into any part of the channel network, and where it will not initiate a formerly dormant landslide.

### **ENVIRONMENTAL CONCERNS**

- Filling wetlands with spoil material.
- Discharge of sediment, debris, or organic material into the stream or storm water discharge system.
- Destruction or harm to aquatic, riparian or wetland habitat, or to endangered or threatened plant and animal species due to placement of fill material.
- Surface or groundwater impacts from leachate formed in organic material disposal sites.
- Damage to endangered or threatened plant species on site.
- Slope stability of both the disposal site and the spoil pile.

### **BEST MANAGEMENT PRACTICES**

#### **Site Selection**

- Determine the location of existing disposal sites, potential disposal sites, and locations of significant spoil generation along roads.
  - Conduct site investigations of existing and potentially suitable disposal sites. Site investigations should include the disposal area size, distance to watercourses, potential slope instabilities, listed species habitat, archaeological sites, nearby residential areas, access, and other limiting factors.
  - Prepare a map and data set indicating sites (existing and potential) with acceptable site characteristics (see below). Prioritize acceptable sites.
  - Develop site plans for sites adjacent to or near riparian areas or streams to identify erosion and sediment control needs, and to ensure stability of the material.
- Follow these acceptable site characteristics in the site election & design process:
  - Seek a stable site where sediment cannot reach the stream during any high water event.
  - Avoid adjacent riparian corridors or any area within the 100-year floodplain.
  - Avoid all wetland sites as these sites are protected from disposal activities and permits will be required and may not be granted.
  - Avoid placing spoil on unstable slopes, where the added weight could trigger a land movement. Excessive loading of clay or silt soils could also trigger a failure.
  - Use wide, stable locations such as rock pits, ridges, and benches as places to dispose of fill. Avoid locations where ground water emerges or a thick organic layer is present. Do not leave loose soil piled in berms alongside the road or ditch.

- Avoid sites with endangered or threatened plant species. Search the California Natural Diversity Database ([www.dfg.ca.gov/whdab/html/cnddb.html](http://www.dfg.ca.gov/whdab/html/cnddb.html)) for any known listed plant sites in the area. Seek site evaluations by qualified botanists during the appropriate season before selecting a new site.

### **Implementation**

- Locate stockpiles a minimum of 50 ft away from concentrated flows of stormwater, drainage courses, and inlets.
- Protect all stockpiles from stormwater run-on using a temporary perimeter sediment barrier such as berms, dikes, fiber rolls, silt fences, gravel bags, or straw bale barriers.
- During the rainy season, soil stockpiles should be covered or protected with soil stabilization measures and a temporary perimeter sediment barrier at all times.
- During the non-rainy season, soil stockpiles should be covered or protected with a temporary perimeter sediment barrier prior to the onset of precipitation (Figure 1).
- Apply erosion and sediment control BMPs as needed.
- Place bagged materials on pallets and under cover.
- Implement wind erosion control practices as appropriate on all stockpiled material. For specific information.
- The performance of erosion control BMPs should be monitored routinely during construction, especially during and after storm events. BMPs should be maintained or upgraded as needed.
- Manage stockpiles of contaminated soil in accordance with State and Federal Regulations.
- Avoid sidecasting of soil in all cases where it could be delivered into a watercourse, riparian area, roadside ditch or storm drain. Do not sidecast outside of the landowner right-of-way without landowner's permission. In some instances, under the following guidelines (See Table 1), sidecasting is allowable given remote distances from spoils storage sites. In these cases, the setback distance required depends on slope and vegetation. The presence of vegetation helps to slow the travel of sediment downslope, so good judgment is needed to assess the situation. *Do not sidecast at all* if the slope is sparsely vegetated and it appears that sediment will travel with rain runoff into a stream or estuary system, even if setback distances are applied. On slopes of 5:1 (20% gradient) or less, sidecasting is allowed beyond 150 feet of a watercourse, stream crossing, riparian area, roadside ditch or storm drain. On 2:1 slopes (50%) or less, sidecasting is allowed beyond 300 feet of a watercourse, stream crossing, riparian area, roadside ditch or storm drain. On slopes greater than 2:1, typically sidecasting is *not recommended*, however there may be rare instances on slopes greater than 2:1 where sidecasting is acceptable given very long distances from waterbodies and good vegetative cover. Seek advice from local fisheries agency staff when in doubt. Avoid concentrating sidecasting repeatedly in the same place. Never sidecast large amounts of soil from major landslides.

SLOPE GRADIENT	DISTANCE FROM WATERCOURSE, STREAM CROSSING, RIPARIAN AREA, ROADSIDE DITCH, STORM DRAIN	SIDECASTING RULE
Any slope	Appears that sediment will travel with rainwater into watercourse.	Not allowed
5:1 ( 20%) or less	150 feet or more	Allowed using good judgment
2:1 (50%) or less	300 feet or more	Allowed using good judgment
Greater than 2:1 (50%)	Vegetated slope long distance from watercourse	Allowed
Greater than 2:1 (50%)	Sparsely vegetated slope and it appears that sediment will travel with rain into watercourse	Not allowed

Table 1. Sidecasting BMP. From FishNet 4C (2004).

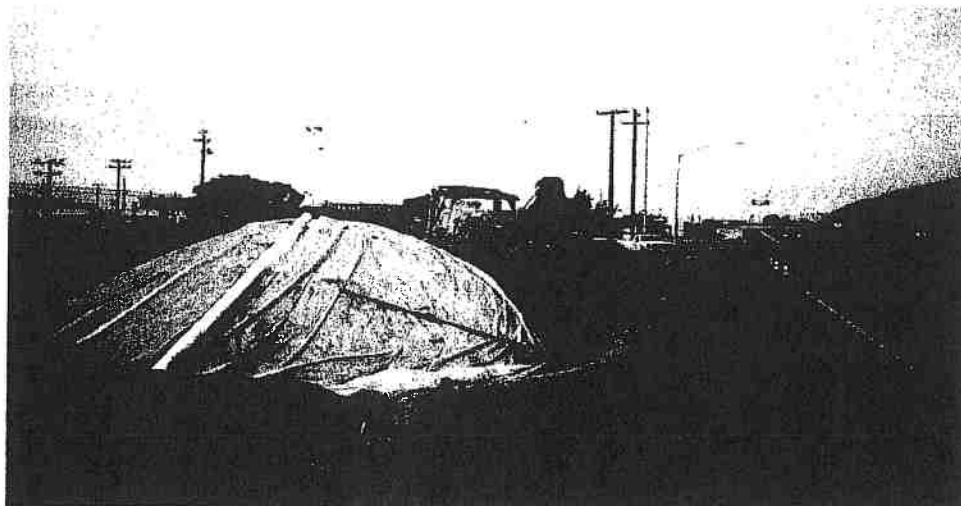

Figure 1. Stock piles should be covered with erosion and sediment control BMPs employed to keep sediment on site. From Caltrans (2003).

**Source Material for Road BMP RD-2.16 Stockpile Management**

2003. California Department of Transportation (CALTRANS). Storm Water Quality Handbooks – Construction Site Best Management Practices (BMPs) Manual.

2004. FishNet 4C. Guidelines for Protecting Aquatic Habitat and Salmon Fisheries for County Road Maintenance.



## Straw Mulch

**SS-6**

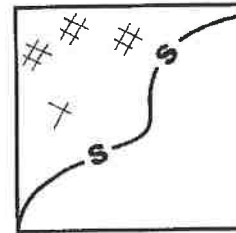
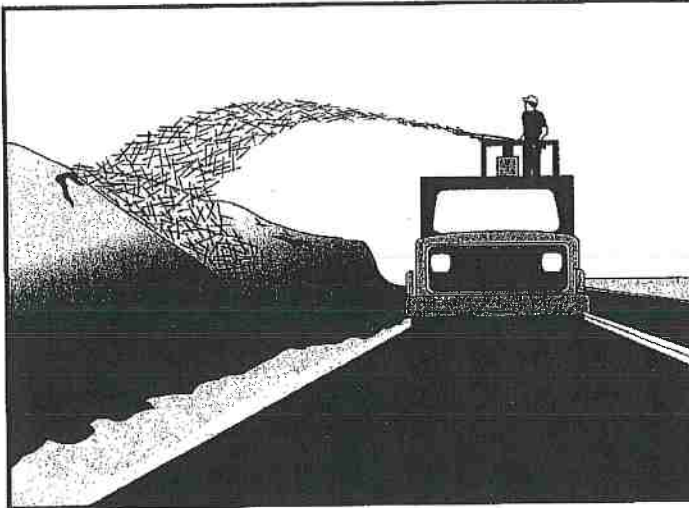

Standard Symbol

### BMP Objectives

- Soil Stabilization
- Sediment Control
- Tracking Control
- Wind Erosion Control
- Non-Storm Water Management
- Materials and Waste Management

**Definition and Purpose** Straw mulch consists of placing a uniform layer of straw and incorporating it into the soil with a studded roller or anchoring it with a stabilizing emulsion. This is one of five temporary soil stabilization alternatives to consider.

**Appropriate Applications**

- Straw mulch is typically used for soil stabilization as a temporary surface cover on disturbed areas until soils can be prepared for revegetation and permanent vegetation is established.

- Also typically used in combination with temporary and/or permanent seeding strategies to enhance plant establishment.

**Limitations**

- Availability of erosion control contractors and straw may be limited prior to the rainy season due to high demand.

- There is a potential for introduction of weed-seed and unwanted plant material.

- When straw blowers are used to apply straw mulch, the treatment areas must be within 45 m (150 ft) of a road or surface capable of supporting trucks.

- Straw mulch applied by hand is more time intensive and potentially costly.

- May have to be removed prior to permanent seeding or soil stabilization.

- “Punching” of straw does not work in sandy soils.

## Straw Mulch

SS-6

### Standards and Specifications

- Straw shall be derived from wheat, rice, or barley.
- All materials shall conform to Standard Specifications Sections 20-2.06, 20-2.07 and 20-2.11.
- A tackifier is the preferred method for anchoring straw mulch to the soil on slopes.
- Crimping, punch roller-type rollers, or track-walking may also be used to incorporate straw mulch into the soil on slopes. Track walking shall only be used where other methods are impractical.
- Avoid placing straw onto the traveled way, sidewalks, lined drainage channels, sound walls, and existing vegetation.
- Straw mulch with tackifier shall not be applied during or immediately before rainfall.

### Application Procedures

- Apply loose straw at a minimum rate of 3,570 kg/ha (4,000 lb/ac), or as indicated in the project's special provisions, either by machine or by hand distribution.
- If stabilizing emulsion will be used to anchor the straw mulch in lieu of incorporation, roughen embankment or fill areas by rolling with a crimping or punching-type roller or by track walking before placing the straw mulch. Track walking should only be used where rolling is impractical.
- The straw mulch must be evenly distributed on the soil surface.
- Anchor the mulch in place by using a tackifier or by "punching" it into the soil mechanically (incorporating).
- A tackifier acts to glue the straw fibers together and to the soil surface. The tackifier shall be selected based on longevity and ability to hold the fibers in place.
- A tackifier is typically applied at a rate of 140 kg/ha (125 lb/ac). In windy conditions, the rates are typically 200 kg/ha (178 lb/ac).
- Methods for holding the straw mulch in place depend upon the slope steepness, accessibility, soil conditions and longevity. If the selected method is incorporation of straw mulch into the soil, then do as follows:
  - Applying and incorporating straw shall follow the requirements in Standard Specifications Section 20-3.03.
  - On small areas, a spade or shovel can be used.

## Straw Mulch

**SS-6**

- On slopes with soils, which are stable enough and of sufficient gradient to safely support construction equipment without contributing to compaction and instability problems, straw can be “punched” into the ground using a knife-blade roller or a straight bladed coultter, known commercially as a “crimper.”
  - On small areas and/or steep slopes, straw can also be held in place using plastic netting or jute. The netting shall be held in place using 11 gauge wire staples, geotextile pins or wooden stakes. Refer to BMP SS-7, “Geotextiles, Plastic Covers and Erosion Control Blankets/Mats.”
- Maintenance and Inspections
- The key consideration in Maintenance and Inspection is that the straw needs to last long enough to achieve erosion control objectives.
  - Maintain an unbroken, temporary mulched ground cover while DSAs are non-active. Repair any damaged ground cover and re-mulch exposed areas.
  - Reapplication of straw mulch and tackifier may be required by the Resident Engineer (RE) to maintain effective soil stabilization over disturbed areas and slopes.
  - After any rainfall event, the Contractor is responsible for maintaining all slopes to prevent erosion.

### Source Material for Construction BMP SS-6

2003. State of California Department of Transportation. Caltrans Storm Water Quality Handbook Construction Site BMP Manual.

## Geotextiles, Mats, Plastic Covers and Erosion Control Blankets

**SS-7**

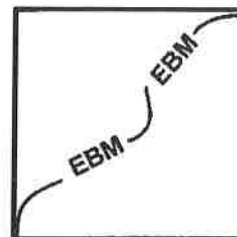
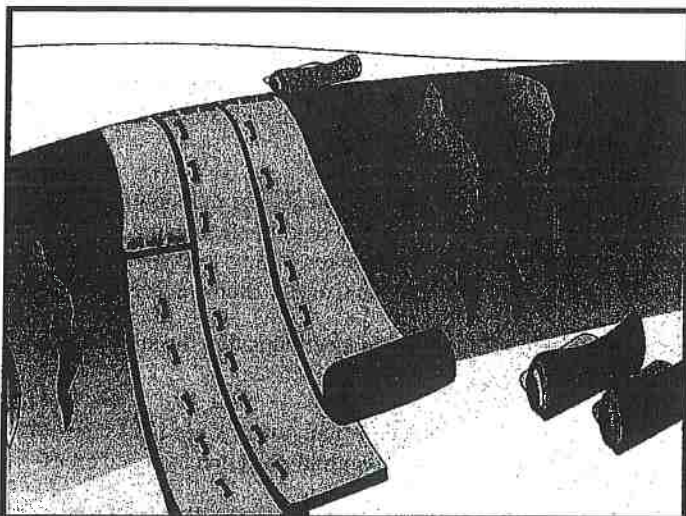

Standard Symbol

### BMP Objectives

- Soil Stabilization
- Sediment Control
- Tracking Control
- Wind Erosion Control
- Non-Storm Water Management
- Materials and Waste Management

**Definition and Purpose** This Best Management Practice (BMP) involves the placement of geotextiles, mats, plastic covers, or erosion control blankets to stabilize disturbed soil areas and protect soils from erosion by wind or water. This is one of five temporary soil stabilization alternatives to consider.

**Appropriate Applications** These measures are used when disturbed soils may be particularly difficult to stabilize, including the following situations:

- Steep slopes, generally steeper than 1:3 (V:H).
- Slopes where the erosion potential is high.
- Slopes and disturbed soils where mulch must be anchored.
- Disturbed areas where plants are slow to develop.
- Channels with flows exceeding 1.0 m/s (3.3 ft/s).
- Channels to be vegetated.
- Stockpiles.
- Slopes adjacent to water bodies of Environmentally Sensitive Areas (ESAs).

## **Geotextiles, Mats, Plastic Covers and Erosion Control Blankets**

**SS-7**

- Limitations**
- Blankets and mats are more expensive than other erosion control measures, due to labor and material costs. This usually limits their application to areas inaccessible to hydraulic equipment, or where other measures are not applicable, such as channels.
  - Blankets and mats are generally not suitable for excessively rocky sites, or areas where the final vegetation will be mowed (since staples and netting can catch in mowers).
  - Blankets and mats must be removed and disposed of prior to application of permanent soil stabilization measures.
  - Plastic sheeting is easily vandalized, easily torn, photodegradable, and must be disposed of at a landfill.
  - Plastic results in 100% runoff, which may cause serious erosion problems in the areas receiving the increased flow.
  - The use of plastic shall be limited to covering stockpiles, or very small graded areas for short periods of time (such as through one imminent storm event), until alternative measures, such as seeding and mulching, may be installed.
  - Geotextiles, mats, plastic covers, and erosion control covers have maximum flow rate limitations; consult the manufacturer for proper selection.

**Standards and  
Specifications**

### ***Material Selection***

There are many types of erosion control blankets and mats, and selection of the appropriate type shall be based on the specific type of application and site conditions. Selection(s) made by the Contractor must be approved by the Resident Engineer (RE); certification of compliance shall be in accordance with Standard Specifications Section 6-1.07.

### ***Site Preparation***

- Proper site preparation is essential to ensure complete contact of the blanket or matting with the soil.
- Grade and shape the area of installation.
- Remove all rocks, clods, vegetation or other obstructions so that the installed blankets or mats will have complete, direct contact with the soil.
- Prepare seedbed by loosening 50 mm (2 in) to 75 mm (3 in) of topsoil.

### ***Seeding***

Seed the area before blanket installation for erosion control and revegetation. Seeding after mat installation is often specified for turf reinforcement application. When seeding prior to blanket installation, all check slots and other areas disturbed during installation must be re-seeded. Where soil filling is specified, seed the matting and the entire disturbed area after installation and prior to filling the mat with soil.

## **Geotextiles, Mats, Plastic Covers and Erosion Control Blankets**

**SS-7**

**Maintenance and Inspection** Areas treated with temporary soil stabilization shall be inspected as specified in the special provisions. Areas treated with temporary soil stabilization shall be maintained to provide adequate erosion control. Temporary soil stabilization shall be reapplied or replaced on exposed soils when area becomes exposed or exhibits visible erosion.

- All blankets and mats shall be inspected periodically after installation.
- Installation shall be inspected after significant rain storms to check for erosion and undermining. Any failures shall be repaired immediately.
- If washout or breakage occurs, re-install the material after repairing the damage to the slope or channel.

### **Source Material for Construction BMP SS-7 Geotextiles, Mats, Plastic Covers and Erosion Control Blankets**

**2003. State of California Department of Transportation. Caltrans Storm Water Quality Handbook Construction Site BMP Manual.**

## Outlet Protection/Velocity Dissipation Devices

**SS-10**

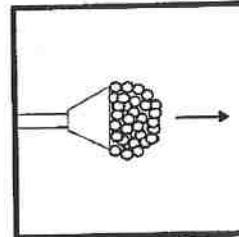
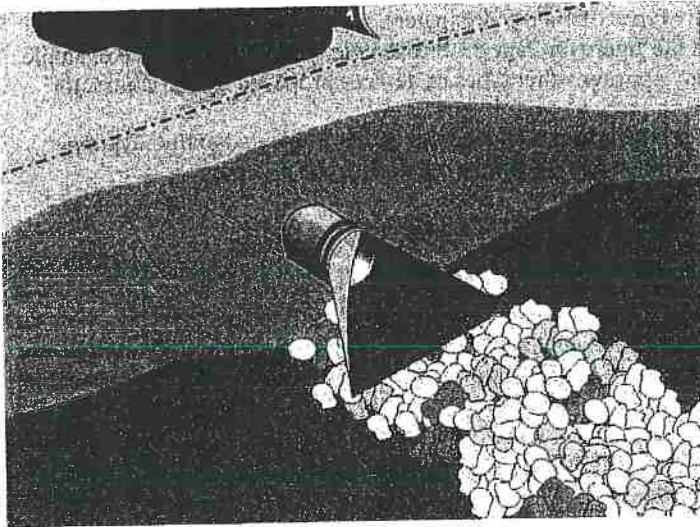

Standard Symbol

### BMP Objectives

- Soil Stabilization
- Sediment Control
- Tracking Control
- Wind Erosion Control
- Non-Storm Water Management
- Materials and Waste Management

**Definition and Purpose** These devices are placed at pipe outlets to prevent scour and reduce the velocity and/or energy of storm water flows.

### Appropriate Applications

- These devices may be used at the following locations:
  - Outlets of pipes, drains, culverts, slope drains, diversion ditches, swales, conduits or channels.
  - Outlets located at the bottom of mild to steep slopes.
  - Discharge outlets that carry continuous flows of water.
  - Outlets subject to short, intense flows of water, such as flash floods.
  - Points where lined conveyances discharge to unlined conveyances.
- This BMP may be implemented on a project-by-project basis with other BMPs when determined necessary and feasible by the Resident Engineer (RE).

### Limitations

- Loose rock may have stones washed away during high flows.
- Grouted riprap may break up in areas of freeze and thaw.
- If there is not adequate drainage, and water builds up behind grouted riprap, it may cause the grouted riprap to break up due to the resulting hydrostatic pressure.

## Outlet Protection/Velocity Dissipation Devices

---

**SS-10**

- Standards and Specifications**
- There are many types of energy dissipaters, with rock being the one that is represented in the figure on Page 3. Please note that this is only one example and the RE may approve other types of devices proposed by the contractor.
  - Install riprap, grouted riprap, or concrete apron at selected outlet. Riprap aprons are best suited for temporary use during construction.
  - Carefully place riprap to avoid damaging the filter fabric.
  - For proper operation of apron:
    - Align apron with receiving stream and keep straight throughout its length. If a curve is needed to fit site conditions, place it in upper section of apron.
    - If size of apron riprap is large, protect underlying filter fabric with a gravel blanket.
  - Outlets on slopes steeper than 10% shall have additional protection.
- Maintenance and Inspection**
- Inspect temporary measures prior to the rainy season, after rainfall events, and regularly (approximately once per week) during the rainy season.
  - Inspect apron for displacement of the riprap and/or damage to the underlying fabric. Repair fabric and replace riprap that has washed away.
  - Inspect for scour beneath the riprap and around the outlet. Repair damage to slopes or underlying filter fabric immediately.
  - Temporary devices shall be completely removed as soon as the surrounding drainage area has been stabilized, or at the completion of construction.



# Outlet Protection/Velocity Dissipation Devices

**SS-10**

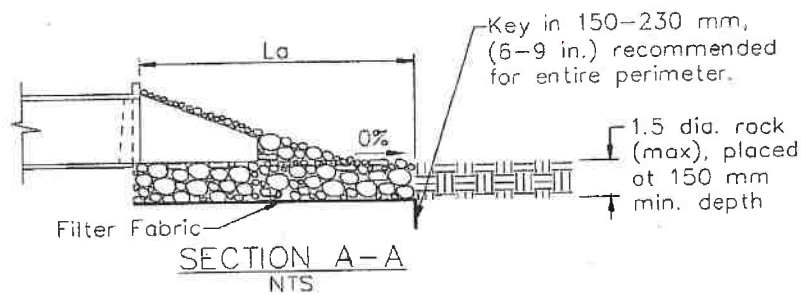
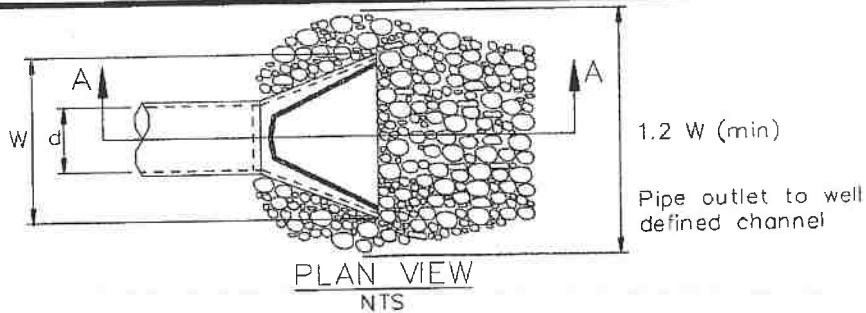

Pipe Diameter mm	Discharge m <sup>3</sup> /s	Apron Length, La m	Rip Rap D <sub>50</sub> Diameter Min mm
300	0.14	3	100
	0.28	4	150
450	0.28	3	150
	0.57	5	200
	0.85	7	300
	1.13	8	400
600	0.85	5	200
	1.13	8	200
	1.42	8	300
	1.70	9	400

For larger or higher flows, consult a Registered Civil Engineer

Source: USDA – SCS

### Source Material for Construction BMP SS-10 Outlet Protection

2003. State of California Department of Transportation. Caltrans Storm Water Quality Handbook Construction Site BMP Manual.

## Slope Drains

**SS-11**

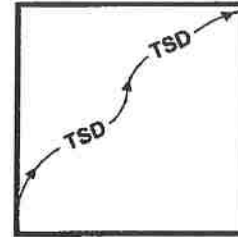
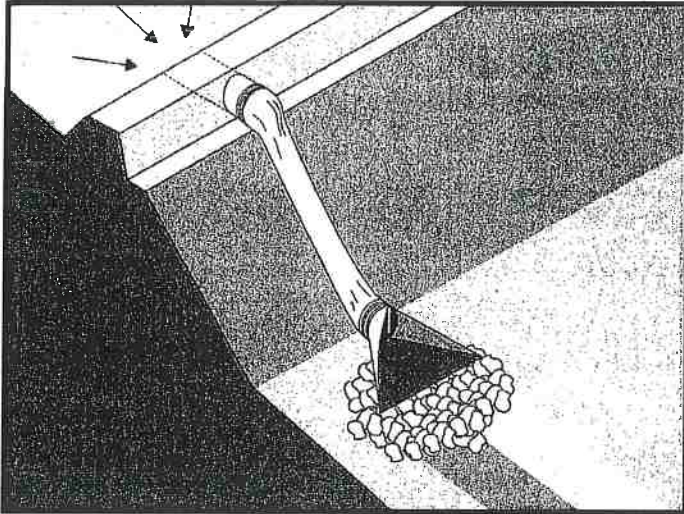

Standard Symbol

### BMP Objectives

- Soil Stabilization
- Sediment Control
- Tracking Control
- Wind Erosion Control
- Non-Storm Water Management
- Materials and Waste Management

<b>Definition and Purpose</b>	A slope drain is a pipe used to intercept and direct surface runoff or groundwater into a stabilized watercourse, trapping device or stabilized area. Slope drains are used with lined ditches to intercept and direct surface flow away from slope areas to protect cut or fill slopes.
<b>Appropriate Applications</b>	<ul style="list-style-type: none"> <li>■ Slope drains may be used on construction sites where slopes may be eroded by surface runoff.</li> <li>■ This BMP may be implemented on a project-by-project basis with other BMPs when determined necessary and feasible by the Resident Engineer (RE).</li> </ul>
<b>Limitations</b>	<ul style="list-style-type: none"> <li>■ Severe erosion may result when slope drains fail by overtopping, piping, or pipe separation.</li> </ul>
<b>Standards and Specifications</b>	<ul style="list-style-type: none"> <li>■ When using slope drains, limit drainage area to 4 ha (10 ac) per pipe. For larger areas, use a rock-lined channel or a series of pipes.</li> <li>■ Maximum slope generally limited to 1:2 (V:H), as energy dissipation below steeper slopes is difficult.</li> <li>■ Direct surface runoff to slope drains with interceptor dikes. See BMP SS-8, "Earth Dikes/Drainage Swales, and Lined Ditches."</li> <li>■ Slope drains can be placed on or buried underneath the slope surface.</li> <li>■ Recommended materials are PVC, ABS, or comparable pipe.</li> <li>■ When installing slope drains:                         <ul style="list-style-type: none"> <li>– Install slope drains perpendicular to slope contours.</li> </ul> </li> </ul>

## Slope Drains

**SS-11**

- Compact soil around and under entrance, outlet, and along length of pipe.
  - Securely anchor and stabilize pipe and appurtenances into soil.
  - Check to ensure that pipe connections are water tight.
  - Protect area around inlet with filter cloth. Protect outlet with riprap or other energy dissipation device. For high energy discharges, reinforce riprap with concrete or use reinforced concrete device.
  - Protect inlet and outlet of slope drains; use standard flared end section at entrance and exit for pipe slope drains 300 mm (12in) and larger.
- Maintenance and Inspection
- Inspect before and after each rain storm, and twice monthly until the tributary drainage area has been stabilized. Follow routine inspection procedures for inlets thereafter.
  - Inspect outlet for erosion and downstream scour. If eroded, repair damage and install additional energy dissipation measures. If downstream scour is occurring, it may be necessary to reduce flows being discharged into the channel unless other preventative measures are implemented.
  - Inspect slope drainage for accumulations of debris and sediment.
  - Remove built-up sediment from entrances, outlets, and within drains as required.
  - Make sure water is not ponding onto inappropriate areas (e.g., active traffic lanes, material storage areas, etc.).

## Slope Drains

**SS-11**

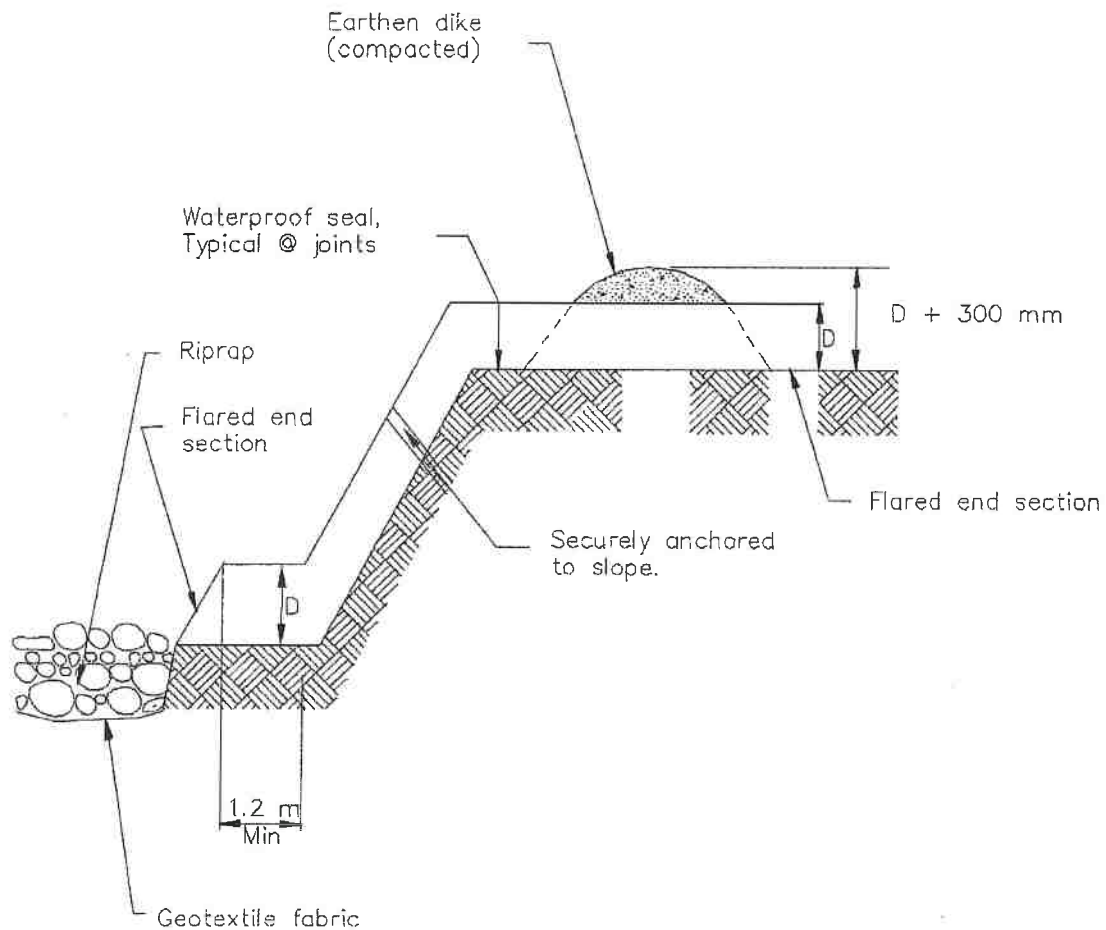

TYPICAL SLOPE DRAIN  
NOT TO SCALE

### **Source Material for Construction BMP SS-11 Slope Drains**

2003. State of California Department of Transportation. Caltrans Storm Water Quality Handbook Construction Site BMP Manual.

# SC-1.1 CHECK DAMS

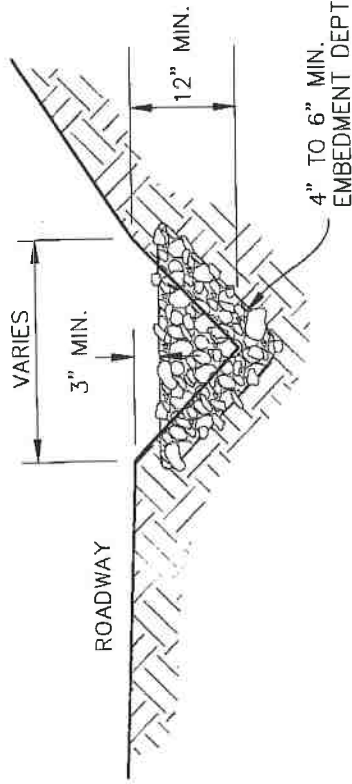

**SECTION VIEW**

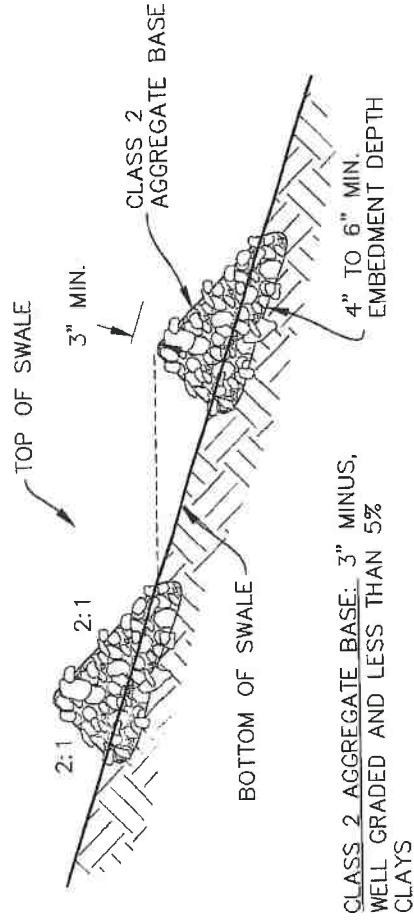

CLASS 2 AGGREGATE BASE: 3" MINUS,  
WELL GRADED AND LESS THAN 5%  
CLAYS

**CHCECK DAM SPACING**

- CHECK DAMS:**
1. CHECK DAMS SHALL BE INSTALLED AT ALL LOCATIONS INDICATED ON THE WRPP, AND AT ANY OTHER LOCATION DEEMED NECESSARY BY THE SITE CONTRACTOR.
  2. CHECK DAMS SHOULD BE SPACED SO THAT THE TOE OF CHECK DAM IS THE SAME ELEVATION AS THE TOP OF THE CHECK DAM BELOW.
  3. CHECK DAMS SHOULD BE IMBEDDED IN CHANNEL A MINIMUM OF 4"-6"
  4. CHECK DAMS THAT EXCEED A HEIGHT OF 3' SHOULD BE DESIGNED BY A QUALIFIED ENGINEER, GEOLOGIST, OR EROSION CONTROL SPECIALIST.
  5. CHECK DAMS SHALL BE INSPECTED PERIODICALLY THROUGHOUT THE COURSE OF CONSTRUCTION, ONCE AFTER EACH RAINFALL EVENT, AND ONCE EVERY 24 HOURS DURING EXTENDED RAINFALL EVENTS. ANY SPLIT, TORN, UNRAVELED OR SLUMPING FIBER ROLLS SHALL BE REPAIRED OR REPLACED IMMEDIATELY.

# SC1.2 TEMPORARY SEDIMENT BASIN

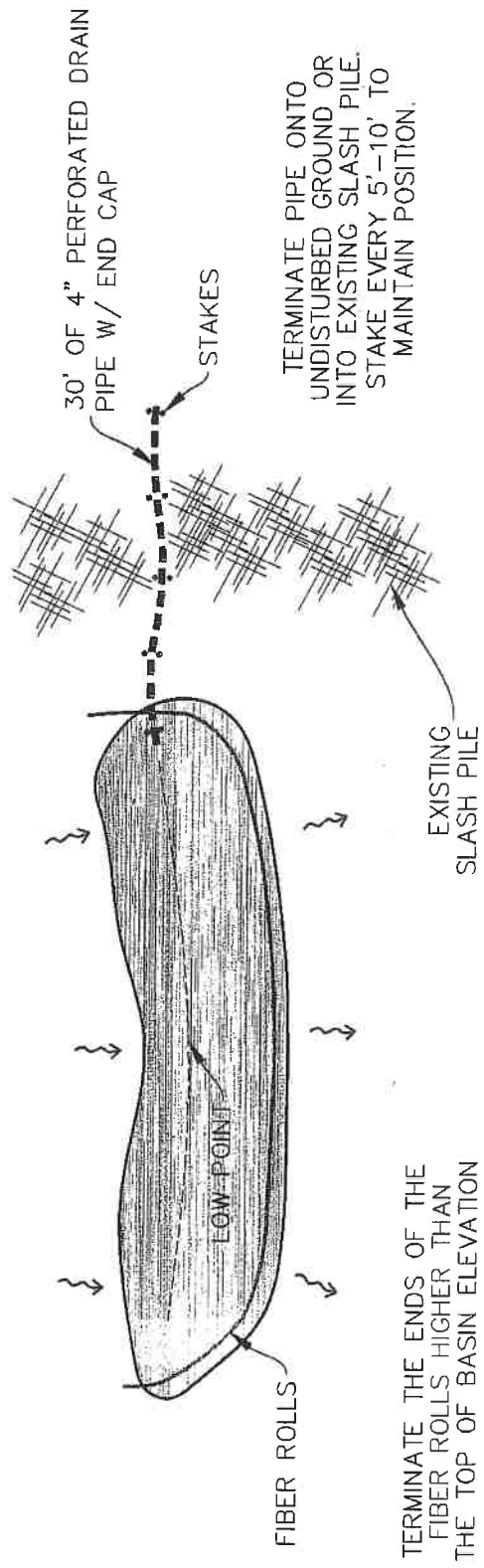

# SC-1.3 FIBER ROLLS

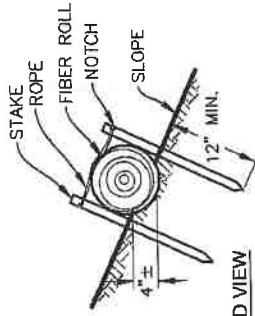

ENLARGED VIEW

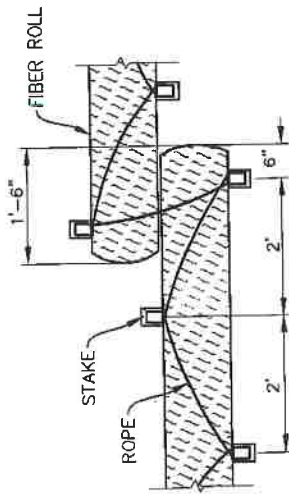
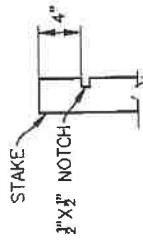

PLAN VIEW

- FIBER ROLLS:**
- FIBER ROLLS SHALL BE INSTALLED AT ALL LOCATIONS INDICATED ON THE WRPP, AND AT ANY OTHER LOCATION DEEMED NECESSARY BY THE SITE CONTRACTOR.
  - FIBER ROLLS SHOULD BE USED ALONG THE FACE OF EXPOSED SLOPES TO SHORTEN SLOPE LENGTH AND DECREASE FLOW VELOCITY; AT GRADE BREAKS WHERE SLOPES TRANSITION TO STEEPER SLOPES; AND ALONG STREAM BANKS TO ASSIST STABILIZATION, AND IN DRAINAGE SWALES TO SLOW FLOWS. ON 1:1 SLOPES PLACE FIBER ROLLS SPACED AT 10' INTERVALS PARALLEL TO SLOPE, ON 1.5:1 SLOPES PLACE FIBER ROLLS SPACED AT 15' INTERVALS PARALLEL TO SLOPE, AND ON 2:1 SLOPES PLACE FIBER ROLLS SPACED AT 20' INTERVALS PARALLEL TO SLOPE.
  - FIBER ROLLS SHALL CONSIST OF BIODEGRADABLE FIBERS STUFFED INTO A PHOTO-DEGRADABLE OPEN WEAVE NETTING. THEY SHALL BE DESIGNED TO ALLOW WATER TO PASS THROUGH THE FIBERS; TO TRAP SUSPENDED SEDIMENT; INCREASE FILTRATION RATES; AND TO SLOW RUNOFF.
  - FIBER ROLLS SHALL BE PLACED SUCH THAT THEY OVERLAP AND FOLLOW THE CONTOUR LINES OF THE SLOPE ON WHICH THEY ARE PLACED.
  - FIBER ROLLS SHALL BE INSPECTED PERIODICALLY THROUGHOUT THE COURSE OF CONSTRUCTION, ONCE AFTER EACH RAINFALL EVENT, AND ONCE EVERY 24 HOURS DURING EXTENDED RAINFALL EVENTS. ANY SPLIT, TORN, UNRAVELED OR SLUMPING FIBER ROLLS SHALL BE REPAIRED OR REPLACED IMMEDIATELY.

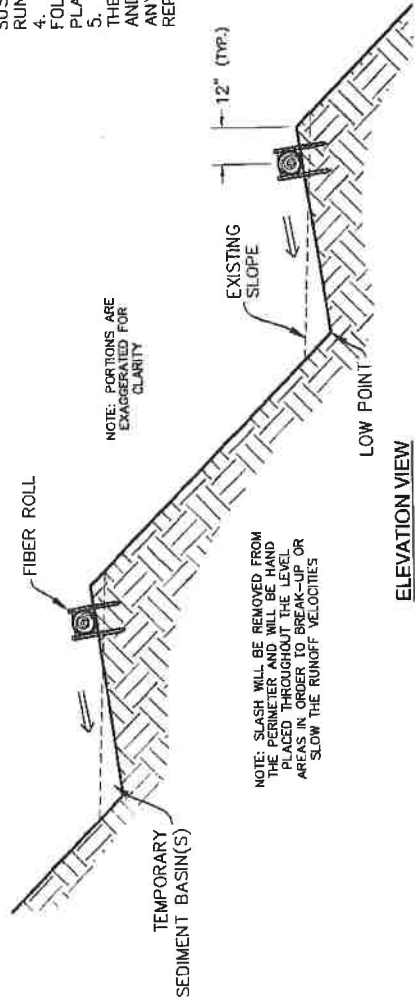

ELEVATION VIEW

## **ROAD BMP RESOURCES**

### **DESCRIPTION**

Listed below are some of the resource materials for Road BMPs that are available for landowners.

**2006. California Department of Fish and Game. Part X - Upslope Erosion Inventory and Sediment Control Guidance, California Salmonid Stream Habitat Restoration Manual.**

Available at:

California Department of Fish and Game  
Inland Fisheries Division  
ATTN: Salmonid Habitat Restoration Coordinator  
1416 Ninth Street, Sacramento, CA 95814 (916) 654-5997  
or  
[www.dfg.ca.gov/fish/resources/habitatmanual.asp](http://www.dfg.ca.gov/fish/resources/habitatmanual.asp)

**2003. California Department of Transportation (CALTRANS). Storm Water Quality Handbooks – Construction Site Best Management Practices (BMPs) Manual.**

Available at:

[www.dot.ca.gov/hq/construc/stormwater/CSBMPPM\\_303\\_Final.pdf](http://www.dot.ca.gov/hq/construc/stormwater/CSBMPPM_303_Final.pdf)

**2009. California Stormwater Quality Association (CASQA). California Stormwater BMP Handbook.**

Available at:

California Stormwater Quality Association  
PO Box 2105  
Menlo Park, CA 94026  
or  
[www.cabmphandbooks.com](http://www.cabmphandbooks.com)

**2004. FishNet 4C. Guidelines for Protecting Aquatic Habitat and Salmon Fisheries for County Road Maintenance.**

Available at:

3820 Cypress Dr., Suite 11  
Petaluma, CA 94954 Phone: 707.762.1336  
or  
[http://fishnet.marin.org/projects\\_roads\\_manual.html](http://fishnet.marin.org/projects_roads_manual.html)



**2002. Five Counties Salmon Conservation Program. A Water Quality and Stream Habitat Protection Manual for County Road Maintenance.**

Available at:

[www.5counties.org/Projects/FinalGeneralProjectPages/RoadsManual800.htm](http://www.5counties.org/Projects/FinalGeneralProjectPages/RoadsManual800.htm)

**1996. US Forest Service. A Guide for Road Closure and Obliteration In the Forest Service. Technology and Development Program. Publication: 9677 1205.**

Available at:

[www.fs.fed.us/eng/pubs/pdfimage/96771205.pdf](http://www.fs.fed.us/eng/pubs/pdfimage/96771205.pdf)

**2014. Weaver W.E., Wepner E. and Hagans D.K. Handbook for Forest, Ranch, and Rural Roads. Mendocino County Resource Conservation District.**

Available at:

Mendocino County Resource Conservation District  
404 Orchard Avenue, Ukiah, CA 95482 (707) 468-9223

Or

[http://mcrd.org/wp-content/uploads/Handbook\\_for\\_Forest\\_Ranch&Rural\\_Roads.pdf](http://mcrd.org/wp-content/uploads/Handbook_for_Forest_Ranch&Rural_Roads.pdf)





# Appendix E: References

*New Earth Farms, LLC. – Willow Creek  
Site Management Plan  
NorthPoint Consulting*

## Appendix E: References

1. Humboldt County Web GIS. (2018, May). Humboldt County Planning and Building Department. Retrieved from <http://webgis.co.humboldt.ca.us/HCEGIS2.0/>
2. State of California, Department of Forestry and Fire Protection. (2018, January). *California Forest Practice Rules: Title 14, California code of regulations, chapters 4, 4.5 and 10 with the Z'Berg Nejedley Forest Practice Act, the Professional Foresters law, and the Registration of Professional Foresters Rules*. Sacramento, CA: The California Department of Forestry and Fire Protection.
3. California Natural Diversity Database (CNDDDB) Maps and Data. (2018). California Department of Fish and Wildlife. Retrieved from <https://www.wildlife.ca.gov/Data/CNDDDB/Maps-and-Data#43018408-cnddb-in-bios>
4. State of California, North Coast Regional Water Quality Control Board. (2015, August). *Order No. R1-2015-0023: Waiver of Waste Discharge Requirements and General Water Quality Certification*. Retrieved from [https://www.waterboards.ca.gov/northcoast/board\\_decisions/adopted\\_orders/pdf/2015/15\\_0023\\_Cannabis\\_Order.pdf](https://www.waterboards.ca.gov/northcoast/board_decisions/adopted_orders/pdf/2015/15_0023_Cannabis_Order.pdf)
5. State of California, State Water Resources Control Board. (2017, October). *Cannabis Cultivation Policy: Principles and Guidelines for Cannabis Cultivation*. Retrieved from [https://www.waterboards.ca.gov/board\\_decisions/adopted\\_orders/resolutions/2017/final\\_cannabis\\_policy\\_with\\_att\\_a.pdf](https://www.waterboards.ca.gov/board_decisions/adopted_orders/resolutions/2017/final_cannabis_policy_with_att_a.pdf)
6. State of California, State Water Resources Control Board. (2017, October). *Order No. WQ 2017-0023-DWQ: General Waste Discharge Requirements and Waiver of Waste Discharge Requirements for Discharges of Waste Associated with Cannabis Cultivation Activities*. Retrieved from [https://www.waterboards.ca.gov/water\\_issues/programs/cannabis/docs/finaladoptedcango101717.pdf](https://www.waterboards.ca.gov/water_issues/programs/cannabis/docs/finaladoptedcango101717.pdf)
7. State of California, California Department of Transportation, Division of Environmental Analysis, Stormwater Program. (2017, May). CTSW-RT-17-314.18.1: *Construction Site Best Management Practices (BMP) Manual*. Retrieved from <http://www.dot.ca.gov/hq/construc/stormwater/CSBMP-May-2017-Final.pdf>
8. Weaver, W.E., Weppner, E.M. and Hagans, D.K. (2015, April). *Handbook for Forest, Ranch and Rural Roads: A Guide for Planning, Designing, Constructing, Reconstructing, Upgrading, Maintaining and Closing Wildland Roads*. Ukiah, California: Mendocino County Conservation Resource District.
9. Cafferata, P., Lindsay, D., Spittler, T., Wopat, M., Bundros, G., Flanagan, S., Coe, D., Short, W. (2017, August). *Designing Watercourse Crossings for Passage of 100-Year Flood Flows, Wood and Sediment (Updated 2017)*. Retrieved from [http://calfire.ca.gov/resource\\_mgt/downloads/100%20yr%20revised%208-08-17%20\(final-a\).pdf](http://calfire.ca.gov/resource_mgt/downloads/100%20yr%20revised%208-08-17%20(final-a).pdf)





# Appendix F: Water Use Records

## Appendix F: Water Diversion, Storage, and Use

**SWRCB Cannabis Cultivation Waste Discharge Regulatory Program**  
**Site Management Plan**  
 Water Diversion, Storage, and Use

Name: New Earth Farms, LLC, Willow Creek  
 APN: 522-024-001  
 Year: 2019

### Total surface water diversion by source and month (gallons)

Source	Jan	Feb	March	April	May	June	July	Aug	Sept	Oct	Nov	Dec	Total
Well													-
<b>Total</b>													-

### Water input to storage by source and month (gallons)

Source	Jan	Feb	March	April	May	June	July	Aug	Sept	Oct	Nov	Dec	Total
Water Storage Tanks													
													-

### Water use by source and month (gallons)

Use-Source	Jan	Feb	March	April	May	June	July	Aug	Sept	Oct	Nov	Dec	Total
Cannabis-Storage													-
Cannabis-Well													-

*\*Note: data is an approximation and is subject to change upon further analysis.  
NorthPoint Consulting*



# **Appendix G: Fertilizer, Pesticide, Herbicide, and Rodenticide Product List and Records**







# **Appendix H: Monthly BPTC Monitoring and Maintenance Records**



## Appendix H: Monthly BPTC Monitoring and Maintenance Records

Monitoring Data Sheet for SWRCB Cannabis Regulatory Program  
(BPTC Effectiveness Monitoring)

Inspector(s): \_\_\_\_\_ Date: \_\_\_\_\_

Owner: \_\_\_\_\_ APN: 522-024-001

Inspection Period (Circle)     < Oct 15,     < Dec 15,     0.5 in/day or 1 in/7 days

Other: \_\_\_\_\_

\* **G** - Good Condition (working as designed), **M** - Maintenance (needs maintenance to work properly), **R** - Replacement (needs to be reconstructed)

Site Feature	Priority	*Condition: G/M/R	Comment
DRC #1	Immediate (before rainy season)		Clean / clear and open crushed inlet before onset of each rainy season. Replace structure with 18-inch diameter Ditch Relief Culvert (DRC) if damaged to point of no longer functioning.
DRC #2	Moderate		Inspect and clean / clear inlet before onset of each rainy season.
DRC #3	Immediate (before rainy season)		Clean / Clear plugged inlet before onset of each rainy season. Replace structure with 18-inch diameter Ditch Relief Culvert (DRC) if damaged to point of no longer functioning.
Cultivation Area #1	High at end of harvest season		Plant cover crops in all soil beds, remove all plastics, trash and nutrient or fertilizer containers / items.
Cultivation Area #2	High at end of harvest season		Plant cover crops in all soil beds, remove all plastics, trash and nutrient or fertilizer containers / items.
Cultivation Area #3	High at end of harvest season		Plant cover crops in all soil beds, remove all plastics, trash and nutrient or fertilizer containers / items.



Map Point	Priority	*Condition: G/M/R	Comment
Cultivation Area #4	High at end of harvest season		Plant cover crops in all soil beds, remove all plastics, trash and nutrient or fertilizer containers / items.
STX -1	Low		Monitor crossing to ensure active erosion is not occurring.
STX -2	Moderate (before rainy season)		Clear inlet of sediment / raked woody debris. Inspect outlet for signs of erosion. Replace with appropriately sized culvert when authorized to do so.
STX -3	Low (before rainy season)		Clear inlet, ensure open and flowing at full capacity.
STX -4	Low (before rainy season)		Clear inlet, ensure open and flowing at full capacity.
STX -5	Moderate (before rainy season)		Clear inlet of sediment / raked woody debris. Inspect outlet for signs of erosion. Replace with appropriately sized culvert when authorized to do so.
STX -6	High (before rainy season)		Clear inlet of sediment / raked woody debris at trash rack. Inspect outlet for signs of erosion. Replace with appropriately sized culvert when authorized to do so.
STX -7	Moderate (before rainy season)		Clear inlet of sediment / raked woody debris. Inspect outlet for signs of erosion. Replace with appropriately sized culvert when authorized to do so.
STX -8	Low (before rainy season)		Clear inlet of sediment / raked woody debris. Inspect outlet for signs of erosion. Replace with appropriately sized culvert when authorized to do so.
STX -9	Moderate (before rainy season)		Clear inlet of sediment / raked woody debris. Inspect outlet for signs of erosion. Replace with appropriately sized culvert when authorized to do so.



Map Point	Priority	* Condition: G/M/R	Comment
STX -10	Moderate (before rainy season)		Clear inlet of sediment / raked woody debris. Inspect outlet for signs of erosion. Replace with appropriately sized culvert when authorized to do so.
STX -11	High (before rainy season)		Clear inlet of sediment / raked woody debris. Inspect outlet for signs of erosion. Replace with appropriately sized culvert when authorized to do so.
STX -12	Moderate (before rainy season)		Clear inlet of sediment / raked woody debris. Inspect outlet for signs of erosion. Ensure contributing inboard ditch is functioning and not clogged with sediment. Replace with appropriately sized culvert when authorized to do so.
STX -13	Low (before rainy season)		Maintain inboard ditch (clear sediment to facilitate flow, remove to an area that will not deliver to surface waters).
STX -14	High (before rainy season)		Remove existing broken trash rack. Clear inlet of sediment / raked woody debris. Inspect outlet for signs of erosion. Replace with appropriately sized culvert when authorized to do so.
STX -15	High (before rainy season)		Remove existing broken trash rack. Clear inlet of sediment / raked woody debris. Inspect outlet for signs of erosion. Replace with appropriately sized culvert when authorized to do so.
STX -16	High (before rainy season)		Remove existing broken trash rack. Clear inlet of sediment / raked woody debris. Inspect outlet for signs of erosion. Replace with appropriately sized culvert when authorized to do so.
Road Point (Spring) adjacent STX -3	High (before rainy season)		A proposed rolling dip (rocked) will outlet flows from the spring emerging from the cut bank of Secondary Access Road, currently eroding the outboard fill portion of the right access road to STX -3. To ensure further erosion of the road surface, a hand cut cross road drain should be installed to dewater the failing portion of the road.
Road Point (Spring) adjacent	Moderate		A proposed rocked dip will outlet flows from the spring emerging from the cut bank of the "Main Access Road". Until a rocked dip can be installed, a hand cut cross road drain should be installed to prevent continued erosion and degradation of the road surface leading to STX -9.

\* G - Good Condition (working as designed), M - Maintenance (needs maintenance to work properly), R - Replacement (needs to be reconstructed)