

Revisions for new cultivation area on pg 113

Site Management Plan

(Tier 1, Low Risk)

WDID - 1_12CC417900

Humboldt County
APN: 211-372-006

Prepared by:



165 South Fortuna Boulevard, Fortuna, CA 95540
707-725-1897 • fax 707-725-0972
trc@timberlandresource.com

2/18/2020

Arrangement of Document Contents

- Purpose
- Tier Designation
- Scope of Report
- Methods
- Property Description
- General Location Map
- Project Description
- Additional Project Permitting
- **General Compliance Guide for Cannabis Cultivators**
 - Land Development and Maintenance, Erosion Control, and Drainage Features
 - Cleanup, Restoration, and Mitigation
 - Stream Crossing Installation and Maintenance
 - Soil Disposal and Spoils Management
 - Riparian and Wetland Protection and Management
 - Water Storage and Use
 - Fertilizers, Pesticides, and Petroleum Products
 - Cultivation Related Waste
 - Refuse and Domestic Waste
 - Annual Winterization Measures
- **Statement of Limitations**
- **Site Maps**
- **Implementation Schedule**
- **Mitigation Report tables**
- **Applicable BPTC's (BMP's)**
- **Monitoring Plan**
- **Attachments**
- **Applicable Technical Documents**
 - Site Management Plan (SMP)
 - "Engineering Geologic Evaluation of Existing Pond Embankment" report provided by SHN Consulting Engineers & Geologists of Eureka, CA (Reference #: 019149)
 - "Grading, Drainage & Erosion Control Plan" provided by Omsberg & Preston Surveyors, Planners & Engineers of Eureka, CA (Job #: 18-2049)
 - Wetland Delineation provided by Kyle Wear
- **Pictures**

Purpose

This Site Management Plan (SMP) has been prepared on behalf of the cannabis cultivator for the Humboldt County property identified as assessor parcel numbers 211-372-006, by agreement and in response to the State Water Resources Control Board Cannabis Cultivation Policy (Cannabis Policy), in congruence with Order WQ 2019-0001-DWQ General Waste Discharge Requirements for Discharges of Waste Associated with Cannabis Cultivation Activities (General Order). The General Order implements the Cannabis Policy requirements, specifically those requirements that address waste discharges associated with cannabis cultivation activities. Cannabis cultivators covered under the General Order are subject to the requirements of the Cannabis Policy in its entirety. The Cannabis Policy provides a statewide tiered approach for permitting discharges and threatened discharges of waste from cannabis cultivation and associated activities, establishes a personal use exemption standard, and provides conditional exemption criteria for activities with a low threat to water quality.

Tier Designation

Tiers are defined by the amount of disturbed area. Tier 1 outdoor commercial cultivation activities disturb an area equal to or greater than 2,000 square feet and less than 1 acre (43,560 square feet). Tier 2 outdoor commercial cultivation activities disturb an area equal to or greater than 1 acre. Risk designation for Tier 1 and Tier 2 enrollees under the Cannabis Policy is based on the slope of disturbed areas and the proximity to a surface water body. Characterization is based on the risk designation summarized in Table 1 below.

Table 1: Summary of Risk Designation

Low Risk	Moderate Risk	High Risk
<ul style="list-style-type: none"> • No portion of the disturbed area is located on a slope greater than 30 percent, and • All of the disturbed area complies with the setback requirements. 	<ul style="list-style-type: none"> • Any portion of the disturbed area is located on a slope greater than 30 percent, and • All of the disturbed area complies with the setback requirements. 	<ul style="list-style-type: none"> • Any portion of the disturbed area is located within the setback requirements.

Thorough assessment of the project area including roads, disturbed areas, legacy features, and cultivation areas classify this enrollment into the **Tier 1, Low Risk** designation.

Scope of Report

Tier 1 and Tier 2 cannabis cultivators are required to submit and implement a Site Management Plan that describes how they are complying with the Requirements listed in Attachment A. The description shall describe how all applicable Best Practicable Treatment or Control (BPTC) measures are implemented. Cannabis cultivators within the North Coast Regional Water Quality Control Board jurisdiction are required to submit and implement Site Management Plans that describe how the Requirements are implemented property-wide, to include legacy activities. The SMP includes an Implementation Schedule to achieve compliance, but all work must be completed by the onset of the Winter Period each year. Projects designated as Moderate Risk are also required to have a Site Erosion and Sediment Control (plan) to achieve the goal of minimizing the discharge of sediment off-site. Projects designated as High Risk are also required to have a Disturbed Area Stabilization Plan to achieve the goal of stabilizing the disturbed area to minimize the discharge of sediment off-site and comply with the setback requirements. The cannabis cultivator shall ensure that all site operating personnel are familiar with the contents of the General Order and all technical reports prepared for the property. Projects which have over one acre of cannabis cultivation (total canopy area) are also required to have a Nitrogen Management Plan to describe how nitrogen is stored, used, and applied to crops in a way that is protective of water quality. A copy of the General Order, and technical reports required by the General Order, shall be kept at the cultivation site. Electronic copies of these documents are acceptable. Either format of maintained documents kept on site must be immediately presentable upon request.

Methods

The methods used to develop this SMP include both field and office components. The office component consisted of aerial photography review and interpretation, existing USGS quad map review, GIS mapping of field data, review of on-site photography points, streamflow calculations, general planning, and information gathered from the cannabis cultivator and/or landowner. The field component included mapping of all access roads, vehicle parking areas, Waters of the State, stream crossings, drainage features, cultivation sites, buildings, disturbed areas, and all other relevant site features within the project area and surrounding areas (as feasible). Cultivation areas, associated facilities, roads, and other developed and/or disturbed areas were assessed for discharges and related controllable water quality factors from the activities listed in the General Order. The field assessment also included an evaluation and determination of compliance with all applicable BPTC's per Section 2 of the General Order.

Property Description

The property assessed consists of one parcel totaling 80 acres located approximately 2.5 miles northeast of Miranda, California, at an elevation of approximately 1,800 feet above mean sea level. The property is located in Section 25, T2S, R3E, HB&M, Humboldt County, from the Myers Flat USGS 7.5' Quad. Elk Creek flows east-west through the property that drains to South Fork Eel River, which is tributary to the Eel River.

Site Management Plan

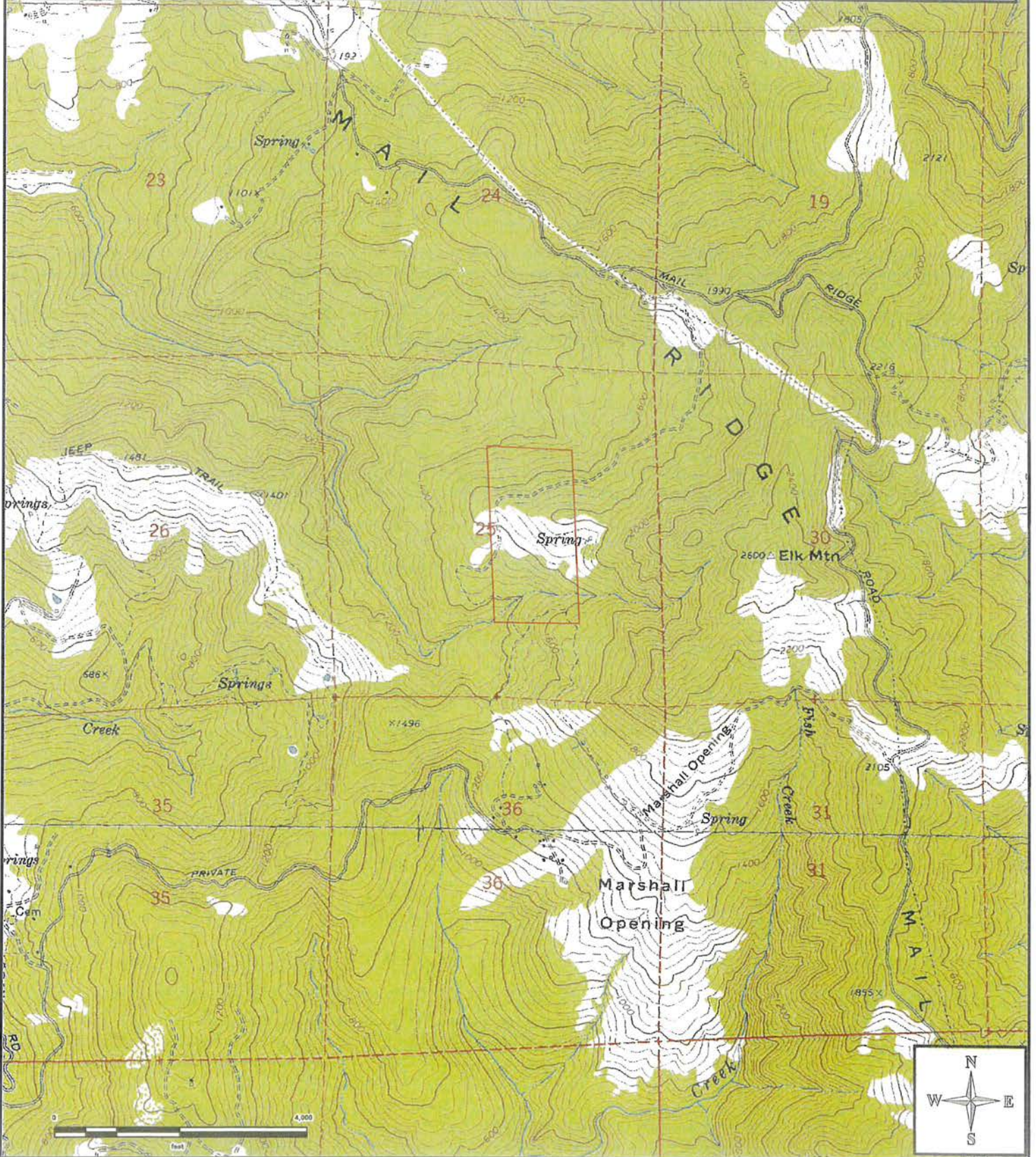
General Location Map [WDID - 1_12CC417900]



 Property Boundary

Located in Section 21, T2S, R3E, HB&M, Humboldt County, from the Myer's Flat 7.5' USGS Quad Map

TRC - 106



Project Description

Cannabis cultivation on the property consists of two 35' x 140' greenhouses, for a total, general cultivation area¹ of 4,900 ft². The cultivation area is located within 18,950 ft² of disturbed area. This project is being permitted by Humboldt County to cultivate cannabis. This project was previously enrolled in the North Coast Regional Water Quality Control Board Order No. R1-2015-0023 under WDID-1 B161025CHUM and has since enrolled with State Water Recourses Control Board as WDID-1_12CC417900. This project is being classified as Tier 1, Low Risk.

Table 1: Cultivation Site Parameters.

Cultivation Area	Land Disturbance Area (ft ²)	General Cultivation Area ¹ (ft ²)	Adjoining Hillslopes (% Grade)
A	18,950	4,900	15 - 25%
Totals:	18,950	4,900	

¹ Area refers to the total land disturbance area. The total cannabis canopy area may vary considerably than the disturbance area.

Table 2: Project Permitting

Additional Required Permits Related to Project, Type, and Status	
SIUR	Small Irrigation and Use Registration Filed with Division of Water Rights – #H508360
LSAA/1600	Submitted

Baseline Assessment of Requirements Related to Water Diversions and Waste Discharge for Cannabis Cultivation

This project was previously enrolled in the North Coast Regional Water Quality Control Board Order No. 2015-0023. A Water Resource Protection Plan (WRPP) was prepared by Timberland Resource Consultants. Some mitigations prescribed in the WRPP have since been completed. A re-assessment of the project was conducted and will be used as the baseline assessment for the preparation of this document.

Land Development and Maintenance, Erosion Control, and Drainage Features

Project Compliance Y/N

Roads are being classified as “permanent” (roads appurtenant to the project being used year-round), “seasonal” (roads appurtenant to the project being used primarily during summer months), “legacy” (roads not appurtenant to the project receiving little to no use), and “trail” (being used for occasional access to features on the property).

Roads within the project area appear to have a low native rock component and high imported rock component and, based on observations of surface erosion relative to current surface drainage break frequency, are being classified as having moderate erodibility. This classification will be utilized to determine surface/ditch-line drainage break frequency based on Table 19 of the Handbook for Forest Ranch and Rural Roads, 2014.

TABLE 19. Recommended maximum rolling dip and ditch relief culvert spacing, in feet, based on road gradient and soil erodibility ^{1,2}

Soil erodibility	Road gradient (%) and drainage structure spacing (feet)				
	0-3	4-6	7-9	10-12	>12
High to moderate	250	160	130	115	100
Low	400	300	250	200	160

Currently, all permanent roads on the property have imported rock surfacing. Some sections of permanent and seasonal roads require additional rock surfacing. These segments are identified in the attached Mitigation Report.

Roads assessed by TRC were found to be in generally in acceptable condition with imported rock surfacing. The entire road system on this property, besides the seasonal road to Site 16, has been reshaped, rock surfaced, and upgraded to incorporate adequate surface and ditchline drainage features. However, certain sections of permanent road (Sites 02, 04, & 10) require additional rock surfacing to prevent rutting and to establish a stable road base. These sites have shown through the first winter period, post upgrading during the fall of 2019, that they require additional rock surfacing touch ups. The sections of permanent roads that require either the maintenance of existing drainage features (Sites 01, 02, 03, 04), and installation of new drainage features (Site 05 & 08). At Sites 04 & 10 wheel ruts were observed. Recent re-shaping of the road has resulted in a softening of the road surface and in certain sections the rock surfacing is inadequate. At Sites 02

and 04, wheel ruts exist for only approximately 50 feet over a newly installed ditch relief culverts. At Site 10, wheel ruts exist for only approximately 100 feet on a permanent access road.

Controllable Sediment Delivery Sites (CSDS) were found on the property. Runoff and sediment from the inside ditch coming from Site 09 and the unstable road surface at Site 10 was found discharging into surface waters. See the attached photographs, Mitigation Report, Treatment Implementation Schedule, and Site Map to follow for site specific details and treatments.

No notable erosion of the road surface was observed anywhere on the property. No additional road surface drainage features are being prescribed.

No erosion of the cultivation area or past cultivation area was observed.

No unstable areas were observed on the property.

Cleanup, Restoration, and Mitigation:

Project Compliance Y /N

No revegetation besides seeding and mulching disturbed areas or sediment catchment sites are being prescribed.

Stream Crossing Installation and Maintenance:

Project Compliance Y /N

Four watercourse crossings were identified during the assessment of the property. Two watercourse crossings (Sites 11 & 12) shall be upgraded as there is either no existing crossing (Site 11) or the existing ford crossing was found to be inadequate (Site 12). Two other watercourse crossings (Sites 21 & 22) are located on an unused legacy road that is not used or required by the landowner. However, the landowner does not have easement to access this road via adjacent property owners. Decommissioning or upgrading of these crossings is not being prescribed due to there being no access to them. See attached photographs, Mitigation Report, Treatment Implementation Schedule, and Site Map to follow for site specific details and treatments.

A Lake and Streambed Alteration Agreement (LSAA/1600) with California Department of Fish & Wildlife (CDFW) has been finalized as of the writing of this assessment for the proposed work on watercourse crossings at Site 11 & 12. Any additional work in watercourses will require an amendment to an existing LSAA/1600 or a new LSAA/1600 with CDFW. Any additional guidelines, treatments, or restrictions set forth under the finalized Lake and Stream Alteration Agreement shall be followed.

Table 3: Stream Crossing Hydrology

Site ID_NUMBER	Area (ac)	K_VALUE	Elevation (ft) Culvert Elevation	Elevation (ft) Drainage Divide	Length (mi)	CMP_DIA (in)
Site 11	3.24	0.35	1560	1700	0.1548	
Site 12	3.54	0.35	1560	1760	0.1425	
Site 21	17.50	0.35	1400	1760	0.335	24
Site 22	154.00	0.35	1400	2600	0.854	36

Precipitation Depth-Duration-Frequency Values Mean Annual Rainfall (in) = **55**

50-Year Storm			100-Year Storm		
Time, Min	Depth (in)	Inch/hr.	Time, Min.	Depth (in)	Inch/hr.
10	0.400	2.40	10	0.536	3.22

ID#	Coef. (K)	Index (1000's ft.)	Concen. (min)	Intensity (in/hr)	Annual Rainfall (in)	Area (ac)	Discharge Method	RATIONAL (cfs)	USGS MF (cfs)
Site 11	0.35	0.0	3	3.22	55	3.24	RATIONAL	3.65	4.63
Site 12	0.35	0.0	2	3.22	55	3.54	RATIONAL	3.98	5.00
Site 21	0.35	0.0	5	3.22	55	17.50	RATIONAL	19.70	19.94
Site 22	0.35	0.0	8	3.22	55	154.00	USGS MF	173.34	131.11

ID#	Existing Culvert (D) Diameter (in)	Headwall (HW) Height (in)	Selected HW/D (ratio)	Discharge Method	Q100 (cfs)	Culvert Capacity (cfs)	Culvert is Undersized	Recommended Culvert Dia. (in)	Recommendation Based On
Site 11	0	0	0.0	RATIONAL	3.65	0.00	TRUE	18	Q100
Site 12	0	0	0.0	RATIONAL	3.98	0.00	TRUE	18	Q100
Site 21	24	0	0.0	RATIONAL	19.70	7.10	TRUE	42	Q100
Site 22	36	0	0.0	USGS MF	131.11	19.50	TRUE	84	Q100

Soil Disposal and Spoils Management:

Project Compliance Y /N

Currently, no spoils are present on the property. Any/all spoils generated through development or maintenance of roads, driveways, earthen fill pads, or other cleared or filled areas have not been sidecast in any location where they can enter or be transported to surface waters. Any/all future spoils generated as a result of any future construction projects that are to be stored on the property shall be done so in accordance with the BTPC.

Riparian and Wetland Protection and Management:

Project Compliance Y/N

No disturbed areas were identified as being within riparian areas.

Table 4: Riparian and Wetland Protection and Management

Disturbed Area	Disturbance Area Distances and Riparian Setbacks ²				
	Class I [Setback: 100'] ²	Class II [Setback: 100']	Class III [Setback: 50']	Perennial Spring or Wetland [Setback: 50'] ²	Disturbed Area Within Setbacks [ft ²]
Cultivation Area A	>200'	>200'	>200'	~110'	0
				Total =	0

²This enrollment was previously enrolled in RWQCB Order No 2015-0023 and as such may retain reduced setbacks that were applicable under the previous Order.

Water Storage and Use:

Project Compliance Y/N

All water on the property is derived from a off-stream rain catchment pond, well, and a surface water diversion located on the property. The off-stream rain catchment pond, well, and surface water diversion meet and exceed the required water demands for both domestic and agricultural use. The POD will potentially be used for domestic and for topping off the pond prior to the forbearance season, if needed. Currently though, between the well and rain catchment pond, regular use of the surface water diversion is expected. At present there are no metering devices or procedures (water sourced from non-jurisdictional wells do not require meters) in place to record water usage associated with the irrigation of cannabis or domestic uses. A metering device and/or a procedure shall be installed or used in early 2020 to record all water diverted, pumped water, and used for the irrigation of cannabis and domestic use. Monthly water usage shall be recorded for annual reporting purposes.

Water is stored in one 2,600-gallon tank, three 3,000-gallon tanks, and an approximately 350,000-gallon rain-catchment pond. There is also a 22,000-gallon and 25,000-gallon water storage bladder located on the property. These water storage bladders are no longer used with the installation of the rain catchment pond and future use of them is not planned. Fertilizer mixing occurs in one 550-gallon and one 1550-gallon tank. Multiple water storage tanks were found to have lids not in place to prevent access and entrapment of wildlife. Tank lids shall be kept closed at all times when access is not needed. Tanks that do not utilize lids shall be retrofitted to be enclosed from wildlife. Overflow prevention measures shall be installed on water storage and transfer infrastructure or water storage tanks to prevent the overflowing of tanks and unnecessary waste of water resources when water

storage infrastructure has filled. Water conservation measures such as drip line irrigation, morning or evening watering, and mulch or cover cropping of cultivated top soils shall also be implemented.

At this time, the cannabis cultivator has 361,600 gallons of water storage installed. Based on estimates, this volume of storage combined with the output from the well is sufficient to allow for full forbearance during the required period from April 1st to October 31st. Monthly water usage estimates and the season total are as follows below.

Table 5: Estimated Annual Water Use

	Jan	Feb	March	April (15%)	May (40%)	Jun (80%)	Jul (100%)	Aug (100%)	Sep (70%)	Oct (20%)	Nov	Dec
Agriculture				2,279	5,880	11,760	14,700	14,700	10,290	2,940		
Sq. ft. =	% = percent of peak usage											
4,900												
Total AG Water Use =											62,549	

Cannabis cultivators should be advised that transition to the state General Order will require additional infrastructure to use bladders for water storage.

There is domestic water use at this time on this property. Water meter(s) and water supply infrastructure shall be designed/installed in a manner such that water usage for the irrigation of cannabis can be recorded separately from water used for domestic use. Additionally, if there are multiple diversions of surface water, infrastructure/metering device(s) shall be design/installed in a manner that each source of surface water is recorded separately.

A Lake and Streambed Alteration Agreement with the California Department of Fish and Wildlife, as well as an Initial Statement of Water Diversion and Use and a Small Irrigation and Use Registration with the California State Water Resource Control Board Division of Water Rights, has been finalized as of the writing of this assessment. Any additional guidelines, treatments, or restrictions set forth under the finalized Lake and Stream Agreement shall be followed.

Irrigation Runoff:

During visits to the property, no irrigation runoff, or evidence of such runoff, was observed at any of the cultivation areas.

Fertilizers, Soils, Pesticides, and Petroleum Products:

Project Compliance Y / N

Fertilizers, pesticides, potting soils, compost, and other soils and soil amendments are not stored currently on the property in a manner in which they can enter or be transported into surface waters and so that nutrients or other pollutants can be leached into groundwater. Cultivation areas are currently maintained so as to prevent nutrients from leaving the site during the growing season and post-harvest.

Fertilizers and soil amendments shall be applied and used per the manufacturer's guidelines. The use of pesticide products shall be consistent with product labeling and all products on the property

are to be stored in closed structures to ensure that they do not enter or are released into surface or ground waters.

Currently, bulk fuel storage and associated petroleum products are present on the property. Diesel fuel is stored in a 250-gallon and 500-gallon fuel tank with secondary containment and cover from precipitation. Fuel is also stored and transferred from in-bed auxiliary fuel tanks installed onto trucks. Small quantities of fuel are also stored within fuel canisters and motor oil is stored the original motor oil container, alongside small generators that power fertilizer mixing tanks. Neither the fuel and motor oil or the small generators have secondary containment. The Cultivator was in the process of installing a foundation and secondary containment for a stationary generator during the site assessment. If trailered generators are used, they shall have adequate secondary containment and if they are used during the winter period, also have adequate cover from precipitation.

Any/all fuel canisters, motor oil containers, and generators (large or small) shall be stored in secondary containment (e.g. drip pans, plastic totes, or sealed metal boxes) while being stored long term or not in immediate use, wherever these materials are used anywhere on the property. See the Mitigation Report, Treatment Implementation Schedule, and Site Map to follow for site specific details and treatments.

Any/all future petroleum products and other liquid chemicals, including but not limited to diesel, biodiesel, gasoline, and oils shall be stored so as to prevent their spillage, discharge, or seepage into receiving waters. Storage tanks and containers shall be of suitable material and construction to be compatible with the substance(s) stored and conditions of storage such as pressure and temperature. Above ground storage tanks and containers shall be provided with a secondary means of containment for the entire capacity of the largest single container and sufficient cover shall be provided to prevent any/all precipitation from entering said secondary containment vessel. Cannabis cultivators shall ensure that diked areas are sufficiently impervious to contain discharged chemicals. Cannabis cultivators shall implement spill prevention, control, and countermeasures (SPCC) and have appropriate cleanup materials available onsite if the volume of a fuel container is greater than 1,320 gallons. Underground storage tanks 110 gallons and larger shall be registered with the appropriate County department and comply with state and local requirements for leak detection, spill overflow, corrosion protection, and insurance coverage. On site storage of petroleum products, or other fuels used for commercial activities may require registration as hazardous materials through the California Environmental Reporting System (CERS). Additionally, any waste oil generated from commercial activities (generators) is considered by the state hazardous waste and requires addition reporting. This cannabis cultivator is advised to contact local agencies to find out if such reporting is applicable to currently operations.

Cultivation-Related Wastes:Project Compliance Y /N

No cultivation-related wastes, including, but not limited to, empty soil/soil amendment/fertilizer/pesticide bags and containers, empty plant pots or containers, dead or harvested plant waste, and spent growth medium, are stored in locations where they can enter or be blown into surface waters, or in a manner that could result in residues and pollutants within such materials to migrate or leach into surface water or groundwaters.

Organic cultivation-related wastes are collected from the cultivation areas and either disposed of properly with general waste or composted. The cannabis cultivator shall ensure that the locations where organic wastes are stored or composted are minimized in number and are sited outside of watercourse riparian areas and away from any form of surface runoff.

Non-organic cultivation-related wastes are stored in lidded trashcans and garbage bags adjacent to or in the residence, sheds, and cultivation areas and are disposed of regularly at a solid waste transfer station. The cannabis cultivator shall continue to gather and properly dispose of cultivation-related wastes and ensure that wastes are adequately contained from scavenging wildlife, and cannot be transported away from storage areas by wind or surface runoff.

Refuse and Domestic Waste:Project Compliance Y /N

Garbage and refuse are stored on the property within lidded trash cans and garbage bags and are disposed of regularly at the nearest solid waste transfer station. The cannabis cultivator shall continue to gather and properly dispose of refuse and ensure that refuse is adequately contained from scavenging wildlife, and cannot be transported away from storage areas by wind or surface runoff.

Human waste is managed by a permitted septic system on site. It is the cannabis cultivator's responsibility to ensure compliance of such action with the Humboldt County Department of Environmental Health and Human Services.

STATEMENT OF CONTINGENT AND LIMITING CONDITIONS CONCERNING THE PREPARATION AND USE OF REPORTS ADDRESSING GENERAL WASTE DISCHARGE REQUIREMENTS UNDER ORDER WQ 2017-0023-DWQ

Prepared by Timberland Resource Consultants

1. This document has been prepared for the property within APN 220-011-018-000, 220-011-002-000, in Humboldt County, for enrollment in the General Waste Discharge Order WQ 2019-0001-DWQ.
2. Timberland Resource Consultants does not assume any liability for the use or misuse of the information in this document.
3. The information is based upon conditions apparent to Timberland Resource Consultants at the time inspection(s) were conducted. Changes due to land use activities or environmental factors occurring after inspection, have not been considered in this document.
4. Maps, photos, and any other graphical information presented in this report are for illustrative purposes. Their scales are approximate, and they are not to be used for locating and establishing boundary lines.
5. The conditions presented in this document may differ from those made by others or from changes on the property occurring after inspections were conducted. Timberland Resource Consultants does not guarantee this work against such differences.
6. Timberland Resource Consultants did not conduct an investigation on a legal survey of the property.
7. Persons using this document are advised to contact Timberland Resource Consultants prior to such use.
8. Timberland Resource Consultants will not discuss this document or reproduce it for anyone other than the Client for which this document was prepared without authorization from the Client.



Forrest Hansen

Timberland Resource Consultants

Site Management Plan

Site Map [WDID - 1_12CC417900]



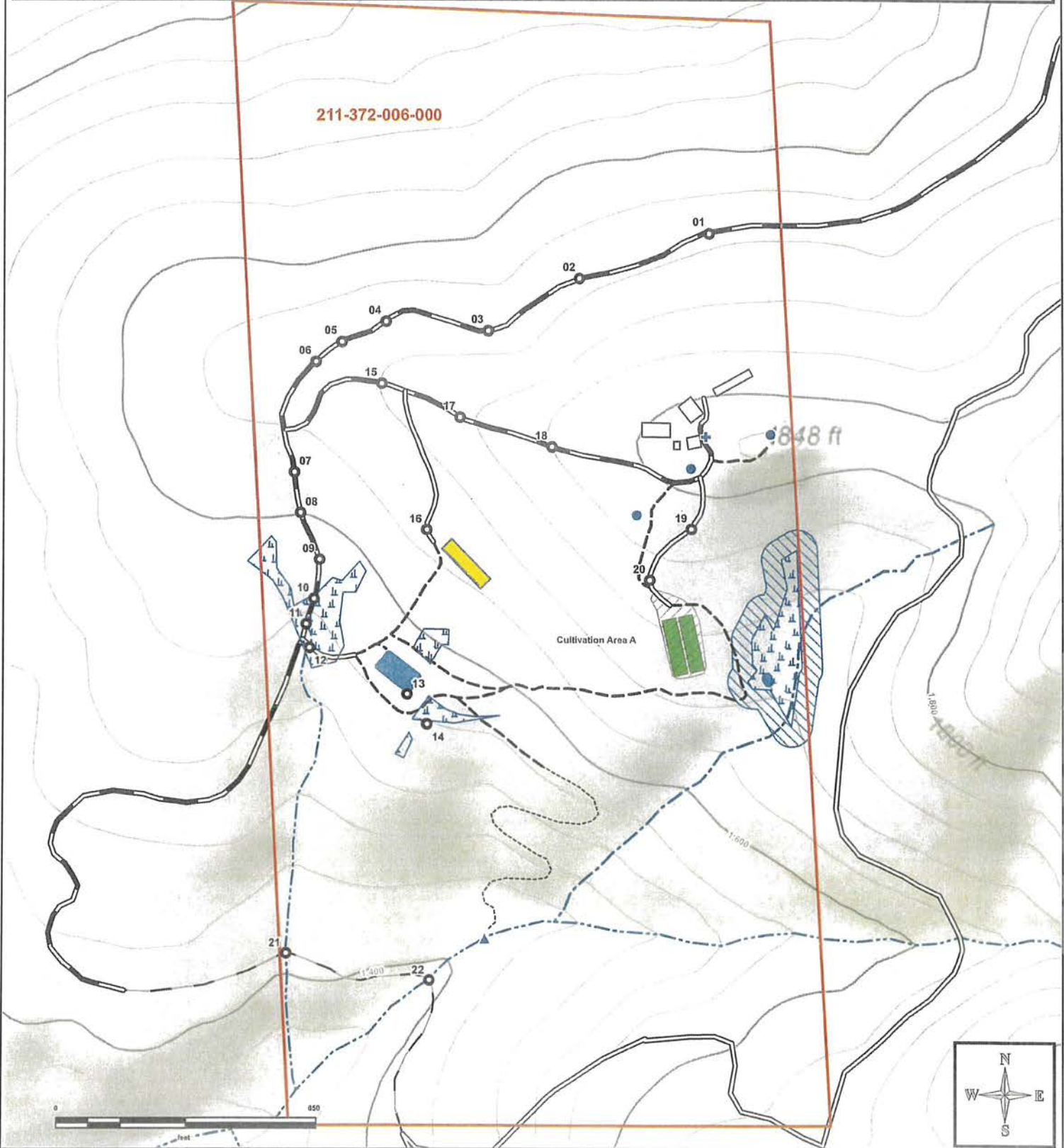
- Property Boundary
- Delineated Wetland
- Cultivation Area
- Riparian Area
- Disturbed Area
- Pond
- Past Cultivation
- Structure

- Watercourses**
- Class II
 - Class III
- Roads**
- Permanent
 - Seasonal Access
 - Trail
 - Foot Trail
 - Legacy

- Site
- POD
- Tank
- Well

40' contour intervals
Map Date 2/6/2020

TRC - 106











Site Management Plan

Site Map [WDID - 1_12CC417900]



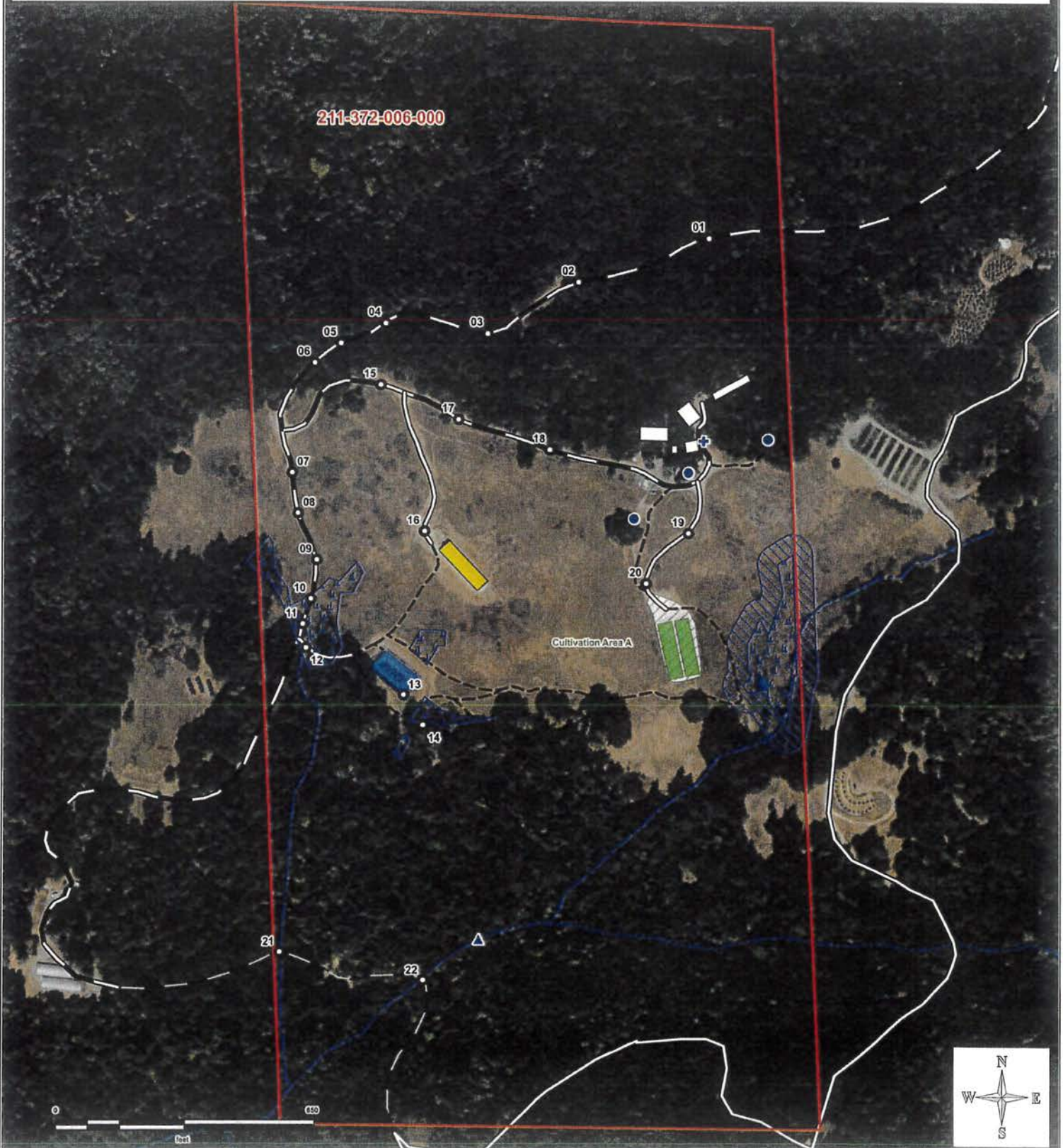
2018 NAIP DOQ
Map Date 2/6/2020

-  Property Boundary
-  Cultivation Area
-  Disturbed Area
-  Structure
-  Delineated Wetland
-  Riparian Area
-  Pond
-  Past Cultivation

- Watercourses**
-  Class II
-  Class III
- Roads**
-  Permanent
-  Seasonal Access
-  Trail
-  Foot Trail
-  Legacy

-  Site
-  POD
-  Tank
-  Well

TRC - 106





Treatment Implementation Schedule

Unique Point	Proposed Work Completion Date
Immediately	
Past Cultivation Areas	Immediately
Water Storage and Use	Immediately
Liquid Petroleum Products	Immediately
Generators and Gas Powered Pumps	Immediately
Prior to 10/15/2021	
Site 1	Prior to 10/15/21
Site 2	Prior to 10/15/21
Site 3	Prior to 10/15/21
Site 4	Prior to 10/15/21
Site 5	Prior to 10/15/21
Site 6	Prior to 10/15/21
Site 7	Prior to 10/15/21
Site 8	Prior to 10/15/21
Site 9	Prior to 10/15/21
Site 10	Prior to 10/15/21
Site 11	Prior to 10/15/21 pending the approval of any required permits
Site 12	Prior to 10/15/21 pending the approval of any required permits
Site 14	Prior to 10/15/21
Site 18	Prior to 10/15/21
As required/Annually prior to 10/15	
Site 13	As required
Site 15	As required
Site 16	As required
Site 17	As required
Site 20	As required
Site 21	Annually prior to 10/15



SMP - Mitigation Report

WDID# - 1_12CC417900

Unique Point	Lat-Long NAD 83	Road Type	Mitigation Planned	Monitor	1600	Treatment Priority	Date Completed
Site 1	-123.784969 40.264916	Permanent	X	X	-	Prior to 10/15/21	
Current Condition: Ditch relief culvert consisting of a 15" diameter smooth-walled plastic pipe that. This ditch relief culvert is functioning adequately, however it lacks a sufficient rock armor energy dissipater at the outlet.						Prescribed Action: Hand place and key in rock armoring around the outfall of the culvert per the specifications outlined in the attached BMPs: See Permanent Culvert Crossing Design: Inlet and Outlet Armoring.	
Unique Point	Lat-Long NAD 83	Road Type	Mitigation Planned	Monitor	1600	Treatment Priority	Date Completed
Site 2	-123.78613 40.264609	Permanent	X	X	-	Prior to 10/15/21	
Current Condition: Ditch relief culvert consisting of a 15" diameter smooth-walled plastic pipe that. This ditch relief culvert is functioning adequately, however it lacks a sufficient rock armor energy dissipater at the outlet. Rutting of the road surface is also occurring above this ditch relief culvert due to the lack of adequate competent rock surfacing on this section of road.						Prescribed Action: Apply competent road rock surfacing(approximately 4" - 6" crushed angular rock) to the road surface along this section of road where rutting is occurring. Hand place and key in rock armoring around the outfall of the culvert per the specifications outlined in the attached BMPs: See Permanent Culvert Crossing Design: Inlet and Outlet Armoring.	
Unique Point	Lat-Long NAD 83	Road Type	Mitigation Planned	Monitor	1600	Treatment Priority	Date Completed
Site 3	-123.786942 40.264252	Permanent	X	X	-	Prior to 10/15/21	
Current Condition: Ditch relief culvert consisting of a 15" diameter smooth-walled plastic pipe that. This ditch relief culvert is functioning adequately, however it lacks a sufficient rock armor energy dissipater at the outlet.						Prescribed Action: Hand place and key in rock armoring around the outfall of the culvert per the specifications outlined in the attached BMPs: See Permanent Culvert Crossing Design: Inlet and Outlet Armoring.	
Unique Point	Lat-Long NAD 83	Road Type	Mitigation Planned	Monitor	1600	Treatment Priority	Date Completed
Site 4	-123.787852 40.264314	Permanent	X	X	-	Prior to 10/15/21	
Current Condition: Ditch relief culvert consisting of a 15" diameter smooth-walled plastic pipe that. This ditch relief culvert is functioning adequately, however it lacks a sufficient rock armor energy dissipater at the outlet. Rutting of the road surface is also occurring above this ditch relief culvert due to the lack of adequate competent rock surfacing on this section of road.						Prescribed Action: Apply competent road rock surfacing(approximately 4" - 6" crushed angular rock) to the road surface along this section of road where rutting is occurring. Hand place and key in rock armoring around the outfall of the culvert per the specifications outlined in the attached BMPs: See Permanent Culvert Crossing Design: Inlet and Outlet Armoring.	
Unique Point	Lat-Long NAD 83	Road Type	Mitigation Planned	Monitor	1600	Treatment Priority	Date Completed
Site 5	-123.788245 40.264177	Permanent	X	X	-	Prior to 10/15/21	
Current Condition: Natural low point in the road grade that drains road surface runoff. Runoff is being constrained along the inboard edge of the road, resulting in sustained saturation of the road surface.						Prescribed Action: Install a 15" diameter ditch relief culvert per the specifications outlined in the attached BMPs: See Ditch Relief Culvert, and Permanent Culvert Crossing Design (Inlet and Outlet Armoring), General Operations BMPs, and General Erosion Control specifications.	



SMP - Mitigation Report

WDID# - 1_12CC417900

Unique Point	Lat-Long NAD 83	Road Type	Mitigation Planned	Monitor	1600	Treatment Priority	Date Completed
Site 6	-123.788474 40.264041	Permanent	-	X	-	Prior to 10/15/21	
Current Condition: Functioning rocked rolling dip.						Prescribed Action: Maintain the rolling dip to the specifications outlined in the attached BMPs. See attached BMPs: Rocked/Rolling Dip Design and Placement, General Operations BMPs, and General Erosion Control specifications.	
Unique Point	Lat-Long NAD 83	Road Type	Mitigation Planned	Monitor	1600	Treatment Priority	Date Completed
Site 7	-123.788668 40.263288	Permanent	-	X	-	Prior to 10/15/21	
Current Condition: Functioning rocked rolling dip.						Prescribed Action: Maintain the rolling dip to the specifications outlined in the attached BMPs. See attached BMPs: Rocked/Rolling Dip Design and Placement, General Operations BMPs, and General Erosion Control specifications.	
Unique Point	Lat-Long NAD 83	Road Type	Mitigation Planned	Monitor	1600	Treatment Priority	Date Completed
Site 8	-123.788611 40.263011	Permanent	X	X	-	Prior to 10/15/21	
Current Condition: Long undrained inside ditch that discharges into the head of a Class III watercourse and wetland area at Site 12.						Prescribed Action: Install a 15" diameter ditch relief culvert per the specifications outlined in the attached BMPs: See Ditch Relief Culvert, and Permanent Culvert Crossing Design (Inlet and Outlet Armoring), General Operations BMPs, and General Erosion Control specifications.	
Unique Point	Lat-Long NAD 83	Road Type	Mitigation Planned	Monitor	1600	Treatment Priority	Date Completed
Site 9	-123.788437 40.262691	Permanent	-	X	-	Prior to 10/15/21	
Current Condition: Functioning rocked rolling dip.						Prescribed Action: Maintain the rolling dip to the specifications outlined in the attached BMPs. See attached BMPs: Rocked/Rolling Dip Design and Placement, General Operations BMPs, and General Erosion Control specifications.	
Unique Point	Lat-Long NAD 83	Road Type	Mitigation Planned	Monitor	1600	Treatment Priority	Date Completed
Site 10	-123.788486 40.262424	Permanent	X	X	-	Prior to 10/15/21	
Current Condition: Rutting of the road surface is occurring for approximately 100' along this section of road.						Prescribed Action: Apply competent road rock surfacing (approximately 4" - 6" crushed angular rock) to the road surface along this section of road where rutting is occurring.	



SMP - Mitigation Report

WDID# - 1_12CC417900

Unique Point	Lat-Long NAD 83	Road Type	Mitigation Planned	Monitor	1600	Treatment Priority	Date Completed
Site 11	-123.788556 40.262252	Permanent	X	X	X	Prior to 10/15/21 pending the approval of any required permits	
Current Condition: Concentrated flows from a upland swale area concentrates and drains down an inside ditch.						Prescribed Action: Per request by CDFW and North Coast Regional Water Quality Board personnel, install an 18" D x 60' L culvert per the specifications outlined in the attached BMPs: See Permanent Culvert Crossing, Permanent Culvert Crossing Design: Critical Dip and Hydrologic Disconnect Placement, Critical Dip, Culvert Orientation, Inlet and Outlet Armoring, General Operations BMPs, and General Erosion Control specifications.	
Unique Point	Lat-Long NAD 83	Road Type	Mitigation Planned	Monitor	1600	Treatment Priority	Date Completed
Site 12	-123.788525 40.262091	Permanent	X	X	X	Prior to 10/15/21 pending the approval of any required permits	
Current Condition: Class III watercourse crossing consisting of an adequate rocked ford.						Prescribed Action: Per request by CDFW and North Coast Regional Water Quality Board personnel, upgrade the existing crossing by installing an 18" D x 20' L culvert per the specifications outlined in the attached BMPs: See Permanent Culvert Crossing, Permanent Culvert Crossing Design: Critical Dip and Hydrologic Disconnect Placement, Critical Dip, Culvert Orientation, Inlet and Outlet Armoring, General Operations BMPs, and General Erosion Control specifications.	
Unique Point	Lat-Long NAD 83	Road Type	Mitigation Planned	Monitor	1600	Treatment Priority	Date Completed
Site 13	-123.787656 40.261774	-	-	X	-	As required	
Current Condition: Off-stream rain catchment pond overflow consisting of a 12" D x 104' L corrugated plastic pipe.						Prescribed Action: None. Maintain and monitor the pond overflow for plugging.	
Unique Point	Lat-Long NAD 83	Road Type	Mitigation Planned	Monitor	1600	Treatment Priority	Date Completed
Site 14	-123.787481 40.26157	-	X	X	-	Prior to 10/15/21	
Current Condition: Water storage bladder located within a wetland area.						Prescribed Action: Remove the water storage bladder and seed and mulch any disturbed area associated with its removal, with a mix of erosion control grass and native grass seed and weed free straw(or woodchips).	
Unique Point	Lat-Long NAD 83	Road Type	Mitigation Planned	Monitor	1600	Treatment Priority	Date Completed
Site 15	-123.787888 40.263893	Permanent	-	X	-	As required	
Current Condition: Leadout drainage ditch associated with an inside ditch.						Prescribed Action: None. Maintain the leadout ditch so that ditch flows continue to be drained by it.	



SMP - Mitigation Report

WDID# - 1_12CC417900

Unique Point	Lat-Long NAD 83	Road Type	Mitigation Planned	Monitor	1600	Treatment Priority	Date Completed
Site 16	-123.787487 40.262893	Seasonal	-	X	-	As required	
Current Condition: Ditch relief culvert consisting of a 12" diameter corrugated plastic pipe that drains a drainage ditch along the cutbank of the Past Cultivation Area.						Prescribed Action: None. Maintain and monitor for plugging.	
Unique Point	Lat-Long NAD 83	Road Type	Mitigation Planned	Monitor	1600	Treatment Priority	Date Completed
Site 17	-123.787191 40.263662	Permanent	-	X	-	As required	
Current Condition: Functioning rocked rolling dip.						Prescribed Action: Maintain the rolling dip to the specifications outlined in the attached BMPs. See attached BMPs: Rocked/Rolling Dip Design and Placement, General Operations BMPs, and General Erosion Control specifications.	
Unique Point	Lat-Long NAD 83	Road Type	Mitigation Planned	Monitor	1600	Treatment Priority	Date Completed
Site 18	-123.786375 40.26346	Permanent	X	X	-	Prior to 10/15/21	
Current Condition: Ditch relief culvert consisting of a 15" diameter smooth-walled plastic pipe that. This ditch relief culvert is functioning adequately, however it lacks a sufficient rock armor energy dissipater at the outlet.						Prescribed Action: Hand place and key in rock armoring around the outfall of the culvert per the specifications outlined in the attached BMPs: See Permanent Culvert Crossing Design: Inlet and Outlet Armoring.	
Unique Point	Lat-Long NAD 83	Road Type	Mitigation Planned	Monitor	1600	Treatment Priority	Date Completed
Site 19	-123.785132 40.262898	Seasonal	-	X	-	As required	
Current Condition: Functioning rolling dip.						Prescribed Action: Maintain the rolling dip to the specifications outlined in the attached BMPs. See attached BMPs: Rocked/Rolling Dip Design and Placement, General Operations BMPs, and General Erosion Control specifications.	
Unique Point	Lat-Long NAD 83	Road Type	Mitigation Planned	Monitor	1600	Treatment Priority	Date Completed
Site 20	-123.785502 40.262552	Seasonal	-	X	-	As required	
Current Condition: Leadout drainage ditch associated with an inside ditch.						Prescribed Action: None. Maintain the leadout ditch so that ditch flows continue to be drained by it.	
Unique Point	Lat-Long NAD 83	Road Type	Mitigation Planned	Monitor	1600	Treatment Priority	Date Completed
Site 21	-123.788728 40.260016	Legacy	-	X	-	Annually prior to 10/15	
Current Condition: Class II watercourse crossing consisting of a 24" diameter corrugated metal pipe that is undersized for a 100-year storm event but functioning adequately.						Prescribed Action: None. Maintain and monitor for plugging. The cultivator does not have deeded easement access to this road, therefore decommissioning of this watercourse crossing is not being proposed.	



SMP - Mitigation Report

WDID# - 1_12CC417900

Unique Point	Lat-Long NAD 83	Road Type	Mitigation Planned	Monitor	1600	Treatment Priority	Date Completed
Site 22	-123.787452 40.259832	Legacy	-	X	-	Annually prior to 10/15	
<p>Current Condition: Class II watercourse crossing consisting of a 36" diameter corrugated metal pipe that is undersized for a 100-year storm event but functioning adequately.</p>						<p>Prescribed Action: None. Maintain and monitor for plugging. The cultivator does not have deeded easement access to this road, therefore decommissioning of this watercourse crossing is not being proposed.</p>	
Unique Point	Lat-Long NAD 83	Road Type	Mitigation Planned	Monitor	1600	Treatment Priority	Date Completed
Water Storage and Use	N/A	-	X	X	-	Immediately	
<p>Current Condition: At present there are no devices or procedures in place to record water usage associated with the irrigation of cannabis and domestic use.</p>						<p>Prescribed Action: Water metering devices, or procedures for the well, shall be installed to record all water diverted, pumped, and used water for the irrigation of cannabis and domestic use. Water meter(s) and water supply infrastructure shall be designed/installed in a manner such that water usage for the irrigation of cannabis can be recorded separately from water used for domestic use. Additionally, if there are multiple sources of water, infrastructure/metering device(s) shall be design/installed in a manner that each source of water is recorded separately. Monthly water usage shall be recorded for annual reporting purposes. Also, water storage tank lids shall be appropriately closed to prevent the access of wildlife and, if not currently implemented, water conservation measures such as drip line irrigation, morning or evening watering, and mulch or cover cropping of cultivated top soils shall also be implemented.</p>	
Unique Point	Lat-Long NAD 83	Road Type	Mitigation Planned	Monitor	1600	Treatment Priority	Date Completed
Liquid Petroleum Products	N/A	-	X	X	-	Immediately	
<p>Current Condition: All liquid petroleum products (e.g. any size container of any petroleum product) requires secondary containment while not in immediate use and cover from precipitation during the wet season. Adequate quantities of absorbent materials shall also be stored at all locations where these types of materials are used and stored.</p>						<p>Prescribed Action: Any/all liquid petroleum products and their containers shall be stored in secondary containment (e.g. plastic totes or sealed metal boxes) while being stored long term or not in immediate use, wherever these materials are used anywhere on the property. Adequate quantities of absorbent materials (e.g. purpose made materials for oil and fuel spills, cat litter) shall be stored at all locations where these types of materials are used and stored. Should a spill of these materials occur, absorbent materials will be applied immediately and allowed enough time to absorb as much material as possible. Following treatment, absorbent materials applied as well as any contaminated soil will be removed and disposed of appropriately for the spilled material. See attached BMPs: Generator, Fuel, and Oil Management for further details.</p>	



SMP - Mitigation Report

WDID# - 1_12CC417900

Unique Point	Lat-Long NAD 83	Road Type	Mitigation Planned	Monitor	1600	Treatment Priority	Date Completed
Generators and Gas Powered	N/A	-	X	X	-	Immediately	
<p>Current Condition: All liquid petroleum powered generators and pumps require secondary containment, and cover from precipitation during the wet season. Adequate quantities of absorbent materials shall also be stored at all locations where the generators and gas powered pumps are used and stored.</p>						<p>Prescribed Action: Any/all liquid petroleum powered generators or pumps (large or small) shall be stored in secondary containment (e.g. plastic totes, sealed metal boxes, drip pans, pre-fabricated portable containment berms or fabricated and lined containment basins) while being stored long term or not in immediate use, wherever these materials are used anywhere on the property. Adequate quantities of absorbent materials shall be stored at all locations where these types of materials are used and stored. Should a spill of these materials occur, absorbent materials will be applied immediately and allowed enough time to absorb as much material as possible. Following treatment, absorbent materials applied as well as any contaminated soil will be removed and disposed of appropriately for the spilled material. See attached BMPs: Generator, Fuel, and Oil Management for further details.</p>	

WDID: _____

Date: _____

Monthly Water Tracking



Month	Total Surface Water Diversion	Water input to Storage by Source	Water use by Source
January			
February			
March			
April			
May			
June			
July			
August			
September			
October			
November			
December			

WDID: _____

Date: _____

Monthly Water Tracking



BMP: Generator, Fuel, and Oil Management

All bulk fuel storage or petroleum products, any/all future petroleum products and other liquid chemicals, including but not limited to diesel, biodiesel, gasoline, and oils shall be stored so as to prevent their spillage, discharge, or seepage into receiving waters. Storage tanks and containers shall be of suitable material and construction to be compatible with the substance(s) stored and conditions of storage such as pressure and temperature. Above ground storage tanks and containers shall be provided with a secondary means of containment for the entire capacity of the largest single container and sufficient cover shall be provided to prevent any/all precipitation from entering said secondary containment vessel.

If the volume of a fuel container is greater than 1,320 gallons, a Spill Prevention, Control, and Countermeasures (SPCC) plan will be required for the use the fuel tank.

On-site storage of petroleum products, or other fuels used for commercial activities may require registration as hazardous materials through the California Environmental Reporting System (CERS). Additionally, the waste oil generated from commercial activities (generators) and their used oil filters are considered hazardous waste and requires additional reporting. The discharger is advised to contact local agencies to find out if such reporting is applicable to currently operations

Used motor oil is recommended to be stored in sealed containers that the oil was originally packaged in, e.g. sealed buckets/quart or gallon jugs, or other sealed containers designed to store motor oil. Stored used oil is recommended to be regularly disposed of at hazardous waste disposal sites. Used oil filters are also recommended to be stored in sealed containers, e.g. sealed plastic totes/buckets, for later disposal at a hazardous waste disposal site. These storage containers are recommended to be stored in structures where they are protected from precipitation.

Further information regarding the State of California's requirements for the managing of Used Oil and Oil Filters can be found by entering the links below or searching the corresponding titles to the links.

California Department of Toxic Substances Control - Used Oil Generator Requirements

- <https://www.dtsc.ca.gov/InformationResources/upload/RAG-UsedOilforGenerators.pdf>

Department of Toxic Substances Control - Managing Used Oil Filters for Generator

- https://www.dtsc.ca.gov/InformationResources/upload/RAG_Used-Oil-Filters_Generators1.pdf

BMP: Generator, Fuel, and Oil Management (Generators and Pumps)

All generators and petroleum powered pumps shall have spill trays or secondary containment placed underneath them when using, fueling, or changing oil on them to prevent the potential for leeching, seepage or spillage of petroleum products. All spill trays and containment structures require cover from precipitation if used or left out over the winter period. All generators and petroleum powered pump locations shall have spill cleanup kits on hand.

Pre-fabricated secondary containment structures and spill trays can be purchased online or from local wholesalers of petroleum products. As an alternative to pre-fabricated secondary containment structures, structures can be constructed from wooden, cinderblock, concrete, or metal frames lined with PVC liners, e.g. pond liner/water bladder material, as long as the containment is fully sealed and constructed in a similar manner to examples of pre-fabricated containment structures found below. Ensure that diked areas are sufficiently impervious to contain discharged chemicals. All containment structures require cover from precipitation to prevent the containment from filling with water. Secondary containment for fuel tanks shall not be constructed.

As an alternative to pre-fabricated spill kits, kits can consist of sealed trashcans or buckets with industrial absorbent material (e.g. cat litter) and shovels, placed nearby any location where generators, pumps, or other petroleum products or chemicals are used.

Examples of industry standard pre-fabricated spill containment and clean-up kits can be found following or entering the links below. Pre-fabricated spill containment and clean-up kits can be purchased online, from Renner Petroleum, or other similar industry providers.

Ultratech Spill Containment

- <http://www.spillcontainment.com/categories/spill-containment/>

New Pig Portable and Collapsible Spill Containment

- <https://www.newpig.com/collapsible-berms/c/5142?show=All>

BMP: Generator, Fuel, and Oil Management



Example of a small, portable, and compact containment berm.



Example of a portable utility spill tray.

BMP: Generator, Fuel, and Oil Management



Example of secondary containment for a fuel tank. This container requires cover from precipitation.



Example of spill pallets for unused or used oil drums and other petroleum products.

BMP: Winterization and Interim Treatments for Erosion Control

• **Roads**

- Existing or newly installed road surface drainage structures such as water bars, rolling dips, ditch relief culverts, and intentionally in/out-sloped segments of road shall be maintained to ensure continued function of capturing and draining surface runoff.
- Hand tool kick-outs (lead out ditch) for existing wheel rut, surface run-off confinement.
- Temporary waterbar/cross-wattles installed on road/trail sections of concentrating surface runoff.
- Clean existing ditch relief culvert inlets, outlets, and contributing ditch lines of current and potential blockage debris by hand.
- Hand place energy dissipating rock/small woody debris at ditch relief culvert outlets where erosion is occurring.
- Wattles/straw bales placed at road runoff delivery sites.
- Touch-up with hand tools of existing surface drainage structures (kick-outs, rolling dips, and waterbars).
- Seed and straw un-used, or to be abandoned, road surfaces where erosion is occurring.
- Frequent use of un-surfaced roads should be avoided, particularly when road surfaces are soft/saturated.

• **Crossings**

- Clean inlets, outlets, and channels above of current and potential blockage debris by hand.
- Hand place energy dissipating rock/small woody debris at ditch relief culvert outlets.
- Hand placement of rock armor around culvert inlets.
- Install staked wattles along the outboard road edge of out-sloped watercourse crossings where direct delivery of road surface runoff is occurring.
- Hand placement of rock on crossing fill faces where erosion is/may occur as a result of poor crossing construction.

• **Cultivation Areas**

- Use hand tools to capture cultivation related soils that are not contained (soil from post-harvest plant removal, soil/planter removal, general spillage).
- Treat beds, pots, new soil storage piles, spent soil piles, and soil disposal piles with cover crops for soil stability and potentially nitrogen fixing/soil amendment.
- Bagged potting soil should be covered.
- Install staked wattles or an earthen berm around cultivation soils piles prior to the winter period, annually.
- Any soil amendment, fertilizer, herbicide, or pesticide that is not 100% sealed should be stored under cover.
- Cultivation sites with poor or concentrating drainage can have wattles or bales installed prior to winter to help prevent sediment and nutrients from leaving the site.
- Plastic netting shall be disposed of or stored where it is inaccessible to wildlife.
- Tarps/dep covers shall be stored so they cannot be blown away.
- General waste from growing season gathered up and disposed of.
- Exposed soil surfaces in the cultivation area, as well as graded fill slopes should be seeded, strawed, mulched, jute netted as needed.

• **General Areas**

- Remove all refuse prior to leaving property for the season.
- Back fill pit toilets to be abandoned.

BMP: General Recommendations

- **Fertilizers, soil amendments, and pesticides**
 - Fertilizer, soil amendments, and pesticide use it to be recorded in such a manner that cumulative annual totals are recorded for annual reporting.
 - Store in-use fertilizers in a securable storage container, such as a tote or deck box, adjacent to the mixing tanks.

- **Petroleum products and hazardous materials**
 - Utilize spill trays/containment structures and cover over the containment when using, fueling, changing oil on portable generators or petroleum powered water pumps to prevent the potential for leeching, seepage or spillage of petroleum products.
 - It is recommended that all petroleum products and other chemicals are registered with the California Environmental Reporting System (CERS) to satisfy future licensing requirements.

- **Water storage and Use**
 - Water use shall be designed and metered such that water used for the irrigation of cannabis will be recorded separately from domestic use. Water use for the irrigation of cannabis is to be recorded monthly for annual reporting.
 - Ensure lids are secured on all water storage tanks to prevent wildlife from becoming entrapped within the tank.
 - Install float valves, or implement another equivalent system, on all applicable water storage and transfer tanks to prevent unnecessary water diversion and the overflowing of water tanks.

BMP: General Operations BMPs

- If operations require moving of equipment across a flowing stream, such operations shall be conducted without causing a prolonged visible increase in stream turbidity. For repeated crossings, the operator shall install a bridge, culvert, or rock-lined crossing.
- During construction in flowing water, which can transport sediment downstream, the flow shall be diverted around the work area by pipe, pumping, temporary diversion channel or other suitable means. When any dam or artificial obstruction is being constructed, maintained, or placed in operation, sufficient water shall at all times be allowed to pass downstream to maintain fish life below the dam. Equipment may be operated in the channel of flowing live streams only as necessary to construct the described construction.
- Disturbance or removal of vegetation shall not exceed the minimum necessary to complete operations. The disturbed portion of any stream channel shall be restored to as near their original condition as possible. Restoration shall include the mulching of stripped or exposed dirt areas at crossing sites prior to the end of the work period.
- Structures and associated materials not designed to withstand high seasonal flow shall be removed to areas above the high-water mark before such flows occur.
- No debris, soil, silt, sand, bark, slash, sawdust, rubbish, cement or concrete washing, oil or petroleum products, or other organic or earthen material from any logging, construction, or associated activity of whatever nature shall be allowed to enter into or be placed where it may be washed by rainfall or runoff into waters of the State. When operations are completed, any excess materials or debris shall be removed from the work area. No rubbish shall be deposited within 150 feet of the high-water mark of any stream.

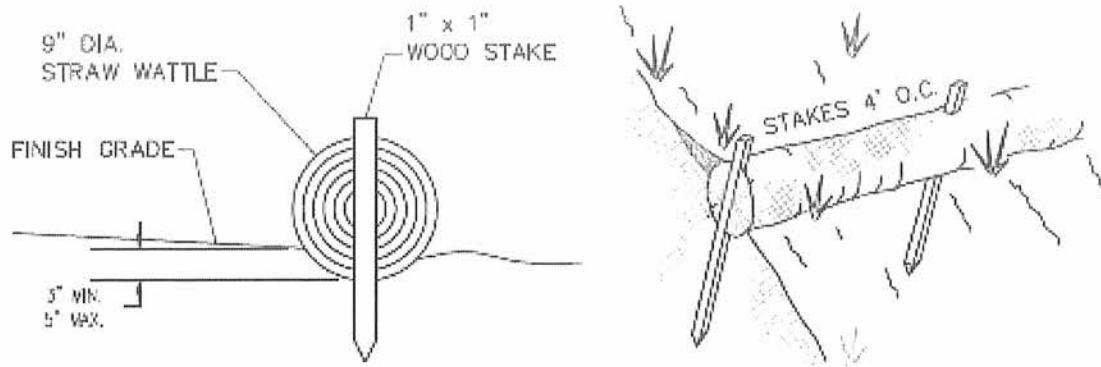
BMP: General Erosion Control

- Timing for soil stabilization measures within the 100 feet of a watercourse or lake: For areas disturbed from May 1 through October 15, treatment shall be completed prior to the start of any rain that causes overland flow across or along the disturbed surface. For areas disturbed from October 16 through April 30, treatment shall be completed prior to any day for which a chance of rain of 30 percent or greater is forecast by the National Weather Service or within 10 days, whichever is earlier.
- Within 100 feet of a watercourse or lake, the traveled surface of logging roads shall be treated to prevent waterborne transport of sediment and concentration of runoff that results from operations. Treatment may consist of, but not limited to, rocking, out sloping, rolling dips, cross drains, water bars, slope stabilization measures, or other practices appropriate to site-specific conditions.
- The treatment for other disturbed areas within 100 feet of a watercourse or lake, including: (A) areas exceeding 100 contiguous square feet where operations have exposed bare soil, (B) approaches to road watercourse crossings out to 100 feet or the nearest drainage facility, whichever is farthest, (C) road cut banks and fills, and (D) any other area of disturbed soil that threatens to discharge sediment into waters in amounts deleterious to the quality and beneficial uses of water, shall be grass seeded and mulched with straw or fine slash. Grass seed shall be applied at a rate exceeding 100 pounds per acre. Straw mulch shall be applied in amounts sufficient to provide at least 2- 4-inch depth of straw with minimum 90% coverage. Slash may be substituted for straw mulch provided the depth, texture, and ground contact are equivalent to at least 2 – 4 inches of straw mulch. Any treated area that has been subject to reuse or has less than 90% surface cover shall be treated again prior to the end of operations.
- Within 100 feet of a watercourse or lake, where the undisturbed natural ground cover cannot effectively protect beneficial uses of water from operations, the ground shall be treated with slope stabilization measures described in #3 above per timing described in #1 above.
- Side cast or fill material extending more than 20 feet in slope distance from the outside edge of a landing which has access to a watercourse or lake shall be treated with slope stabilization measures described in #3 above. Timing shall occur per #1 above unless outside 100 feet of a watercourse or lake, in which completion date is October 15.
- All roads shall have drainage and/or drainage collection and storage facilities installed as soon as practical following operations and prior to either (1) the start of any rain which causes overland flow across or along the disturbed surface within 100 feet of a watercourse or lake protection, or (2) any day with a National Weather Service forecast of a chance of rain of 30 percent or more, a flash flood warning, or a flash flood watch.

BMP: General Erosion Control (Cont.)

- Erosion control and sediment detention devices and materials shall be incorporated into the cleanup/restoration work design and installed prior to the end of project work and before the beginning of the rainy season. Any continuing, approved project work conducted after October 15 shall have erosion control works completed up-to-date and daily.
- Erosion control materials shall be, at minimum, stored on-site at all times during approved project work between May 1 and October 15.
- Approved project work within the 5-year flood plain shall not begin until all temporary erosion controls (straw bales or silt fences that are effectively keyed-in) are installed downslope of cleanup/restoration activities.
- Non-invasive, non-persistent grass species (e.g., barley grass) may be used for their temporary erosion control benefits to stabilize disturbed slopes and prevent exposure of disturbed soils to rainfall.
- Upon work completion, all exposed soil present in and around the cleanup/restoration sites shall be stabilized within 7 days.
- Soils exposed by cleanup/restoration operations shall be seeded and mulched to prevent sediment runoff and transport.
- Straw Wattles (if used) shall be installed with 18 or 24-inch wood stakes at four feet on center. The ends of adjacent straw wattles shall be abutted to each other snugly or overlapped by six inches. Wattles shall be installed so that the wattle is in firm contact with the ground surface.

BMP: General Erosion Control (Cont.)

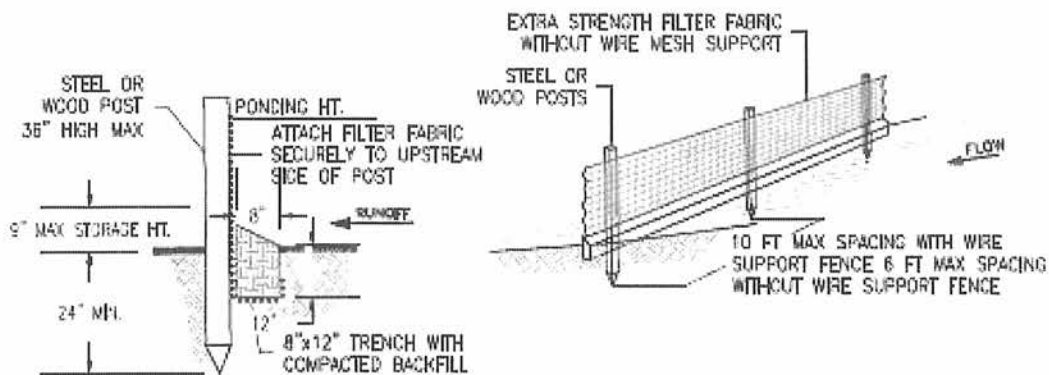


STRAW WATTLE NOTES:

1. STRAW WATTLES SHALL BE INSTALLED WITH 18 OR 24 INCH WOOD STAKES AT FOUR FEET ON CENTER. THE ENDS OF ADJACENT STRAW WATTLES SHALL BE ADJUSTED TO EACH OTHER SNUGLY OR OVERLAPPED BY SIX INCHES.
2. STRAW ROLL INSTALLATION REQUIRES THE PLACEMENT AND SECURE STAKING OF THE ROLL IN A TRENCH, 3"-5" DEEP. RUNOFF MUST NOT BE ALLOWED TO RUN UNDER OR AROUND THE ROLL.

STRAW WATTLE INSTALLATION DETAIL

NTS



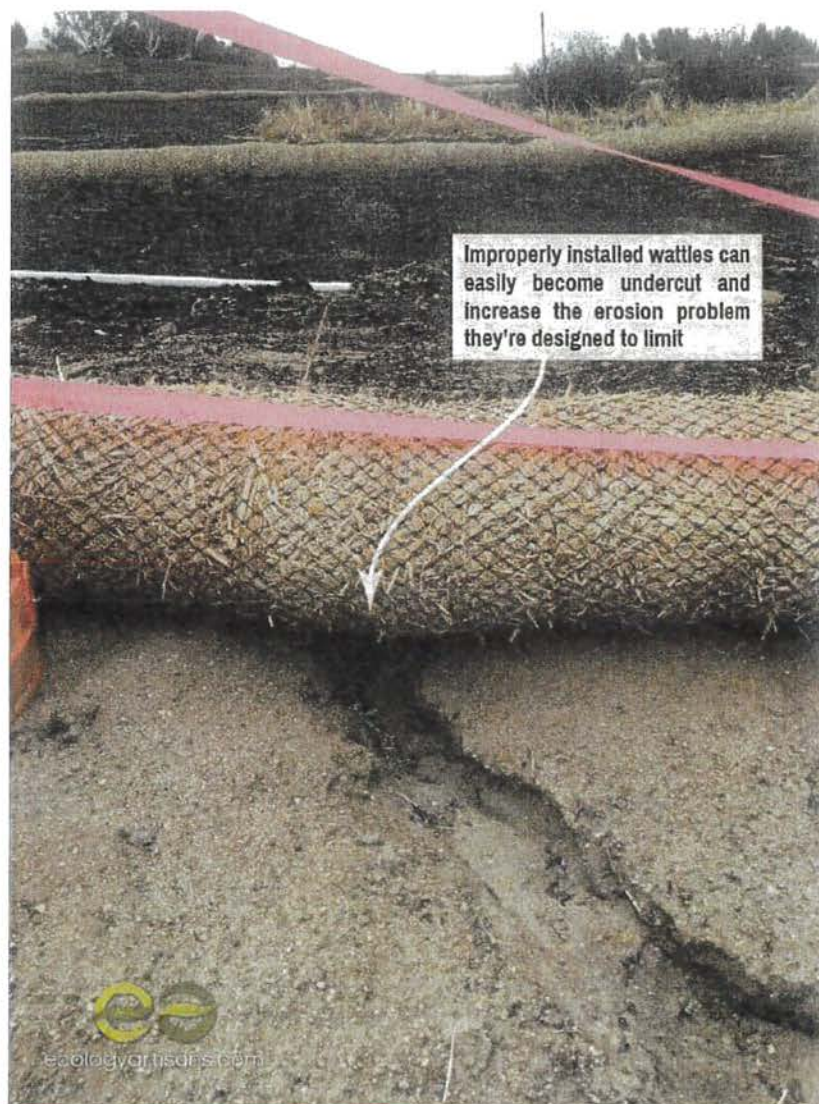
SILT FENCE NOTES:

1. THE CONTRACTOR SHALL INSPECT AND REPAIR FENCE AFTER EACH STORM EVENT
2. CONTRACTOR SHALL REMOVE SEDIMENT AS NECESSARY. REMOVED SEDIMENT SHALL BE DEPOSITED TO AN AREA THAT WILL NOT CONTRIBUTE SEDIMENT OFF-SITE AND IN AN AREA THAT CAN BE PERMANENTLY STABILIZED.
3. SILT FENCE SHALL BE PLACED ON SLOPE CONTOURS TO MAXIMIZE PONDING EFFICIENCY.

SILT FENCE DETAILS

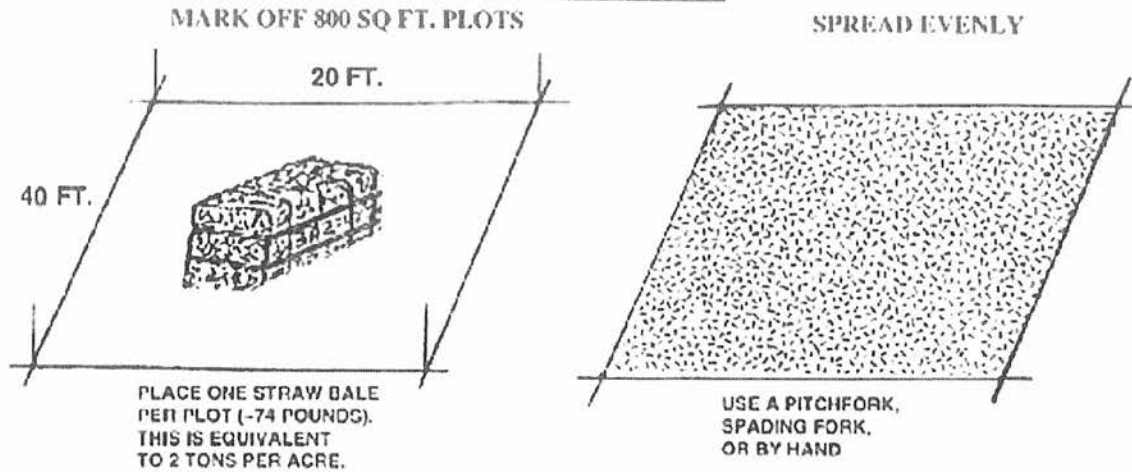
NTS

BMP: General Erosion Control (Cont.)

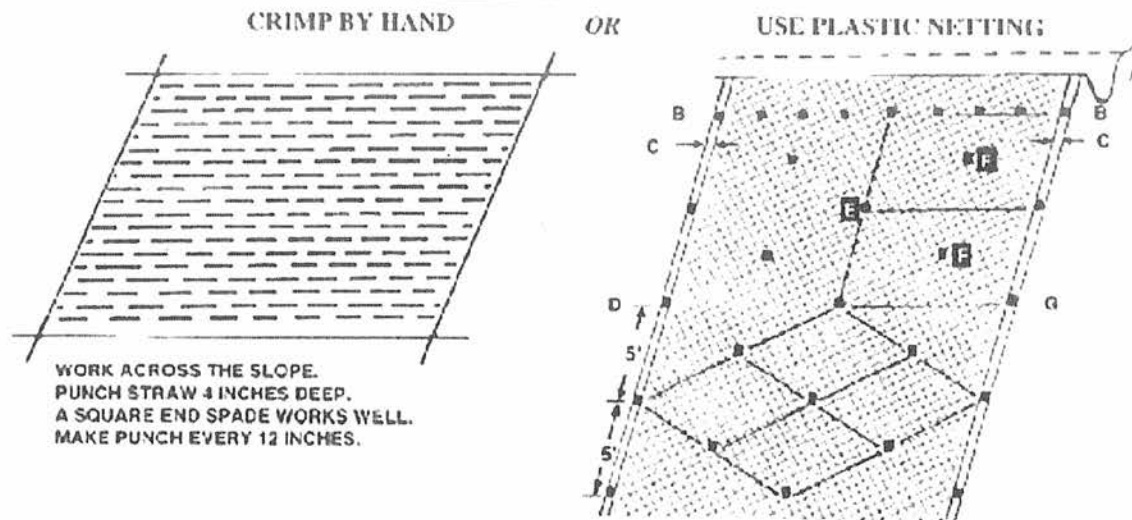


BMP: General Erosion Control (Cont.)

SPREAD THE STRAW



ANCHOR THE STRAW

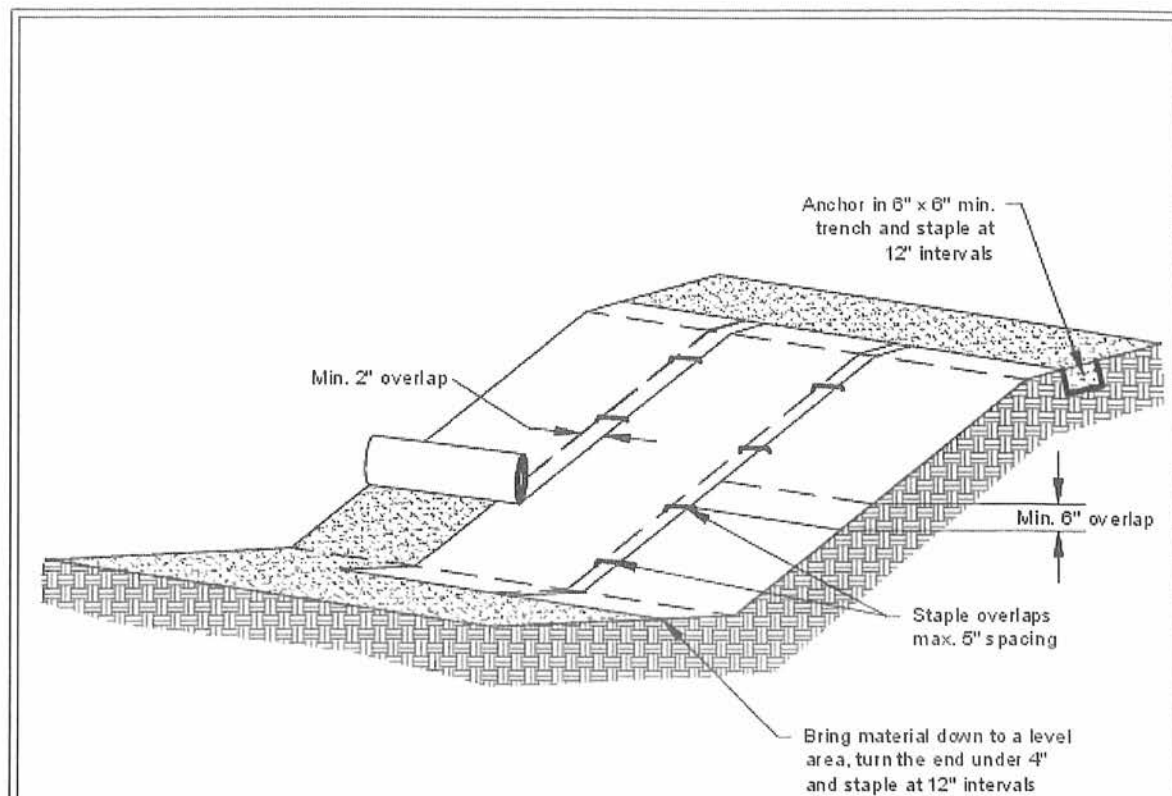


- A. LAY BIRD CONTROL NETTING OR SIMILAR MATTING IN STRIPS DOWN THE SLOPE OVER THE STRAW. BURY UPPER END IN 6-8 INCH DEEP AND WIDE TRENCH.. MOST NETTING COMES IN 14 TO 17 FT. WIDE ROLLS.
- B. SECURE THE UPPER END WITH STAKES EVERY 2 FEET.
- C. OVERLAP SEAMS ON EACH SIDE 4-5 INCHES.
- D. SECURE SEAMS WITH STAKES EVERY 5 FEET.
- E. STAKE DOWN THE CENTER EVERY 5 FEET.

- F. STAKE MIDDLES TO CREATE DIAMOND PATTERN THAT PROVIDES STAKES SPACED 4-5 FEET APART.
- G. USE POINTED 1X2 INCH STAKES 8 TO 9 INCHES LONG. LEAVE 1 TO 2 INCH TOP ABOVE NETTING, OR USE "U" SHAPED METAL PINS AT LEAST 9 INCHES LONG.

NOTE: WHEN JOINING TWO STRIPS, OVERLAP UPPER STRIP 3 FEET OVER LOWER STRIP AND SECURE WITH STAKES EVERY 2 FEET LIKE IN "B" ABOVE

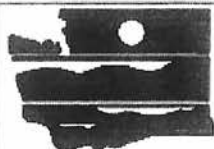
BMP: General Erosion Control (Cont.)



Notes:

1. Slope surface shall be smooth before placement for proper soil contact.
2. Stapling pattern as per manufacturer's recommendations.
3. Do not stretch blankets/matting tight - allow the rolls to mold to any irregularities.
4. For slopes less than 3H:1V, rolls may be placed in horizontal strips.
5. If there is a berm at the top of the slope, anchor upslope of the berm.
6. Lime, fertilize, and seed before installation. Planting of shrubs, trees, etc. should occur after installation.

NOT TO SCALE



DEPARTMENT OF
ECOLOGY
State of Washington

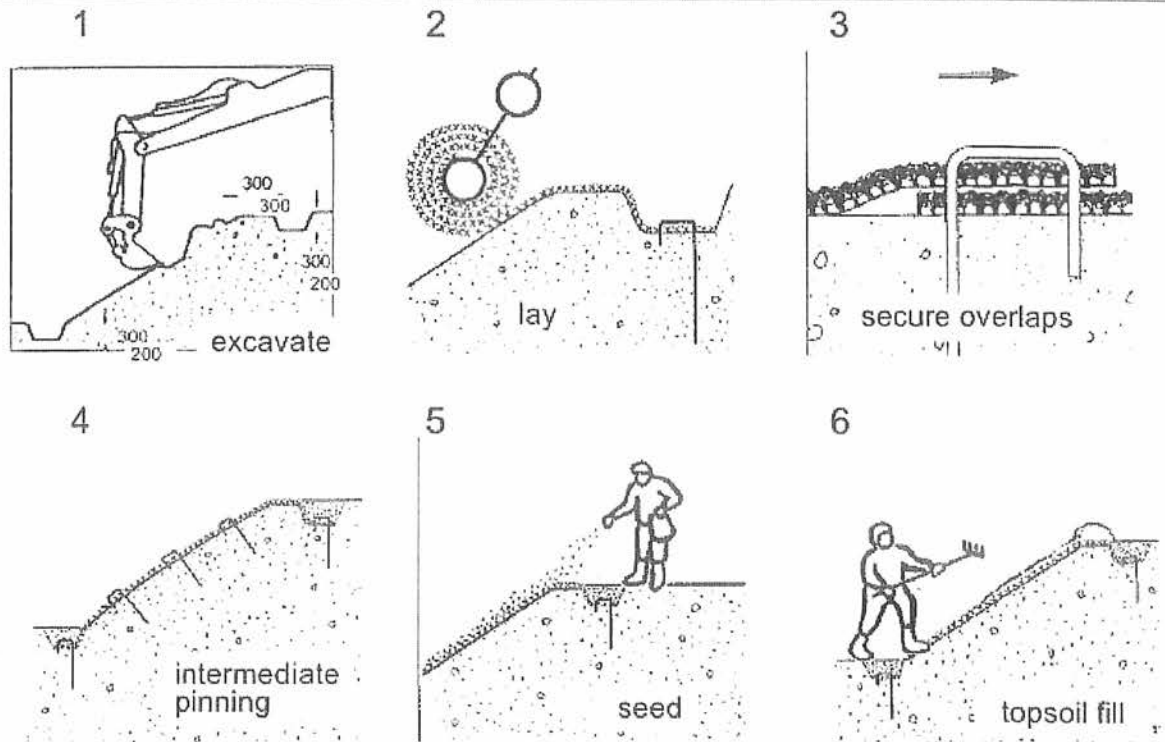
Slope Installation

Revised June 2016

Please see <http://www.ecy.wa.gov/copyright.html> for copyright notice including permissions, limitation of liability, and disclaimer.

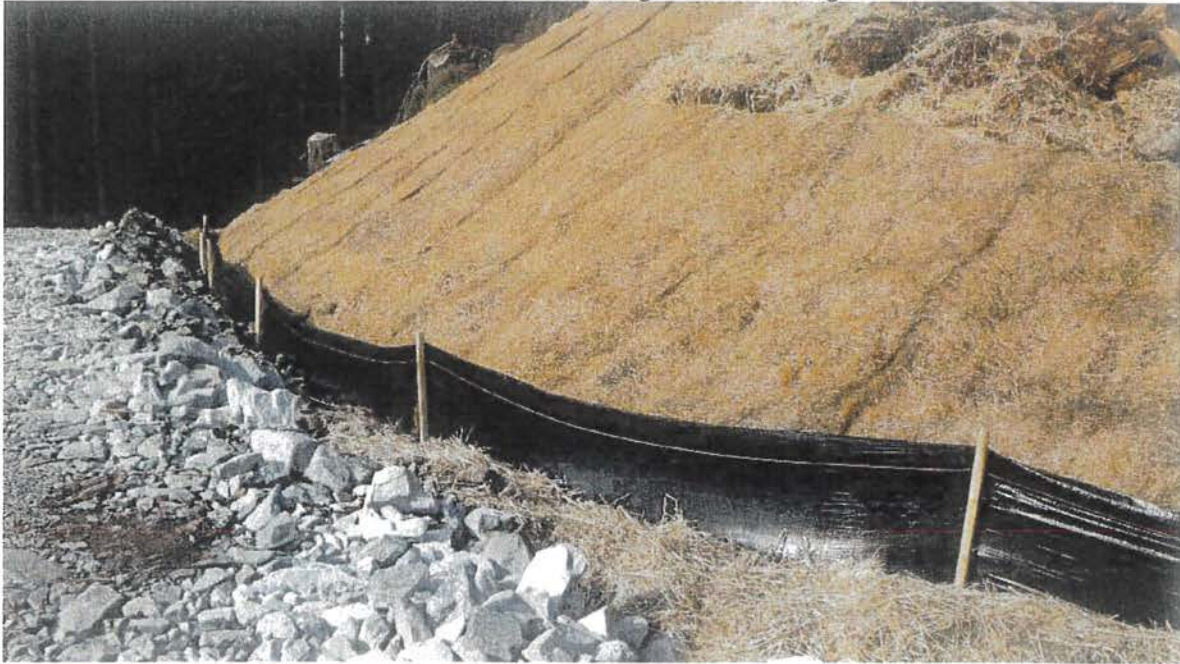
BMP: General Erosion Control (Cont.)

Installation of a geosynthetics mat - Enkamat



Erosion Control Measures (Cont.)

Erosion Control Matting & Silt Fencing



Jute netting & Straw-wattles



BMP: General Erosion Control (Cont.)

TABLE 34. Guidelines for erosion and sediment control application

Timing of application	Technique	Portion of road and construction area treated
Erosion control during construction	Hydromulching, hydroseeding	Road fill slopes, cut slopes, bare soil areas
	Dry seeding	Road fill slopes, cut slopes, bare soil areas
	Wood chip, straw, Excelsior or tackified mulch	Road fill slopes, cut slopes, bare soil areas
	Straw wattles	Road fill slopes and cut slopes
	Gravel surfacing	Road, landing and turnout surfaces
	Dust palliative	Road surfaces
	Minimize disturbance (soil and vegetation)	All areas peripheral to construction
Sediment control during construction	Sediment basin	Roadside ditches, turnouts and small stream crossings
	Sediment traps (e.g., silt fences, straw bales barriers, woody debris barriers)	Road fill slopes, cutbanks, bare soil areas and ditches
	Straw bale dams	Ditches and small streams
	Sumps and water pumps	Stream channels and stream crossings
	Streamflow diversions (e.g., temporary culverts, flex pipe, etc.)	Stream channels and stream crossings
	Surface diversion and dispersion devices (pipes, ditches, etc.)	All disturbed bare soil areas
	Road shaping	Road and landing surfaces
	Gravel surfacing	Road, landing and turnout surfaces
	Bituminous or asphalt surfacing	Road surface
	Rolling dips	Road surface
Permanent erosion control	Ditch relief culverts	Roadbed and road fill
	Downspouts and berm drains	Road fill slopes
	Waterbars	Road and landing surfaces
	Berns	Road surface and roadside areas
	Ditches	Road and landing surfaces
	Riprap	Road fill slopes, stream crossing fills, cutbanks, stream and lake banks
	Soil bioengineering	Road fill slopes, cut slopes, stream crossings, streambanks
	Tree planting	Road fill slopes, cutbanks, bare soil areas, stream crossings, streambanks

HANDBOOK FOR FOREST, RANCH AND RURAL ROADS

BMP: Permanent Culvert Crossing

- New culvert installations shall be sized to accommodate flows associated with a 100-year storm event.
- If the new culvert is replacing a poorly installed old culvert, the crossing may need to be abandoned to the following standard:
 - When fills are removed they shall be excavated to form a channel that is as close as feasible to natural watercourse grade and orientation, and that is wider than the natural channel.
 - Excavated banks shall be laid back to a 2:1 (50%) or natural slope.
- New culverts shall be placed at stream gradient, or have downspouts, or have energy dissipaters at outfall.
 - Align culverts with the natural stream channel orientation to ensure proper function, prevent bank erosion, and minimize debris plugging. See Figure 97 below.
 - Place culverts at the base of the fill and at the grade of the original streambed or install a downspout past the base of the fill. Downspouts should only be installed if there are no other options.
 - Culverts should be set slightly below the original stream grade so that the water drops several inches as it enters the pipe.
 - Culvert beds should be composed of rock-free soil or gravel, evenly distributed under the length of the pipe.
 - Compact the base and sidewall material before placing the pipe in its bed.
 - Lay the pipe on a well-compacted base. Poor basal compaction will cause settling or deflection in the pipe and can result in separation at a coupling or rupture in the pipe wall.
 - Backfill material should be free of rocks, limbs, or other debris that could dent or puncture the pipe or allow water to seep around the pipe.
 - Cover one end of the culvert pipe, then the other end. Once the ends are secure, cover the center.
 - Tamp and compact backfill material throughout the entire process, using water as necessary for compaction.
 - Backfill compacting will be done in 0.5 – 1.0 foot lifts until 1/3 of the diameter of the culvert has been covered.
 - Push layers of fill over the crossing to achieve the final design road grade, road fill above the culvert should be no less than one-third to one-half the culvert diameter at any point on the drivable surface.
- Critical dips shall be installed on culvert crossings to eliminate diversion potential. Refer to Figure 84 below.
- Road approaches to crossings shall be treated out to the first drainage structure (i.e. waterbar, rolling dip, or hydrologic divide) to prevent transport of sediment.
- Road surfaces and ditches shall be disconnected from streams and stream crossings to the greatest extent feasible. Ditches and road surfaces that cannot be feasible disconnected from streams or stream crossings shall be treated to reduce sediment transport to streams.
- If downspouts are used, they shall be secured to the culvert outlet and shall be secure on fill slopes.
- Culverts shall be long enough so that road fill does not extend or slough past the culvert ends.
- Inlet of culverts, and associate fill, shall be protected with appropriate measures that extend at least as high as the top of the culvert.
- Outlet of culverts shall be armored with rock if road fill sloughing into channel can occur.
- Armor inlets and outlets with rock, or mulch and seed with grass as needed (not all stream crossings need to be armored).
- Where debris loads could endanger the crossing, a debris catchment structure shall be constructed upstream of the culvert inlet.
- Bank and channel armoring may occur, when appropriate, to provide channel and bank stabilization.

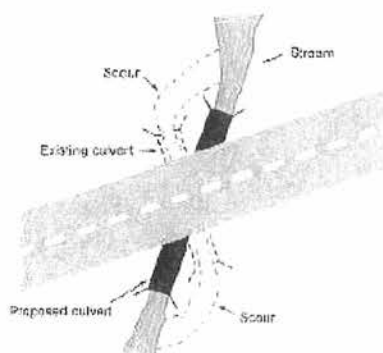


FIGURE 97. *Culvert alignment should be in relation to the stream and not the road. It is important that the stream enters and leaves the culvert in a relatively straight horizontal alignment so streamflow does not have to turn to enter the inlet or discharge into a bank as it exits. This figure shows a redesigned culvert installation that replaces the bending alignment that previously existed. Channel turns at the inlet increase plugging potential because wood going through the turn will not align with the inlet. Similarly, channel turns at the outlet are often accompanied by scour against the channel banks (Wisconsin Transportation Information Center, 2004).*

HANDBOOK FOR FOREST, RANCH AND RURAL ROADS

BMP: Permanent Culvert Crossing Design (Critical Dip and Hydrologic Disconnect Placement)

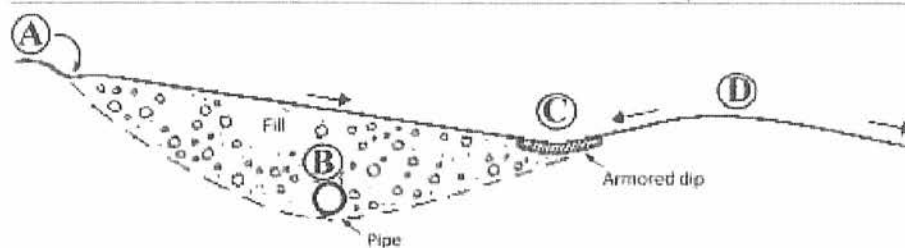
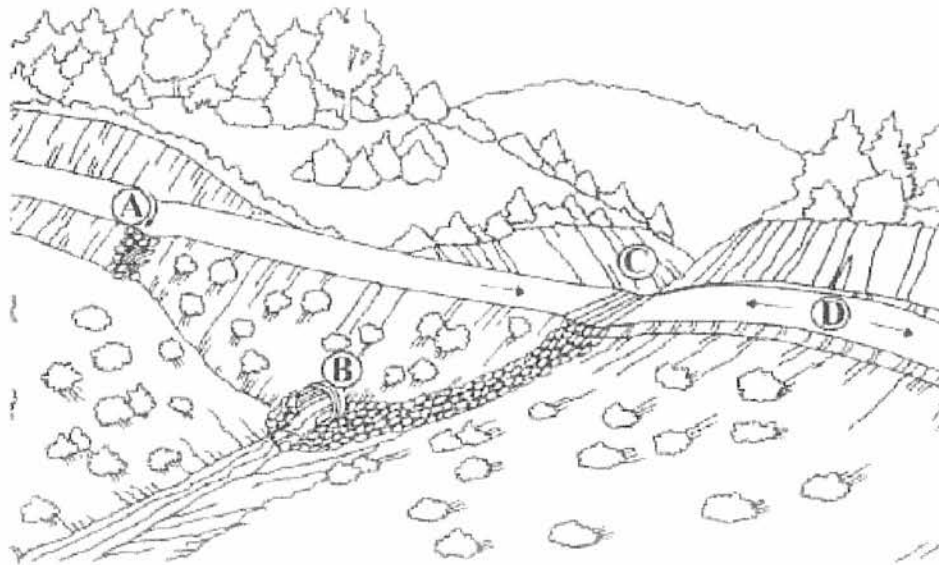
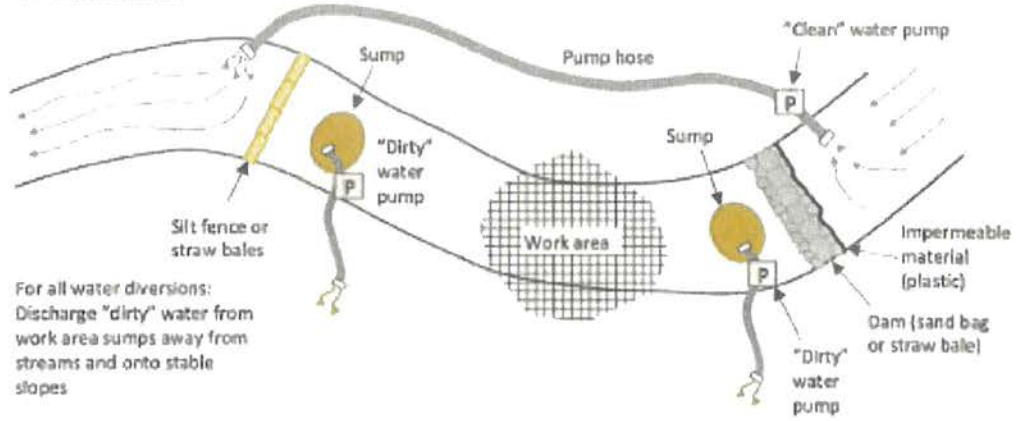


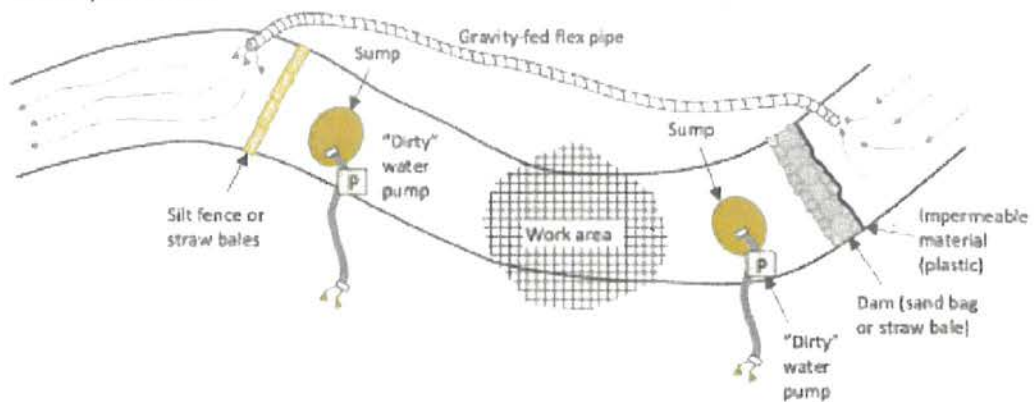
FIGURE 84. Critical dips or dipped crossing fills should be centered near a stream crossing's down-road hinge line, not over the centerline of the crossing where overtopping could cause washout or severe erosion of the fill. If the stream crossing culvert (B) plugs, water will pond behind the fill until reaching the critical dip or low point in the crossing (C) and flowing back down into the natural stream channel. The down-road ditch must be plugged to prevent streamflow from diverting down the ditch line. For extra protection in this sketch, dprap armor has been placed at the critical dip outfall and extending downslope to the stream channel. This is only required or suggested on stream crossings where the culvert is highly likely to plug and the crossing fill overtopped. The dip at the hinge line is usually sufficient to limit erosional damage during an overtopping event. Road surface and ditch runoff is disconnected from the stream crossing by installing a rolling dip and ditch relief culvert just up-road from the crossing (A) (Keller and Sheraz, 2003).

BMP: Permanent Culvert Crossing Design (Cofferdam Construction and Use Specifications)

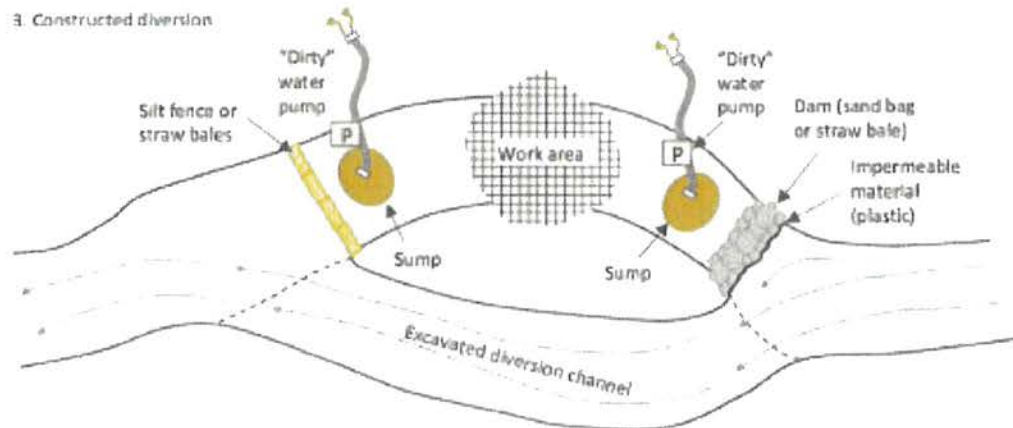
1. Pumped diversion



2. Gravity-fed diversion



3. Constructed diversion



BMP: Permanent Culvert Crossing Design (Cofferdam Construction and Use Specifications)



FIGURE 197. Flex pipe stream diversion around a road construction site. The inlet to this 6 inch diameter flex pipe inlet collects clear streamflow from a retention dam above the project site and gravity feeds it around the project area and back into the natural channel downstream from construction work (see photo).



FIGURE 198. Sand bag retention dam on this small stream was used to pond streamflow so it could be pumped around a culvert installation site. The green intake hose is screened to keep out rocks and debris while the red pump hose extends several hundred feet around the project work area.



FIGURE 199. For larger streams, pump trucks, large pumps or multiple small pumps can be used to pump streamflow around project work sites. Here, a pump truck is used to temporarily divert flow in a fish bearing stream where dual culverts are being replaced with a railcar bridge. Young fish were removed from this fish bearing stream before project work started.

BMP: Permanent Culvert Crossing Design (Culvert Orientation)

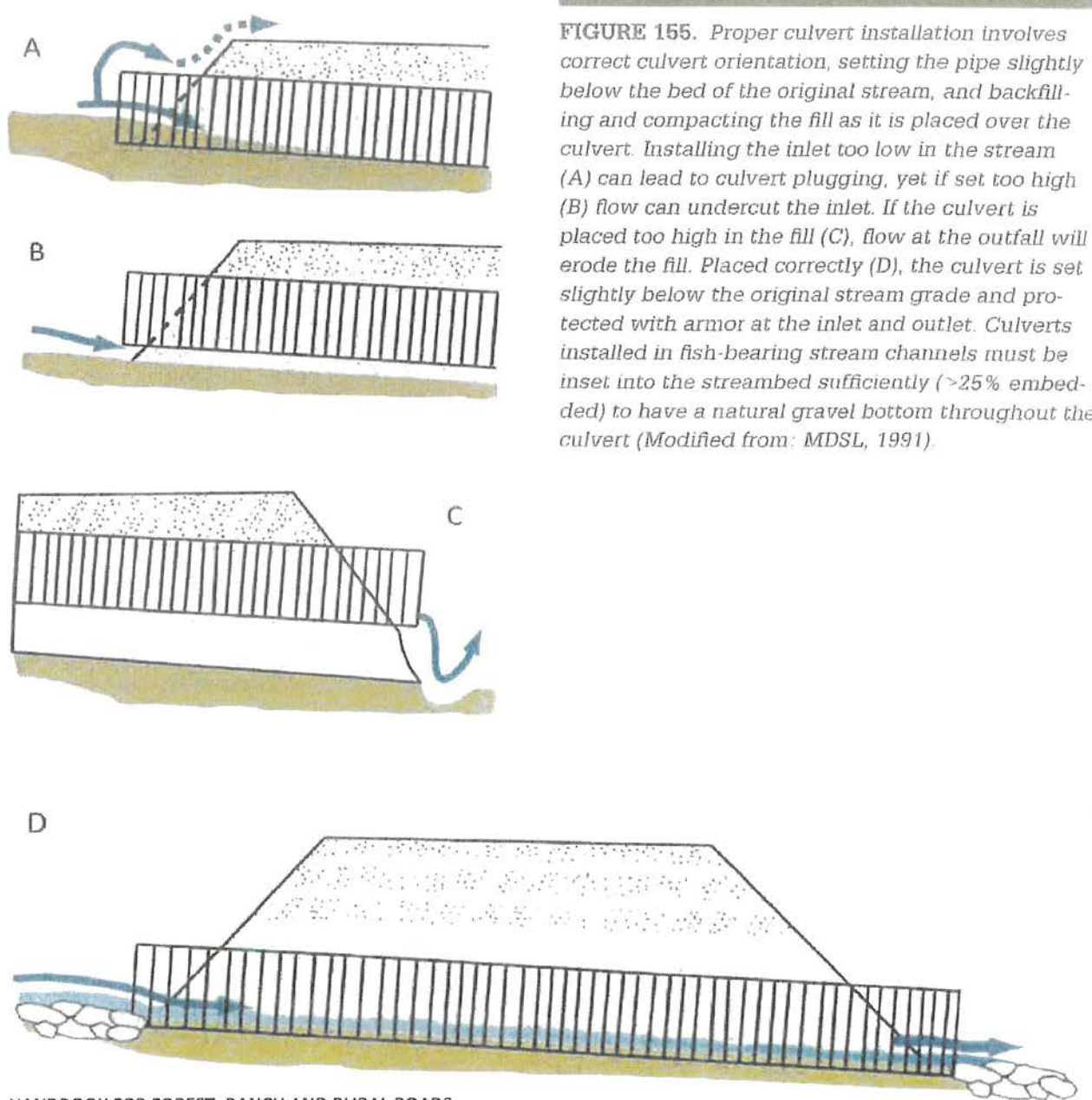
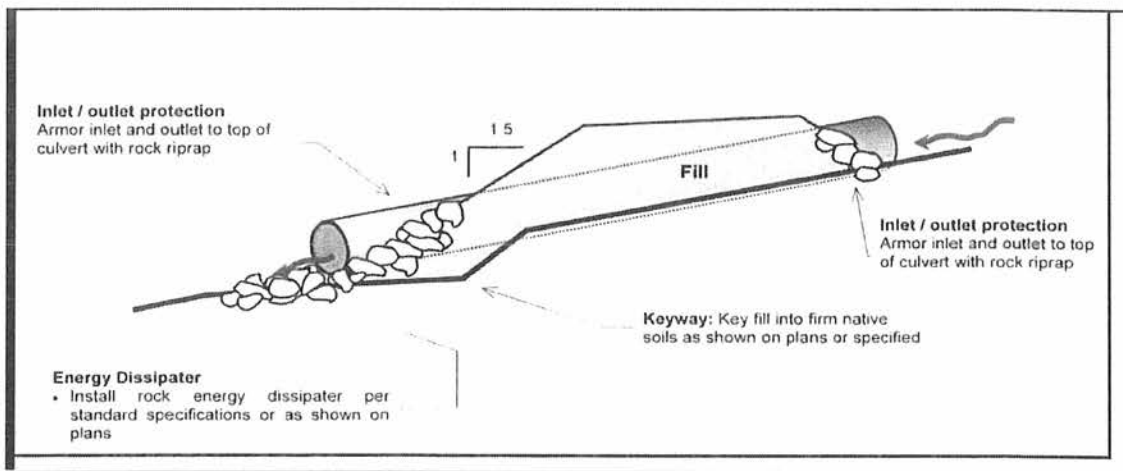
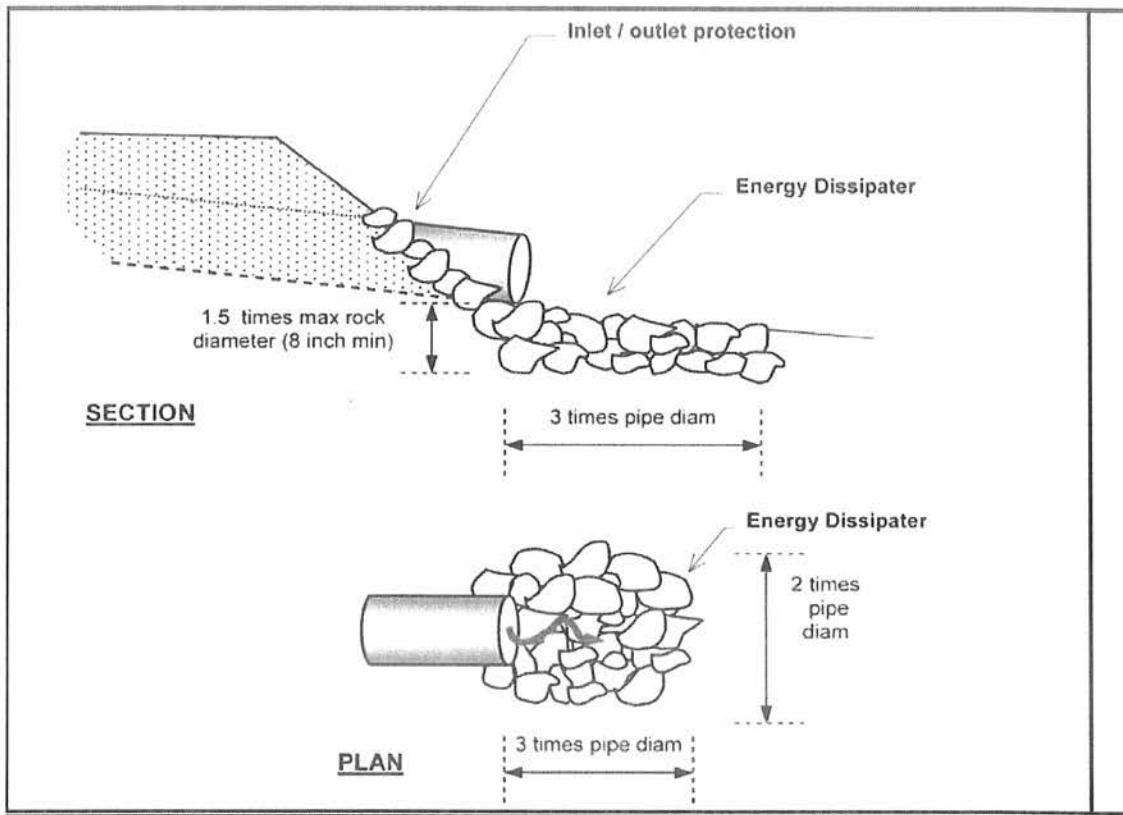


FIGURE 155. Proper culvert installation involves correct culvert orientation, setting the pipe slightly below the bed of the original stream, and backfilling and compacting the fill as it is placed over the culvert. Installing the inlet too low in the stream (A) can lead to culvert plugging, yet if set too high (B) flow can undercut the inlet. If the culvert is placed too high in the fill (C), flow at the outfall will erode the fill. Placed correctly (D), the culvert is set slightly below the original stream grade and protected with armor at the inlet and outlet. Culverts installed in fish-bearing stream channels must be inset into the streambed sufficiently (>25% embedded) to have a natural gravel bottom throughout the culvert (Modified from: MDSL, 1991).

BMP: Permanent Culvert Crossing Design (Inlet and Outlet Armoring)



Riprap installed to protect the inlet and outlet of a stream crossing culvert from erosion or for energy dissipation should be keyed into the natural channel bed and banks to an approximate depth of about 1.5x the maximum rock thickness. Riprap should be placed at least up to the top of the culvert at both the inlet and outlet to protect them from splash erosion and to trap any sediment eroded from the newly constructed fill slope above.

BMP: Permanent Culvert Crossing Design (Inlet and Outlet Armoring) Cont.

- Inlets of culverts and associate fills shall be protected with rock armoring that extends at least as high as the top of the culvert.
- Outlets of culverts shall be provided a rock energy dissipater at the outfall of the culvert.
- Outlets of culverts and associate fills shall be protected with rock armoring that extends at least as high as the top of the culvert if road fill sloughing into channel can occur.
- Prior to inlet and outlet rocking, the inlet and outlets shall be prepared. Preparation will include removal of vegetation and stored materials from the inlet and outlet.
- Inlets may require construction of an inlet basin.
- Slopes at the outlet should be shaped to a 2:1 or natural slope prior to placing rock armor.
- Rock used at culvert inlets and outlets should be a matrix of various sized rocks and rip-rap that range from a 3" dia. to a 2' dia.
- The largest rocks should be places at the base of the culvert or fill. Incrementally smaller rocks shall be placed over the larger rocks at the armoring extend up the slope. Voids and spaces shall be back filled with smaller gravels and rocks.

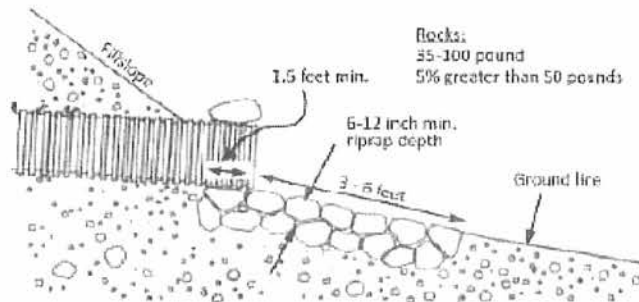


FIGURE 107A. Riprap armor at culvert outlet (Modified from: Keller et al., 2011).



FIGURE 107B. Riprap armor at culvert inlet (Keller and Shear, 2003).

HANDBOOK FOR FOREST, RANCH AND RURAL ROADS

BMP: Stream Bank Armoring (Riprap)

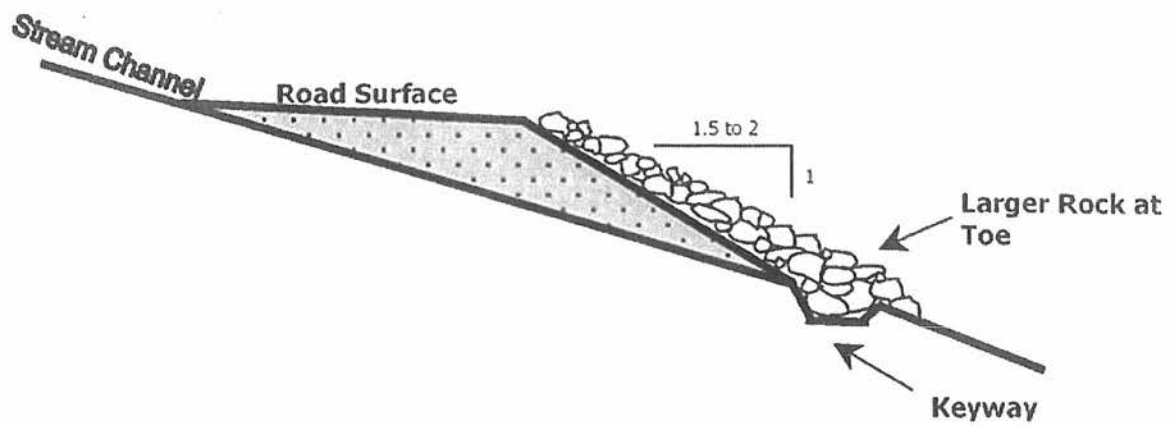
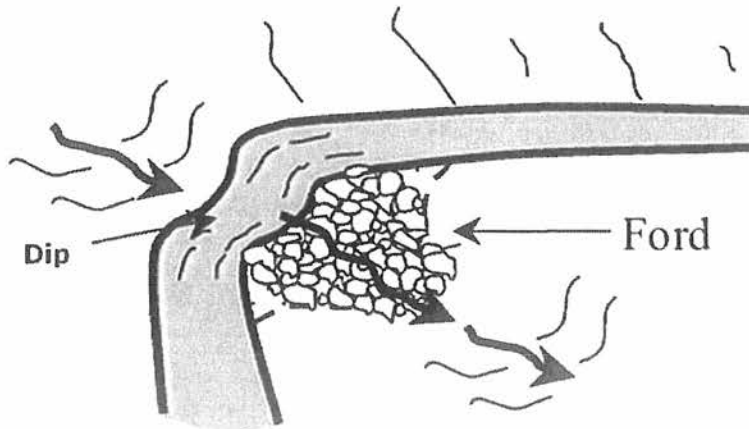
- Riprap should be installed on top of geotextile fabric or a clean mixture of coarse gravel and sand.
- The riprap should be keyed into the streambed and extend below the maximum expected scour depth with an adequately sized key base width at a thickness of a minimum of 2x the median (D50) rock diameter with the largest stone sizes placed at the base of the riprap structure.
- The armor should be set into the streambank so it does not significantly protrude into, or constrict, the natural channel, or otherwise reduce channel capacity.
- The riprap should extend along the length of unstable or over steepened bank and up the bank sufficiently to encompass the existing bank instability and/or design flood elevations.

BMP: Rocked Ford

- Rocked fords are drainage structures designed to carry watercourses across roads where culvert crossings are not feasible or un-necessary.
- In channel constructed fords shall be of appropriate material that shall withstand erosion by expected velocities and placed in a U-shaped channel to create a drivable crossing.
 - The road shall dip into and out of the rocked ford to minimize diversion potential. Construct a broad rolling dip across the roadbed, centered at the crossing, which is large enough to contain the expected 100-yr flood discharge while preventing flood flow from diverting down the road or around the rock armor.
- The road surface at the ford shall be constructed with clean rock. The rock shall be applied to a minimum depth of 6 inches.
 - A range of interlocking rock armor sizes should be selected and sized so that peak flows will not pluck or transport the armor off the roadbed or the sloping fill face of the armored fill.
- The ford's outlet shall be rock armored to resist downcutting and erosion.
 - *Excavate the keyway and armored area* - Excavate a two to three-foot-deep "bed" into the dipped road surface and adjacent fillslope (to place the rock in) that extends from approximately the middle of the road, across the outer half of the road, and down the outboard road fill to where the base of the fill meets the natural channel. At the base of the fill, excavate a keyway trench extending across the channel bed.
 - *Armor the basal keyway* - Put aside the largest rock armoring to create the buttresses. Use the largest rock armor to fill the basal trench and create a buttress at the base of the fill. This should have a "U" shape to it and it will define the outlet where flow leaves the armored fill and enters the natural channel.
 - *Armor the fill* - Backfill the fill face with the remaining rock armor making sure the final armor is unsorted and well placed, the armor is two coarse-rock layers in thickness, and the armored area on the fill face also has a "U" shape that will accommodate the largest expected flow.
 - *Armor the top of the fill* - Install a second trenched buttress for large rock at the break-in-slope between the outboard road edge and the top of the fill face.
- If water is expected during the time of use, an adequately sized pipe shall be installed to handle the flow if present (min. 6 inch).
 - The pipe shall be laid over the rocked ford surface.
 - The inlet should be at grade with the upstream flow.
 - The outlet shall drain onto the outlet armoring of the rocked ford.
 - A layer of clean rock/gravel shall be installed over the pipe to establish the running surface of the truck road.
 - Following use, the temporary pipe shall be removed and the placed rock/gravel shall be graded out of the ford and used on the approaches.
 - No significant alteration to the bed and bank of the stream shall occur.
- Road approaches to rocked fords shall be rock surfaced out to the first drainage structure (i.e. waterbar) or hydrologic divide to prevent transport of sediment using rock.
- Bank and channel armoring may occur when appropriate to provide channel and bank stabilization.
- Road approach rock and rock ford armoring shall be reapplied following use as needed to maintain a permanent crossing.

BMP: Rocked Ford (Cont.)

FORD: A large dip is graded into the road at the axis of the stream channel. The outside fill face is dished out to form a spillway with large rock. On large watercourses, rock is keyed several feet into firm native soils. The road surface is rocked with 6" of minus rock .



BMP: Armored Ford (Fill)

- Armored fords are drainage structures designed to carry watercourses across roads.
- Armored fords shall have a U-shaped channel to create a drivable crossing.
 - The road shall dip into and out of the armored ford to minimize diversion potential. Construct a broad rolling dip across the roadbed, centered at the crossing, which is large enough to contain the expected 100-yr flood discharge while preventing flood flow from diverting down the road or around the rock armor.
- The road surface at the armored ford shall utilize native soils.
- The ford's inlet shall be rocked if a threat of head cutting exists.
 - *Excavate the keyway* - Excavate a one to three-foot-deep "bed" into the inboard edge of the road
 - *Armor the basal keyway* – place various sized rock in the constructed keyway to prevent head cutting. Use the largest rock armor to fill the keyway trench and create a buttress along the inboard edge of the road. This should have a "U" shape to it and it will define the inlet where flow leaves the natural channel and enters the road.
- The ford's outlet shall be rock armored to resist downcutting and erosion.
 - *Excavate the keyway and armored area* - Excavate a two to three-foot-deep "bed" into the dipped road surface and adjacent fillslope (to place the rock in) that extends from approximately the middle of the road, across the outer half of the road, and down the outboard road fill to where the base of the fill meets the natural channel. At the base of the fill, excavate a keyway trench extending across the channel bed.
 - *Armor the basal keyway* - Put aside the largest rock armoring to create the buttresses. Use the largest rock armor to fill the basal trench and create a buttress at the base of the fill. This should have a "U" shape to it and it will define the outlet where flow leaves the armored fill and enters the natural channel.
 - *Armor the fill* - Backfill the fill face with the remaining rock armor making sure the final armor is unsorted and well placed, the armor is two coarse-rock layers in thickness, and the armored area on the fill face also has a "U" shape that will accommodate the largest expected flow.
 - *Armor the top of the fill* - Install a second trenched buttress for large rock fill at the break-in-slope between the outboard road edge and the top of the fill face.
- If water is expected during the time of use, an adequately sized pipe shall be installed to handle the flow if present (min. 6 inch).
 - The pipe shall be laid over the armored ford surface.
 - The inlet should be at grade with the upstream flow.
 - The outlet shall drain onto the outlet armoring of the rocked ford.
 - A layer of clean native shall be installed over the pipe to establish the running surface of the truck road.
 - Following use, the temporary pipe shall be removed and the placed native soil shall be removed and drifted along the approaches.
 - No significant alteration to the bed and bank of the stream shall occur.
- Road approaches to armored fords shall be treated with seed and straw mulch out to the first drainage structure (i.e. waterbar) or hydrologic divide to prevent transport of sediment pursuant to Item 18, Section II.
- Bank and channel armoring may occur when appropriate to provide channel and bank stabilization.
- Armored ford armoring shall be reapplied following use as needed to maintain a permanent crossing.

BMP: Armored Ford [Fill] (Cont.)

FIGURE 120. This armored fill crossing of a steep, ephemeral stream was constructed to provide a low maintenance crossing. The crossing has been deeply dipped to reduce the volume of road fill and to eliminate the potential for stream diversion. The fill slope has been heavily armored through the axis of the crossing to contain flood flows and prevent down-cutting. Armored fills cannot be used on fish bearing streams.

HANDBOOK FOR FOREST, RANCH AND RURAL ROADS

BMP: Armored Ford [Fill] (Cont.)



FIGURE 121D. Well graded rock armor is then backfilled into the structure and spread across the breadth of the U-shaped stream crossing, and about one-third the way up the roadbed, so that streamflow will only flow over or come in contact with resistant armor material. The armor must be spread and compacted across the design width of the expected flood flow channel width so peak flows will not flank the armored structure.



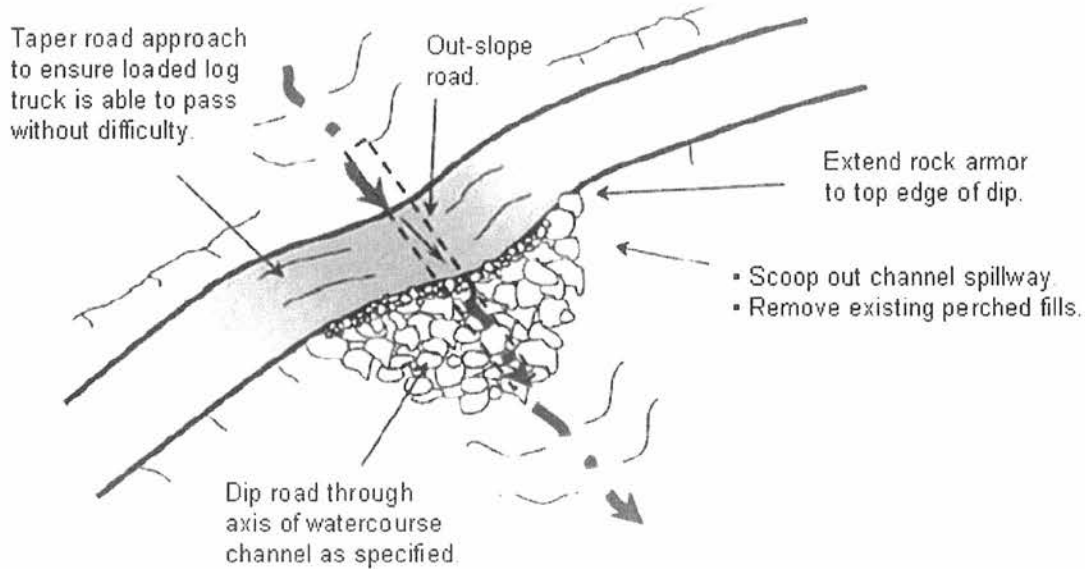
FIGURE 121E. Two weeks after this armored fill was constructed, a storm flow event occurred and the structure maintained its function and integrity. The road approaches had not yet been compacted or surfaced with road rock.



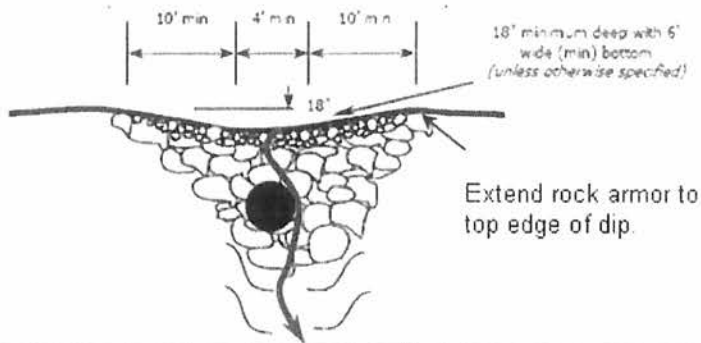
FIGURE 121F. The same armored fill as it appeared after the first winter flood flows. No maintenance was required to reopen the road. It is also clear that no stream diversion is possible at this stream crossing site, and the volume of fill within the crossing has been reduced to the minimum amount needed to maintain a relatively smooth driving surface on this low volume road.

BMP: Vented Ford

Vented Ford

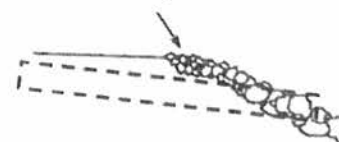


Dip area to accommodate a culvert sized for 100-year flow (minimum dimensions given below).



LIP

- Use smaller rock at lip of ford.
- Fill voids with smaller rock to prevent piping around the larger rock.



BMP: Crossing Abandonment

- Excavate and removing all fill materials placed in the stream channel when the crossing was originally built.
- Excavated banks shall be laid back to a 2:1 (50%) or natural slope to prevent slumping and soil movement.
- Fill material should be excavated to recreate the original channel grade (slope) and orientation.
- All bare soils should then be mulched, seeded, and planted to minimize erosion until vegetation can protect the soil surface.
- The approaching road segments shall be cross-road(waterbars) drained to prevent road runoff from discharging across the freshly excavated channel sideslopes.
- When fills are removed, they shall be excavated to form a channel that is as close as feasible to natural watercourse grade and orientation.
- The excavated channel bed should be as wide, or slightly wider than, the original watercourse channel.
 - This can be better determined by observing the channel width of the watercourse up slope of crossing to be removed at a point in which the crossing or any other disturbance has not affected the natural channel slope and width.
- Temporary crossings shall be removed by November 15.
 - Any temporary culvert crossing left in after October 15 or installed between October 15 and May 1, shall be sized to accommodate the estimated 100-year flow.
- In certain situations, bank and channel rock and woody debris armoring may be appropriate to provide channel and bank stabilization.

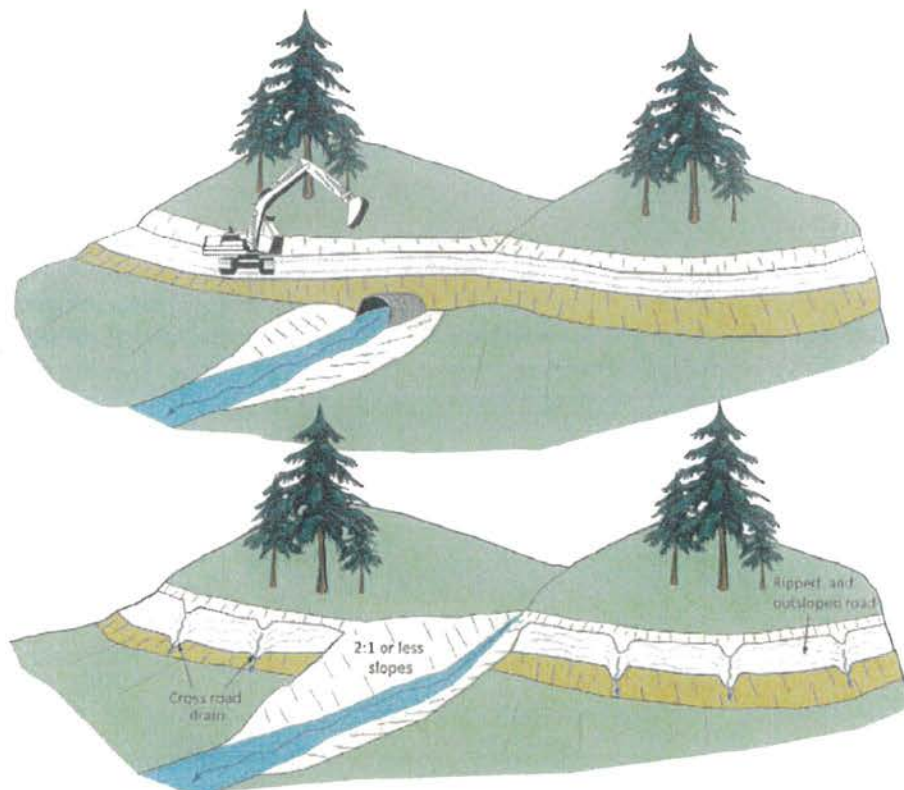


FIGURE 263. On roads that are to be closed (decommissioned), all stream crossing culverts and fills should be removed. Stream crossing excavations are best performed using an excavator. The original channel should be excavated and exhumed down to the former streambed, with a channel width equal or greater than the natural channel above and below the crossing. Sideslopes should be laid back to a stable angle, typically a 2:1 (50%) gradient, or less. Spoil can be endhailed off-site or stored on the road bench adjacent the crossing, provided it is placed and stabilized where it will not erode or fail and enter the stream.

BMP: Rolling Dip Design and Placement

- Rolling dips are drainage structures designed to force surface water to be drained from the road surface.
- The road shall dip into, and rise out of, the rolling dip to eliminate the potential of road surface runoff to run further down road way.
- The rolling dip shall be constructed with clean native materials or rock surfaced where specified.
- The rolling dips outlet may be armored to resist down-cutting and erosion of the outboard road fill.
- Do not discharge rolling dips into any areas that show signs of instability or active landsliding.
- If the rolling dip is designed to divert both road surface and ditch runoff, block the down-road ditch with compacted fill in order to force all ditch flows through the trough (low point) of the rolling dip.

BMP: Rocked Rolling Dip Design and Placement

- Rocked rolling dips are drainage structures designed to carry known sources of surface water across road ways or from known persistently wet segments of road such as swales without defined watercourses or road segments with heavy bank/road seepage.
- The road shall dip into, and rise out of, the rocked rolling dip to minimize diversion potential.
- The rocked rolling dip shall be constructed with clean rock that is large enough to remain in place during peak flows. Rock size shall vary relative to the anticipated flow through the dip with larger rock used in location where greater flow is anticipated.
- The rocked rolling dips inlet and outlet shall be armored to resist down-cutting and erosion.
- The entire width of the rocked rolling dip shall be rock armored to a minimum of 5-feet from the centerline of the dipped portion of the rolling dip.
- If a keyway is necessary, the rocked rolling dip keyway at the base of the dip shall be of sufficient size, depth and length to support materials used in the rocked rolling dip construction back up to the road crossing interface.
- Do not discharge rolling dips into any areas that show signs of instability or active landsliding.
- If the rolling dip is designed to divert both road surface and ditch runoff, block the down-road ditch with compacted fill.
- The rolling dip should be designed as a broad feature ranging from 10-100 feet long so that it is drivable by most types of vehicular traffic and not significantly inhibit traffic and road use.

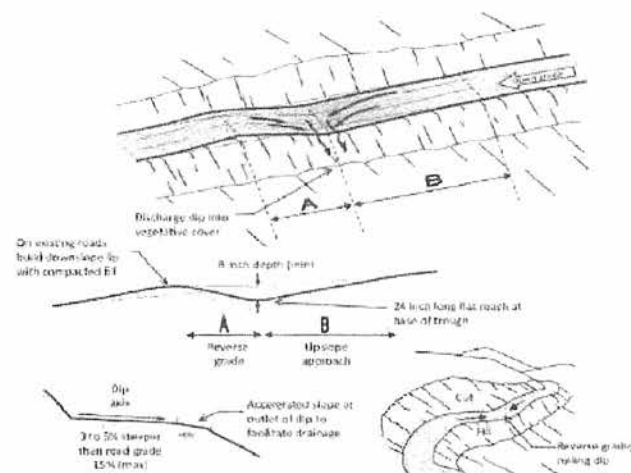


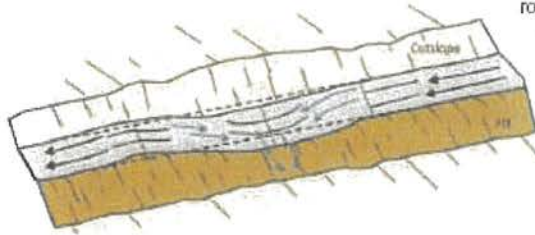
FIGURE 34. A classic Type I rolling dip, where the excavated up-road approach (B) to the rolling dip is several percent steeper than the approaching road and extends for 60 to 80 feet to the dip axis. The lower side of the structure reverses grade (A) over approximately 15 feet or more, and then falls down to rejoin the original road grade. The dip must be deep enough that it is not obliterated by normal grading, but not so deep that it is difficult to negotiate or a hazard to normal traffic. The outward cross-slope of the dip axis should be 3% to 5% greater than the up-road grade (B) so it will drain properly. The dip axis should be out-sloped sufficiently to be self-cleaning, without triggering excessive downcutting or sediment deposition in the dip axis (Modified from: Best, 2013).

HANDBOOK FOR FOREST, RANCH AND RURAL ROADS

BMP: Rolling Dip Design and Placement (Types)

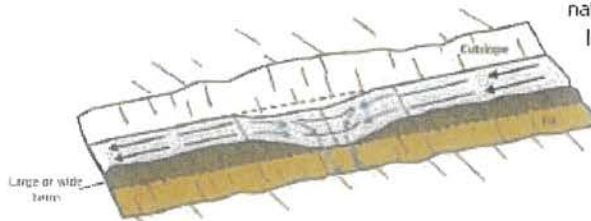
Type 1 Rolling Dip (Standard)

Type 1 rolling dips are used where road grades are less than about 12-14% and road runoff is not confined by a large through cut or berm. The axis of the dip should be perpendicular to the road alignment and sloped at 3-4% across the road tread. Steep roads will have longer and more abrupt dip dimensions to develop reverse grade through the dip axis. The road tread and/or the dip outlet can be rocked to protect against erosion, if needed.



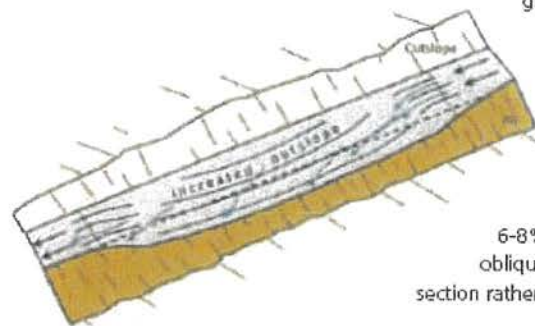
Type 2 Rolling Dip (Through-cut or thick berm road reaches)

Type 2 rolling dips are constructed on roads up to 12-14% grade where there is a through cut up to 3 feet tall, or a wide or tall berm that otherwise blocks road drainage. The berm or native through cut material should be removed for the length of the dip, or at least through the axis of the dip, to the extent needed to provide for uninterrupted drainage onto the adjacent slope. The berm and slope material can be excavated and endhailed, or the material can be sidecast onto native slopes up to 45%, provided it will not enter a stream.



Type 3 Rolling Dip (Steep road grade)

Type 3 rolling dips are utilized where road grades are steeper than about 12% and it is not feasible to develop a reverse grade that will also allow passage of the design vehicle (steep road grades require more abrupt grade reversals that some vehicles may not be able to traverse without bottoming out).



Instead of relying on the dip's grade reversal to turn runoff off the roadbed, the road is built with an exaggerated outslope of 6-8% across the dip axis. Road runoff is deflected obliquely across the dip axis and is shed off the outsloped section rather than continuing down the steep road grade.

FIGURE 36. Rolling dip types

BMP: Rolling Dip Design and Placement

FIGURE 33A. Rolling dip constructed on a rock surfaced rural road. The rolling dip represents a change-in-grade along the road alignment and acts to discharge water that has collected on, or is flowing down, the road surface. This road was recently converted from a high maintenance, insloped, ditched road to a low maintenance, outsloped road with rolling dips.



FIGURE 33B. This side view of an outsloped road shows that the rolling dip does not have to be deep or abrupt to reverse road grade and effectively drain the road surface. This outsloped forest road has rolling dips that allow all traffic types to travel the route without changing speed.



BMP: Waterbar/Rolling Dip Combined with DRC



FIGURE 39.

Waterbars are often used to drain surface runoff from seasonal, unsurfaced roads. Because they are easily broken down by vehicles, waterbars are only used on unsurfaced roads where there is little or no wet weather traffic. In this photo, a waterbar and ditch relief culvert are used to drain all road surface and ditch runoff from the insloped road prism.

HANDBOOK FOR FOREST, RANCH AND RURAL ROADS

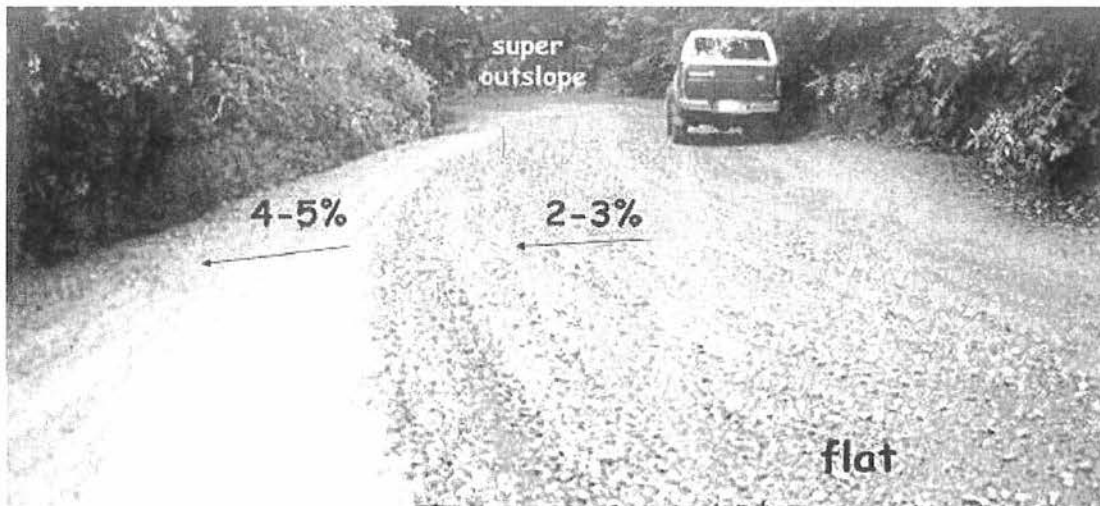
Diagram shows and discussed the use of a waterbar. However, a DRC combined with a rolling dip structure provides the same surface and ditch drainage for roads used year-round. Just as with the waterbar in the photo above, The DRC is installed just upslope from the rolling dip. This also creates a fail-safe should the DRC become plugged or overwhelmed.



FIGURE 238. *Traffic and surface runoff from graveled roads often produces surface erosion, turbid runoff and fine sediment transport that can be delivered to streams. Where ditches can't be eliminated, sediment traps and roadside settling basins can be installed to capture and remove most of the eroded sediment. This settling basin has been constructed along the inside ditch just before a stream crossing culvert inlet (see arrow). Eroded sediment from the road and ditch are deposited in the basin before flow is released to the stream. Fine sediments have filled about 1/3 of this basin and vegetation is now growing. Sediment basins require periodic maintenance to maintain their storage capacity.*

HANDBOOK FOR FOREST, RANCH AND RURAL ROADS

BMP: Road Outsloping/Insloping



HANDBOOK FOR FOREST, RANCH, AND RURAL ROADS

FIGURE 29. Road shape changes as the road travels through the landscape. For example, an out-sloped road will have a steep or "banked" outslope through inside curves, a consistent outslope through straight reaches and a flat or slightly insloped shape as it goes through an outside curve. The road may have an outslope of 2-3% across the travel surface while the shoulder is more steeply outsloped to ensure runoff and sediment will leave the roadbed.

BMP: Steep Road Drainage Features



FIGURE 55. Steep roads that go straight up or down a hillside are very difficult to drain. This steep, fall line road developed a through cut cross section that was drained using lead out ditches to direct runoff off the road and onto the adjacent, vegetated hillside. The road was "outsloped" to drain runoff to the right side, and the lead out ditch was built slightly steeper than the road grade, to be self-cleaning. Four lead out ditches have been constructed at 100-foot intervals to the bottom of the hillside.

HANDBOOK FOR FOREST, RANCH AND RURAL ROADS

BMP: Ditch Relief Culvert

- Install ditch relief culverts at an oblique (typically 30 degree) angle to the road so that ditch flow does not have to make a sharp angle turn to enter the pipe. On low gradient roads (<5%), where ditch flow is slow, ditch relief culverts can be installed at right angles to the road.
- Install ditch relief culverts (DRC) to outlet at, and drain to, the base of the fill
- If it cannot be installed at the base of the fill, install the DRC with a grade steeper than the inboard ditch draining to the culvert inlet, and then install a downspout on the outlet to carry the culverted flow to the base of the fillslope or energy dissipater material at outlet to prevent erosion or the outboard road fill.
- Downspouts longer than 20 feet should be secured to the hillslope for stability.
- Ditch relief culverts should not carry excessive flow such that gullying occurs below the culvert outlet or such that erosion and down-cutting of the inboard ditch is occurring.
- Do not discharge flows from ditch relief culverts onto unstable areas or highly erodible hillslopes.
- If the ditch is on an insloped or crowned road, consider reshaping road outsloping to drain the road surface. The ditch and the ditch relief culvert would then convey only spring flow from the cutbank and hillslope runoff, and not turbid runoff from the road surface.

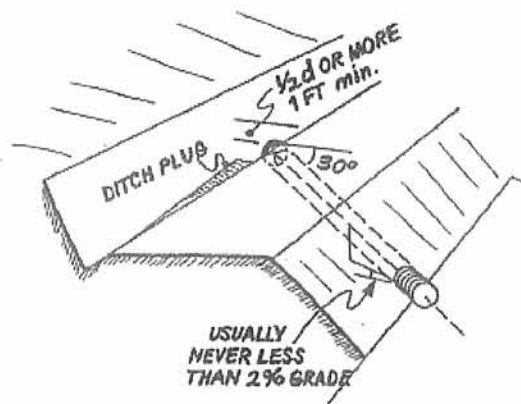
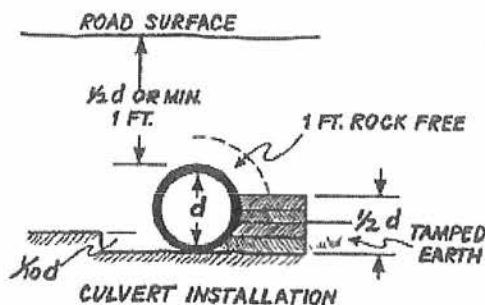


FIGURE 48. The elements of a properly installed ditch relief culvert. The culvert is angled at about 30 degrees to the road alignment to help capture flow and prevent culvert plugging or erosion of the inlet area. It is set at the base of the fill (ideally) or with a grade slightly steeper than the grade of the contributing ditch (but never with a grade less than 2 percent) (USDA-SCS, 1983). At a minimum, the grade of the ditch relief culvert should be sufficient to prevent sediment accumulation at the inlet or deposition within the culvert itself (it should be self-cleaning) (USDA-SCS, 1983).

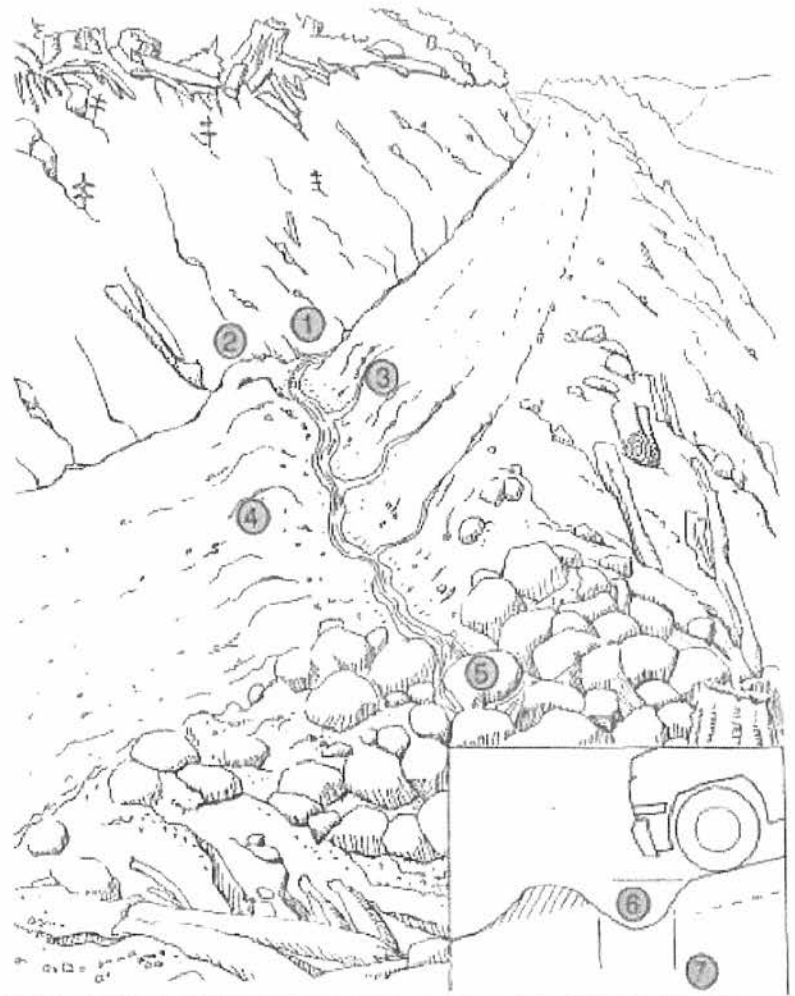


HANDECOX FOR FOREST, RANCH AND RURAL ROADS

BMP: Waterbar Construction

FIGURE 40. Waterbars are constructed on unsurfaced forest and ranch roads that will have little or no traffic during the wet season. The waterbar should be extended to the cutbank to intercept all ditch flow (1) and extend beyond the shoulder of the road. A berm (2) must block and prevent ditch flow from continuing down the road during flood flows. The excavated waterbar (3) should be constructed to be self-cleaning, typically with a 30° skew to the road alignment with the excavated material bermed on the downhill grade of the road (4). Water should always be discharged onto the downhill side on a stable slope protected by vegetation. Rock (shown in the figure) should not be necessary if waterbars are spaced close enough to prevent serious erosion. (5) The cross ditch depth (6) and width (7) must allow vehicle cross-over without destroying the function of the drain. Several alternate types of waterbars are possible, including one that drains only the road surface (not the ditch), and one that drains the road surface into the inside ditch (BCMF, 1991).

HANDBOOK FOR FOREST, RANCH, AND RURAL ROADS

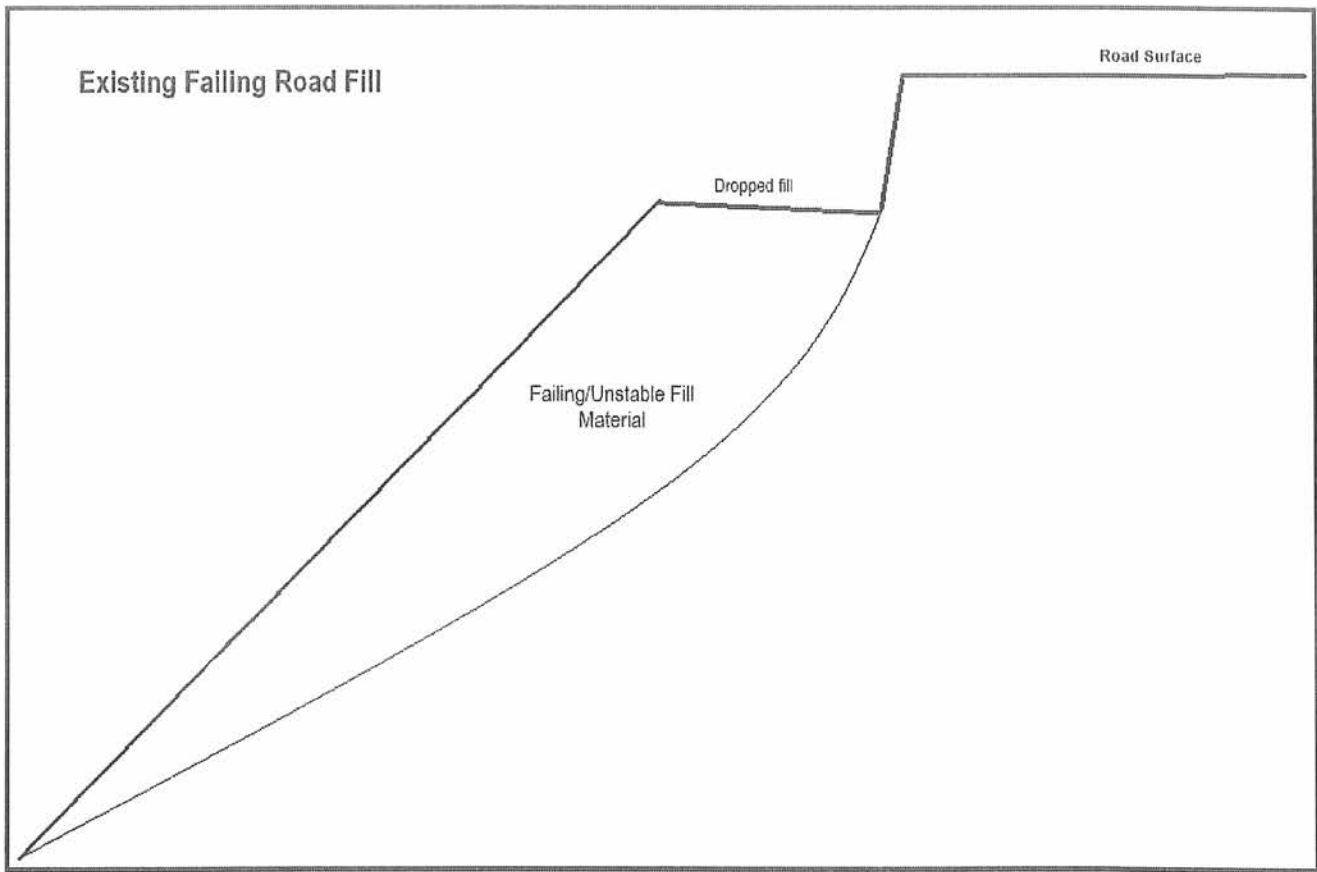


BMP: Unstable Fill Removal and Treatment

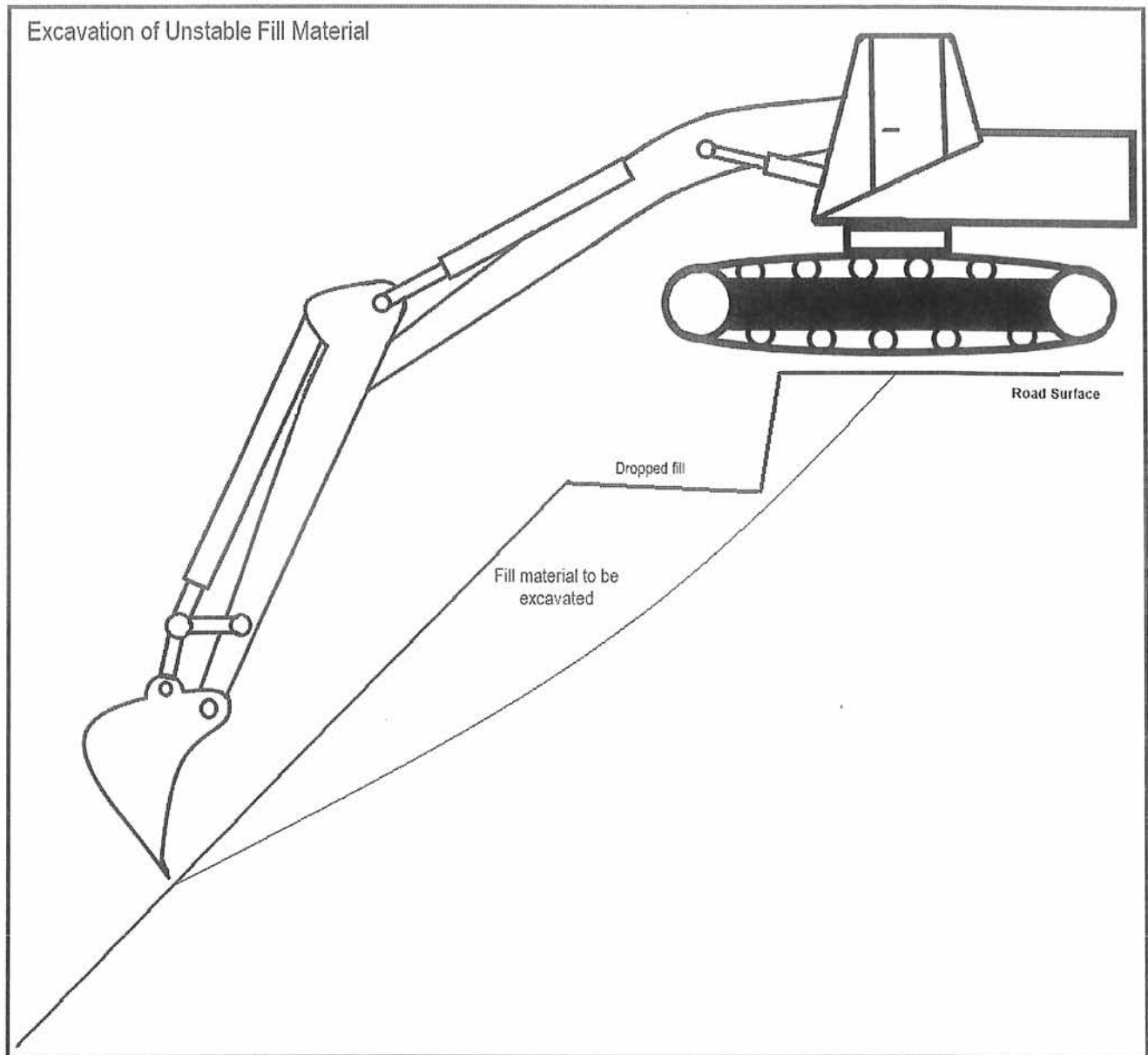


FIGURE 230. The most cost-effective treatment for unstable fills along the outside of a forest, ranch or rural road is simply the direct excavation of the unstable material. If road width is too narrow, additional width can often be derived from cutting into the bank. The excavation should encompass the unstable fill materials, beginning at the inside crack or scarp, and extending out and down the fill slope as far as possible. For proper surface drainage, and to retrieve most of the unstable fill, the excavation should have a concave profile when completed. Typically, the bulk of the fill is within 20 to 25 feet of the outside edge of the road and is easily reached by a midsized excavator. Any remaining fill is likely to be small enough that it will not fail or travel far enough to reach the stream.

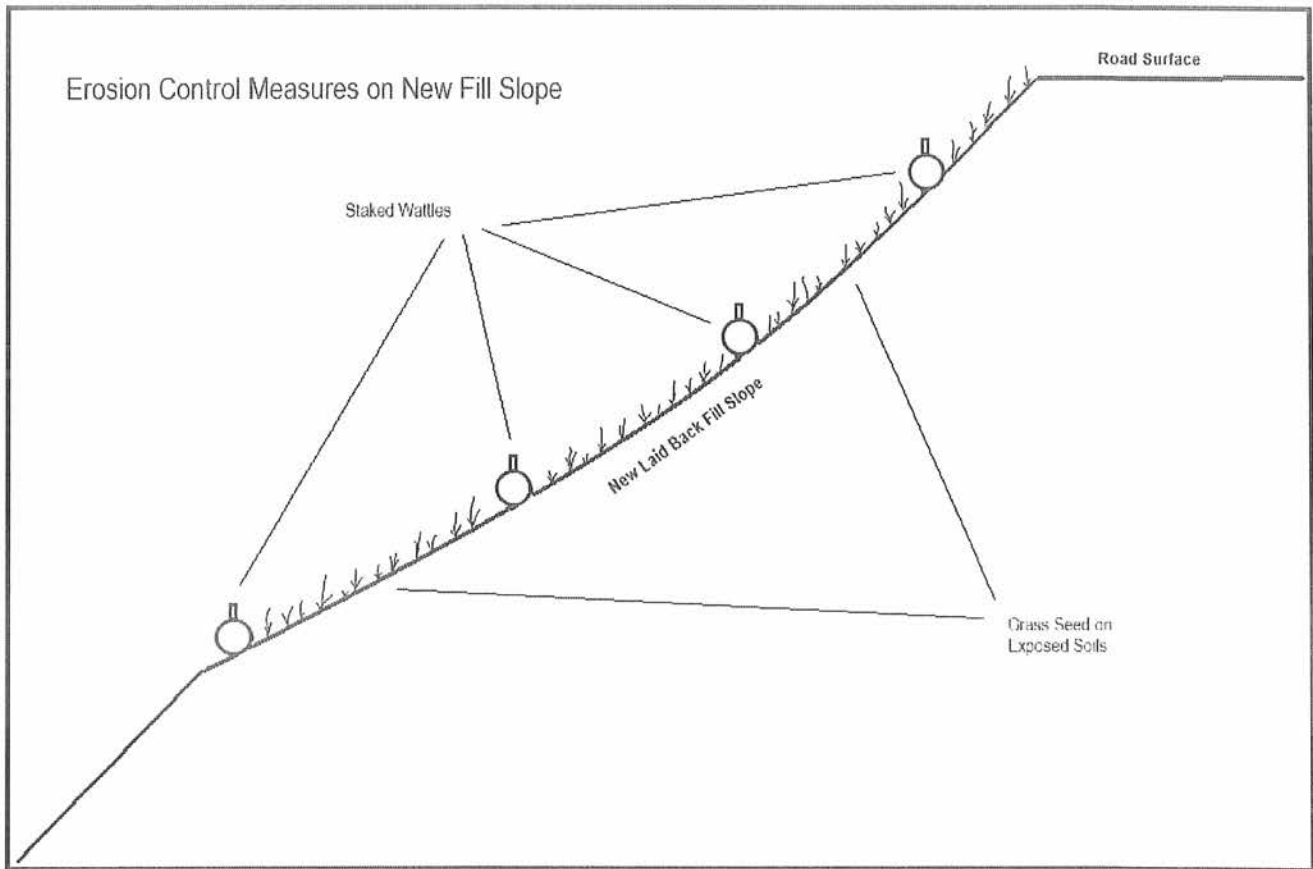
BMP: Unstable Fill Removal and Treatment



BMP: Unstable Fill Removal and Treatment



BMP: Unstable Fill Removal and Treatment



BMP: Rock Armor Cutbank



FIGURE 52. This wet and potentially unstable cut slope on a newly constructed road was stabilized using a buttress of large rock armor. To assure their effectiveness, rock buttresses and other retaining structures should be designed by a qualified engineer or engineering geologist.

HANDBOOK FOR FOREST, RANCH AND RURAL ROADS

BMP: Rip-Rap Size Class Table

TABLE 25. Standard classification and gradation of riprap by size of rock¹

Riprap size class	Median particle weight ²	Median particle diameter ² (in)	Minimum and maximum allowable particle size (in) ²						
			D ₁₅		D ₅₀		D ₈₅		D ₁₀₀
			Min	Max	Min	Max	Min	Max	Max
Class I	20 lb	6	3.7	5.2	5.7	6.9	7.8	9.2	12.0
Class II	60 lb	9	5.5	7.8	8.5	10.5	11.5	14.0	18.0
Class III	150 lb	12	7.3	10.5	11.5	14.0	15.5	18.5	24.0
Class IV	300 lb	15	9.2	13.0	14.5	17.5	19.5	23.0	30.0
Class V	¼ ton	18	11.0	15.5	17.0	20.5	23.5	27.5	36.0
Class VI	3/8 ton	21	13.0	18.5	20.0	24.0	27.5	32.5	42.0
Class VII	½ ton	24	14.5	21.0	23.0	27.5	31.0	37.0	48.0
Class VIII	1 ton	30	18.5	26.0	28.5	34.5	39.0	46.0	60.0
Class IX	2 ton	36	22.0	31.5	34.0	41.5	47.0	55.5	72.0
Class X	3 ton	42	25.5	36.5	40.0	48.5	54.5	64.5	84.0

¹Lagasse et al (2006)

²Equivalent to spherical diameter

BMP: Storage Bladders

- Storage bladders shall be located and designed to minimize the potential for impacts due to rolling and/or failure. Storage bladders should be stored on flat slopes where stability will not be affected.
- Storage bladders shall be located to minimize the potential for water to flow into a watercourse in the event of a catastrophic failure.
- Bladders shall not be used unless the bladder is safely contained within a secondary containment system with sufficient capacity to capture 110 percent of a bladders maximum volume in the vent of bladder failure.
- Secondary containment is recommended in the form of a dirt berm, containment pit, combination of both, or impermeable material with skeletal support. The containment should be capable of holding 110 percent of the bladders volume.
- Secondary containment systems shall be of sufficient strength and stability to withstand the forces of released contents in the event of catastrophic bladder failure.
- Secondary containment systems that are exposed to precipitation shall be designed and maintained with sufficient capacity to accommodate precipitation and storm water inputs from a 25-year, 24-hour storm event.
- Bladders and containment systems shall be periodically inspected to ensure integrity.



This is an example of a containment pit which will assist in mitigating the impacts if this storage bladder failed.

BMP: Cultivation Site Restoration

- Remove all cultivation and associated materials from designated cultivation site.
 - This includes plant mass, root balls, potting containers, cultivation medium and any materials associated with the preparation, cultivation, and harvest of commercial cannabis.
 - Cultivation medium removed from the site shall be stored/disposed of in compliance with Order conditions related to spoils management.
- All disturbed and/or unstable slopes shall be stabilized and returned to pre-project conditions.
 - Slopes shall be contoured as close as feasible to natural grade and aspect.
 - Temporary erosion control shall be applied to prevent sediment run-off.
- Soil exposed as a result of project work, soil above rock riprap, and interstitial spaces between rocks shall be revegetated with native species by live planting, seed casting, or hydroseeding prior to the rainy season of the year work is completed.
 - Native plants characteristic of the local habitat shall be used for revegetation when implementing and maintaining cleanup/restoration work in riparian and other sensitive areas.
 - Native forbes and graminoids shall be planted to replace sediment stabilization, sediment filtration and nutrient filtration
 - Native trees and shrubs shall be planted to replace bank stabilization, inputs of large woody debris and temperature control within riparian areas.
 - Restoration of the quality/health of the riparian stand shall promote: 1) shade and microclimate controls; 2) delivery of wood to channels, 3) slope stability and erosion control, 4) ground cover, and 5) removal of excess nutrients.

Monitoring Plan

Cannabis cultivators shall regularly inspect and maintain the condition of access roads, access road drainage features, and watercourse crossings. At a minimum, cannabis cultivators shall perform inspections prior to the onset of fall and winter precipitation and following storm events that produce at least 0.5 in/day or 1.0 inch/7 days of precipitation. See Required Monitoring tables below for site specific monitoring and reporting requirements. Cannabis cultivators are required to perform all of the following maintenance:

- Remove any wood debris that may restrict flow in a culvert.
- Remove sediment that impacts access road or drainage feature performance.
- Place any removed sediment in a location outside the riparian setbacks and stabilize the sediment.
- Maintain records of access road and drainage feature maintenance for annual reporting.

Cannabis cultivators that are operating in areas that are, or may become, inaccessible during winter months due to extreme weather such as snow, road closures, seasonal access roads to the property, or any other such conditions shall make additional efforts to enhance winterization measures in the absence of monitoring during storm events.

Monitoring Requirements

(Tier 1, Low Risk, < 1 acre of cultivation)

Monitoring Requirement	Description
Winterization Measures Implemented	Report winterization procedures implemented, any outstanding measures, and the schedule for completion.
Tier Status Confirmation	Report any changes in the tier status.
Third Party Identification	Report any change in third party status as appropriate.

Annual Reporting

Annual Reports shall be submitted to the North Coast Regional Water Quality Control Board by March 1st following the year being monitored. The first Annual Report for this enrollment shall be submitted by March 1st, 2020 and report on monitoring done during the 2019 calendar year. Annual reporting is required each subsequent year of enrollment.

Attachments

Implementation of Applicable BPTC Measures

Assessment of applicable BPTC measures consisted of a field examination on January 29th, 2020. Anywhere applicable BPTC measures are not met on the property, descriptions of the assessments and the prescribed treatments are outlined following each associated section below.

Summary of BPTC Measures Compliance

1. Sediment Discharge BPTC Measures Y/N
2. Fertilizer, Pesticide, Herbicide, and Rodenticide BPTC Measures Y/N
3. Petroleum Product BPTC Measures Y/N
4. Trash/Refuse, and Domestic Wastewater BPTC Measures Y/N
5. Winterization BPTC Measures Y/N

1. Sediment Discharge BPTC Measures

1.1. Site Characteristics

- 1.1.1. Provide a map showing access roads, vehicle parking areas, streams, stream crossings, cultivation site(s), disturbed areas, buildings, and other relevant site features.

See attached Site Map.

- 1.1.2. Describe the access road conditions including estimating vehicle traffic, road surface (e.g., paved, rocky, or bare ground), and maintenance activities. Describe how storm water is drained from the access road (e.g., crowned, out slope, armored ditch, culverts, rolling dips, etc.).

See sections "Land Development and Maintenance, Erosion Control, and Drainage Features" above, and the attached Mitigation Report, Site Maps, and Treatment Implementation Schedule for site specific descriptions, treatments, and the implementation schedule.

- 1.1.3. Describe any vehicle stream crossing including the type of crossing (e.g., bridge, culvert, low water, etc.).

See the section titled "Stream Crossing Installation and Maintenance" or the attached Mitigation Report and Site Maps for site specific details and treatment schedules.

- 1.1.3.1. For Region 1 Dischargers, identify, discuss, and locate on the site map any legacy waste discharge issues that exist on the property.

Not applicable. No legacy waste discharge issues were identified during the assessment of the property. A legacy road was identified on the property as this road was constructed for

past timber harvest activities. The road has already been abandoned. Two watercourse crossings were identified on this legacy road. No waste discharge issue was observed at either of the watercourse crossings and they appear to be functioning adequately, despite being undersized. These culverts will be regularly monitored and cleared of any blockages that occur.

- 1.2. Sediment Erosion Prevention and Sediment Capture (Moderate risk Tier 1 or Tier 2 Dischargers are required to submit a Site Erosion and Sediment Control Plan. Those Dischargers may refer to that plan rather than repeat it here)

1.2.1. Erosion Prevention BPTC Measures

- 1.2.1.1. Describe the BPTC measures that have been, or will be implemented to prevent or limit erosion. Provide an implementation schedule for BPTC measures that have not yet been implemented. Identify the erosion prevention BPTC measures on a site map.

See sections “Land Development and Maintenance, Erosion Control, and Drainage Features” and attached Mitigation Report, Site Maps, and Treatment Implementation Schedule for site specific descriptions of physical BPTC measures being prescribed.

- 1.2.1.1.1. The description shall address physical BPTC measures, (e.g., placement of straw mulch, plastic covers, slope stabilization, soil binders, culvert outfall armoring, etc.) and biological BPTC measures (vegetation preservation/replacement, hydro seeding, etc.).

See the attached Mitigation Report and Best Management Practices (BMPs) for descriptions of physical BPTC measures being prescribed.

1.2.2. Sediment Control BPTC Measures

- 1.2.2.1. Describe the BPTC measures that have been, or will be implemented to capture sediment that has been eroded. Provide an implementation schedule for BPTC measures that have not yet been implemented. Identify the sediment control BPTC measures on a site map.

Not applicable. No BPTC measures have been, or will need to be, implemented to capture sediment that has been eroded.

- 1.2.2.1.1. The description shall address physical BPTC measures, (e.g., placement of silt fences, fiber rolls, or settling ponds/areas, etc.) and biological BPTC measures (vegetated outfalls, hydro seeding, etc.).

There are no physical or biological BPTC measures being prescribed.

1.2.3. Maintenance Activities - Erosion Prevention and Sediment Control

1.2.3.1. Describe how the erosion prevention and sediment control BPTC measures will be monitored and maintained to protect water quality.

Erosion prevention BPTC measures and all corresponding work shall be inspected prior to and in conjunction with winter monitoring, as described above under the "Monitoring Plan" to ensure proper placement, installation, and function remain intact prior to and throughout the Winter Period.

1.2.3.2. Describe how any captured sediment will be either stabilized in place, excavated and stabilized on-site, or removed from the site.

Not applicable.

1.2.4. Erosion control BPTC measures: Describe the interim soil stabilization, if applicable and long-term BPTC measures implemented to prevent sediment transport at each identified disturbed area(s) and improperly constructed features.

Not applicable. There was no erosion observed at any of the disturbed areas and there are no improperly constructed features. Disturbed areas are located on gentle slopes surrounded by vegetation and grass buffers.

2. Fertilizer, Pesticide, Herbicide, and Rodenticide BPTC Measures

2.1. Provide a summary table that identifies the products used at the site, when they are delivered to the site, how they are stored, and used at the site. If products are not consumed during the growing season, describe how they are removed from the site or stored to prevent discharge over the winter season.

See comprehensive table under 2.3

2.2. Provide a site map that locates storage locations.

See attached Site Map. Fertilizers and soil amendments are currently stored properly within the shipping containers and sheds.

2.3. Describe how bulk fertilizers and chemical concentrates are stored, mixed, applied, and how empty containers are disposed.

Fertilizer, Pesticides, and Herbicide Products used on Site

Product	Delivery and Storage	On-site usage	How removed or stored
Advanced Nutrients Beastie Blooms	Brought to property as needed. Stored within the shipping containers and sheds with all other fertilizers and amendments over winter or alongside mixing tanks while in use. Stored alongside mixing tanks while in use.	Mixed into tank with water. It is then hand watered to plants as needed.	Stored within the storage structures over winter. Empty containers are disposed of at an appropriate waste disposal facility.
Advanced Nutrients Cha Ching	Brought to property as needed. Stored within the shipping containers and sheds with all other fertilizers and amendments over winter or alongside mixing tanks while in use. Stored alongside mixing tanks while in use.	Mixed into tank with water. It is then hand watered to plants as needed.	Stored within the storage structures over winter. Empty containers are disposed of at an appropriate waste disposal facility.
Eco Nutrients Liquid Bone Meal	Brought to property as needed. Stored within the shipping containers and sheds with all other fertilizers and amendments over winter or alongside mixing tanks while in use. Stored alongside mixing tanks while in use.	Mixed into tank with water. It is then hand watered to plants as needed.	Stored within the storage structures over winter. Empty containers are disposed of at an appropriate waste disposal facility.
General Hydroponics CaliMagic	Brought to property as needed. Stored within the shipping containers and sheds with all other fertilizers and amendments over winter	Mixed into tank with water. It is then hand watered to plants as needed.	Stored within the storage structures over winter. Empty containers are disposed of at an appropriate waste disposal facility.

	or alongside mixing tanks while in use. Stored alongside mixing tanks while in use.		
General Hydroponics Flora Nova Grow	Brought to property as needed. Stored within the shipping containers and sheds with all other fertilizers and amendments over winter or alongside mixing tanks while in use. Stored alongside mixing tanks while in use.	Mixed into tank with water. It is then hand watered to plants as needed.	Stored within the storage structures over winter. Empty containers are disposed of at an appropriate waste disposal facility.
General Hydroponics MaxiGro	Brought to property as needed. Stored within the shipping containers and sheds with all other fertilizers and amendments over winter or alongside mixing tanks while in use. Stored alongside mixing tanks while in use.	Mixed into tank with water. It is then hand watered to plants as needed.	Stored within the storage structures over winter. Empty containers are disposed of at an appropriate waste disposal facility.
Grow More Line of fertilizers	Brought to property as needed. Stored within the shipping containers and sheds with all other fertilizers and amendments over winter or alongside mixing tanks while in use. Stored alongside mixing tanks while in use.	Mixed into tank with water. It is then hand watered to plants as needed.	Stored within the storage structures over winter. Empty containers are disposed of at an appropriate waste disposal facility.
Humboldt Ag Supply Plant Nitrogen	Brought to property as needed. Stored within the shipping containers and sheds with all other fertilizers and amendments over winter or alongside mixing tanks while in use. Stored alongside mixing tanks while in use.	Mixed into tank with water. It is then hand watered to plants as needed.	Stored within the storage structures over winter. Empty containers are disposed of at an appropriate waste disposal facility.
MaxSea All purpose	Brought to property as needed. Stored within the shipping containers and sheds with all other fertilizers and amendments over winter or alongside mixing tanks while in use. Stored alongside mixing tanks while in use.	Mixed into tank with water. It is then hand watered to plants as needed.	Stored within the storage structures over winter. Empty containers are disposed of at an appropriate waste disposal facility.
MaxSea Bloom	Brought to property as needed. Stored within the shipping containers and sheds with all other fertilizers and amendments over winter or alongside mixing tanks while in use. Stored	Mixed into tank with water. It is then hand watered to plants as needed.	Stored within the storage structures over winter. Empty containers are disposed of at an appropriate waste disposal facility.

	alongside mixing tanks while in use.		
Sparetime Seaweed powder	Brought to property as needed. Stored within the shipping containers and sheds with all other fertilizers and amendments over winter or alongside mixing tanks while in use. Stored alongside mixing tanks while in use.	Mixed into tank with water. It is then hand watered to plants as needed.	Stored within the storage structures over winter. Empty containers are disposed of at an appropriate waste disposal facility.
Sparetime Supply Molasses	Brought to property as needed. Stored within the shipping containers and sheds with all other fertilizers and amendments over winter or alongside mixing tanks while in use. Stored alongside mixing tanks while in use.	Mixed into tank with water. It is then hand watered to plants as needed.	Stored within the storage structures over winter. Empty containers are disposed of at an appropriate waste disposal facility.
Shrimp Meal	Brought to property as needed. Stored within the shipping containers and sheds with all other fertilizers and amendments.	Amended into potting soils as needed.	Stored within the storage structures over winter. Empty containers are disposed of at an appropriate waste disposal facility.
Crab Meal	Brought to property as needed. Stored within the shipping containers and sheds with all other fertilizers and amendments.	Amended into potting soils as needed.	Stored within the storage structures over winter. Empty containers are disposed of at an appropriate waste disposal facility.
Feather Meal	Brought to property as needed. Stored within the shipping containers and sheds with all other fertilizers and amendments.	Amended into potting soils as needed.	Stored within the storage structures over winter. Empty containers are disposed of at an appropriate waste disposal facility.
Neem Seed Meal	Brought to property as needed. Stored within the shipping containers and sheds with all other fertilizers and amendments.	Amended into potting soils as needed.	Stored within the storage structures over winter. Empty containers are disposed of at an appropriate waste disposal facility.
Mocha Bat Guano	Brought to property as needed. Stored within the shipping containers and sheds with all other fertilizers and amendments.	Amended into potting soils as needed.	Stored within the storage structures over winter. Empty containers are disposed of at an appropriate waste disposal facility.
Bat Guano	Brought to property as needed. Stored within the shipping containers and sheds with all other fertilizers and amendments.	Amended into potting soils as needed.	Stored within the storage structures over winter. Empty containers are disposed of at an appropriate waste disposal facility.
Seabird Guano	Brought to property as needed. Stored within the shipping containers and sheds with all other	Amended into potting soils as needed.	Stored within the storage structures over winter. Empty containers are disposed of at an

	fertilizers and amendments.		appropriate waste disposal facility.
Kelp Meal	Brought to property as needed. Stored within the shipping containers and sheds with all other fertilizers and amendments.	Amended into potting soils as needed.	Stored within the storage structures over winter. Empty containers are disposed of at an appropriate waste disposal facility.
Alfalfa Meal	Brought to property as needed. Stored within the shipping containers and sheds with all other fertilizers and amendments.	Amended into potting soils as needed.	Stored within the storage structures over winter. Empty containers are disposed of at an appropriate waste disposal facility.

2.4. Describe procedures for spill prevention and cleanup.

Pesticides and liquid fertilizer containers are stored within a covered structure, within secured containers, with their lids secured after their use. The cannabis cultivator shall obtain adequate quantities of absorbent materials and ensure that they are stored at all locations where the materials above are used, stored, or mixed. Should a spill of these materials occur, absorbent materials will be applied immediately and allowed enough time to absorb as much material as possible. Following treatment, absorbent materials applied will be removed and disposed of appropriately as per the manufacturer’s guidelines.

3. Petroleum Product BPTC Measures

3.1. Provide a summary table that identifies the products used at the site, when they are delivered to the site, how they are stored, and used at the site. If products are not consumed during the growing season, describe how they are removed from the site or stored to prevent discharge over the winter season.

See comprehensive table under 3.3.

3.2. Provide a site map that locates storage locations.

See attached Site Map.

3.3. Describe how fuels, lubricants, and other petroleum products are stored, mixed, applied, and empty containers are disposed.

Petroleum Products

Products used on site	When they are delivered to site	How they are stored and used	How removed or stored
Gasoline	Brought to site when needed throughout the year.	Stored in standard 5-gallon gasoline canisters on the porch of the residence. Used to fuel equipment.	Stored in standard 5-gallon gasoline canisters on the porch of the residences or where it is used.
Diesel	Brought to site when needed throughout the year.	Stored in a 250 and 500-gallon steel fuel tank with secondary containment under cover from precipitation. Used to fuel generators and equipment.	Stored in a 250 and 500-gallon steel fuel tank with secondary containment with cover from precipitation.
Motor oil	Brought to site when needed throughout the year.	Stored in the shed alongside the 250 and 500-gallon steel fuel tank and the generator. Used to lubricate internal combustion engines.	After oil changes, the used motor oil is stored in either the container it came in or in sealed 5-gallon buckets for later disposal at an appropriate waste disposal facility.

3.4. Describe procedures for spill prevention and cleanup.

Any/all fuel canisters, motor oil containers, and generators, large or small, shall be stored in secondary containment (e.g. drip pans, plastic totes, or sealed metal boxes) while being stored long term or not in immediate use, wherever these materials are used anywhere on the property. Adequate quantities of absorbent materials are stored at all locations where these types of materials are used, stored, or mixed. Should a spill of these materials occur, absorbent materials will be applied immediately and allowed enough time to absorb as much material as possible. Following treatment, absorbent materials applied as well as any contaminated soil will be removed and disposed of appropriately for the spilled material.

4. Trash/Refuse, and Domestic Wastewater BPTC Measures

- 4.1. Describe the types of trash/refuse that will be generated at the site. Describe how the material is contained and properly disposed of.

Domestic and commercial cannabis refuse will be generated at the site. The refuse is securely stored in trash bags and trash bins at the cultivation areas, residences, and within a contained refuse storage shed adjacent to the residence prior to disposal at an appropriate waste disposal facility.

- 4.1.1. Provide a site map that locates the trash/refuse storage locations.

Refuse is stored in trash bags, trash bins, and a utility trailer at mapped cultivation areas and the houses. See attached Site Map.

- 4.2. Describe the number of employees, visitors, or residents at the site.

There are two regular employees who are at the site during the cultivation season. Additional employees are brought onto the property for short periods of time to complete projects requiring additional employees. Visitors are occasionally on site, including consultants and regulatory agencies. There is also a full-time residence on the property as well.

- 4.2.1. Describe the types of domestic wastewater generated at the site (e.g., household generated wastewater or chemical toilet).

Domestic sewage and wastewater (greywater) are generated on site.

- 4.2.2. Describe how the domestic wastewater is disposed.

- 4.2.2.1. Permitted onsite wastewater treatment system (e.g., septic tank and leach lines).

Domestic sewage is disposed via a permitted septic system. Greywater from seasonally used travel trailers and outdoor sinks is disposed of nearby where it is generated and allowed to infiltrate.

- 4.2.2.2. Chemical toilets or holding tank. If so, provide the name of the servicing company and the frequency of service.

Not applicable.

- 4.2.2.3. Outhouse, pit privy, or similar. Use of this alternative requires approval from the Regional Water Board Executive Officer; include the approval from the Executive Officer and any conditions imposed for use of this alternative.

Not applicable.

- 4.2.2.3.1. Provide a site map that locates any domestic wastewater treatment, storage, or disposal area.

See attached Site Map for locations of residences with attached septic and greywater systems.

5. Winterization BPTC Measures

- 5.1. Describe activities that will be performed to winterize the site and prevent discharges of waste. The description should address all the issues listed above.

See Mitigation Report and Annual Winterization Measures for prescribed general winterization measures that will be performed prior to each Winter Period, and site-specific interim measures that will be performed prior to the Winter Period until permanent, prescribed treatments can be executed.

- 5.2. Describe maintenance of all drainage or sediment capture features (e.g., drainage culverts, drainage trenches, settling ponds, etc.) to remove debris, soil blockages, and ensure adequate capacity exists.

Existing drainage structures will be maintained or repaired as feasible and necessary with hand tools during annual winterization and winter monitoring. Prescribed repair and maintenance will be executed in accordance with the Mitigation Report and Treatment Implementation Schedules.

- 5.3. Describe any revegetation activities that will occur either at the beginning or end of the precipitation season.

Not applicable.

- 5.4. If any BPTC measure cannot be completed before the onset of Winter Period, contact the Regional Water Board to establish a compliance schedule.

See the attached Mitigation Report and Treatment Implementation Schedule for site descriptions, treatments, and the implementation schedule.

- 5.5. For Region 1 Dischargers, describe any activities that will be performed to address legacy waste discharge issues. Region 6 Dischargers should consult with Regional Water Board staff to confirm if any other activities in addition to BPTCs are necessary to address legacy waste discharge issues.

Not applicable. No legacy waste discharge issues were identified during the assessment of the property.



Phone: (707) 441-8855 Email: info@shn-engr.com Web: shn-engr.com
812 W. Wabash Avenue, Eureka, CA 95501-2138

Reference: 019149

August 26, 2019

Dejan Petrysevski
Mayers Flat Farm, LLC.
P.O. Box 2114
Redway, CA 95560

Subject: Engineering Geologic Evaluation of Existing Pond Embankment, APN 211-372-006, Myers Flat, Humboldt County, California

Dear Dejan Petrysevski:

This letter provides the results of a recent engineering geologic inspection that SHN conducted of an existing pond at Assessor's parcel number (APN) 211-372-006, off Dyerville Loop Road, near Myers Flat, Humboldt County, California. The intent of our inspection was to evaluate embankment conditions in the context of ongoing permitting at the site for cannabis cultivation. Our task is to provide a professional opinion regarding the integrity of the existing embankment and to define the level of risk of future embankment failure. This is not an assessment of the environmental setting of the ponds relative to watercourses, wetlands, and so on; we understand that others are conducting that assessment as a part of the permitting process.

We note the retroactive assessment of built structures is inherently limited in its effectiveness. Inspection of a finished structure is not a comparable substitute for observation and inspection during construction, and regulatory expectations should be developed accordingly. Post-construction testing can provide localized information relative to the condition of a structure but is of limited utility for evaluation of the structure as a whole. This assessment is, therefore, qualitative and is by nature subjective and based in large part on professional judgment.

We visited the site on July 25, 2019, and conducted a visual reconnaissance of existing site conditions. We evaluated the subject embankment by collecting relevant measurements regarding the geometry of the structure and conducted a thorough reconnaissance of all visible parts of the embankment. Sample collection or testing of subsurface materials within the embankment was not conducted, due to the difficulty in the collection of representative samples and the uncertainty in interpretation of testing results (collection and testing of an adequate number of samples to evaluate embankment stability would be cost prohibitive and is beyond the scope of an investigation of this scale).

We were provided a grading, drainage, and erosion control plan for the pond that Omsberg and Preston produced (2018). The plan shows the subject pond and includes two profiles that allow for the determination of embankment heights and geometries and was supplemented by measurements taken in the field. The pond is described as a "rain catchment" pond, meaning it is not intended to receive surface runoff but rather fill through direct precipitation onto



the pond surface. This assessment does not evaluate the validity of this description. The pond is described on the engineered plans as a 350,000-gallon rain-catchment pond.

Site Description

The subject site is in an upland setting, north of Elk Creek on Elk Mountain, along the South Fork Eel River. The site is accessed from Dyerville Loop Road, near Myers Flat. Latitude and longitude for the site are 40.261913 and -123.787740, respectively. The pond is situated on southwest-sloping ground with moderate gradients, approximately 1,000 feet northwest of Elk Creek. The pond is approximately 150 to 200 feet below an east-west-trending ridge. Slope gradients become less steep at the pond site and become lower downslope. The site surface is vegetated with grasses, while immediately downslope of the pond are oak and fir trees.

Published geologic mapping (Spittler, 1983) indicates the site is underlain by bedrock of the Yager terrane, which is part of the Coastal belt of the Franciscan Complex. Yager terrane bedrock is interpreted as being Tertiary to Cretaceous in age and is described as "*well-consolidated silt-shale, siltstone, sandstone, mudstone, and conglomerate; highly sheared in places.*" Mass wasting in this bedrock material is strongly influenced by the regional bedding (dip slopes, for example, are more susceptible to landsliding) and proximity to large siltstone masses. The area is not associated with landslide-related geomorphic features as depicted on the California Geological Survey map of the Myers Flat quadrangle (Spittler, 1983).

Pond Description

We understand the pond was built in 2015 or 2016. The pond is rectangular and was developed on a low- to moderate-gradient slope at the base of a moderately-steep hillslope. A cut slope was constructed on the northeast side of the pond with gradients ranging from 30 to 50 percent. The pond embankment extends away from the cut slope, to the southwest. Bedrock and rocky soils are exposed at the surface in the cut slope. The pond is lined with an HDPE liner, which Omsberg and Preston indicate is 30-mil-thick. The liner extends over the embankment crest and is embedded into the embankment fill soils. It appears as though the pond and embankment were constructed with gravelly Yager formation materials. The embankment crest widths range from approximately 7 to 18 feet, and embankment heights (on the downhill side) range from approximately 12 to 17 feet. The embankment is vegetated with grasses.

The pond has a spillway consisting of a 12-inch-wide, 170-foot-long corrugated plastic overflow pipe that is built into the embankment at the southern corner. The overflow pipe is underlain by the pond liner and is covered with up to 2 feet of soil. The outlet for the overflow pipe daylights approximately 70 feet downslope of the embankment and is armored with up to 1 cubic yard of aggregate rock for erosion control/energy dissipation. The spillway appears to provide up to about 2 feet of freeboard. Slope gradients on the embankment faces (both interior and exterior) are on the order of 40 to 45 percent (22 to 24 degrees), which are equivalent to gradients ranging from 2.25:1 horizontal:vertical (H:V) and 2.5:1 H:V. The embankment slopes are generally smooth and appear to have been well built. There were no signs of seepage or throughflow of the embankment at the time of our visit.



A small erosion scar was observed on the embankment. The erosion scar is in the northwest portion on the downhill embankment. A representative from Humble Servants of the Mattole reported the scar was generated due to a small leak from an irrigation pipe. Once the leak was identified, the irrigation pipe was removed and subsequently, the erosion scar did not become any larger. The erosion scar is approximately 4 to 7 inches deep and up to 24 inches wide.

Conclusions

The embankment for the subject pond appears well-built and well-maintained, and the pond appears to be located in a suitable geologic setting. The embankment appears to have been built using industry-standard geometry, with appropriate widths, side slopes, and a suitable spillway that provides sufficient freeboard. No seepage was observed, and no signs of distress (fissuring and so on) were noted.

The minor erosion scar on the embankment does not appear significant enough to impact the structural integrity of the embankment or embankment stability and does not require short-term repair.

Based on the inspection conducted in 2019, we conclude this pond is associated with a low failure potential and a low potential for environmental impacts related to the geotechnical conditions at the site.

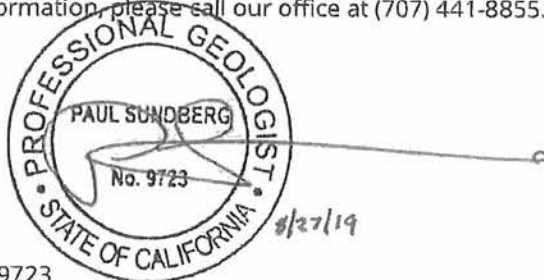
Closure

The evaluation described herein is a focused investigation limited by the nature of retroactive inspections of built structures. Because we did not observe the construction of the subject embankment nor were we provided any information regarding construction methods, we were only able to evaluate visible portions of the structure. In these situations, we take a conservative approach to assessment of the embankment, and document signs of potential distress or apparent points of weakness. Due to the limitations of this approach, it is important to regularly monitor the embankment for signs of change that may suggest the need for repairs or improvements.

We hope this evaluation provides the information you need at this time. If you have any questions or require additional information, please call our office at (707) 441-8855.

Sincerely,

SHN



Paul R. Sundberg, PG 9723
Project Geologist

PRS:GDS:ame



Dejan Petrysevski

Engineering Geologic Evaluation of Existing Pond Embankment, APN 211-372-006, Myers Flat

August 26, 2019

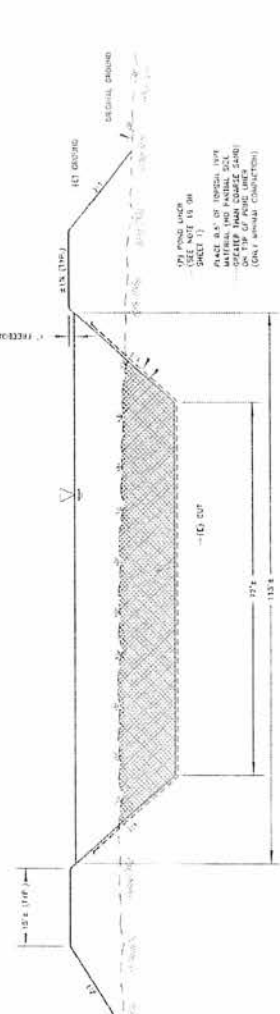
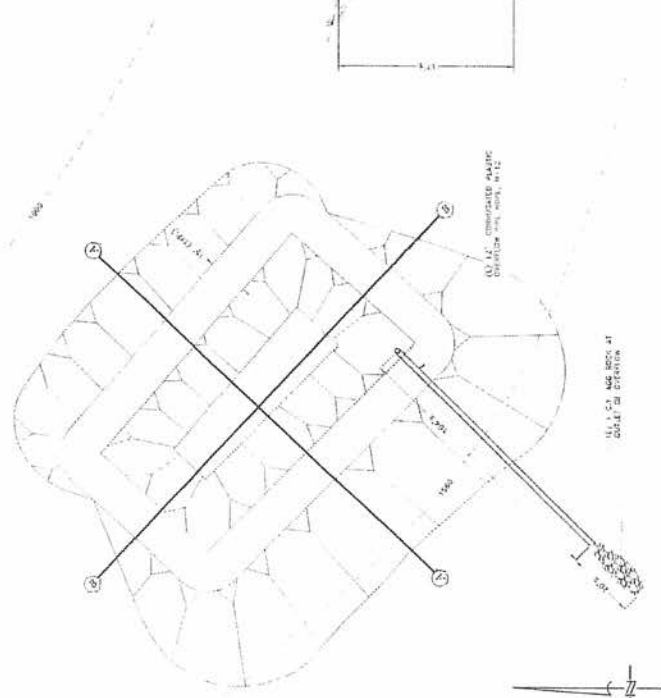
Page 4

References

Omsberg and Preston. (2018). Grading, Drainage and Erosion Control Plan for Antonio Petrysevski. APN 211-372-006.

Spittler, T. (1983). Geology and Geomorphic Features Related to Landsliding, Myers Flat Quadrangle, Humboldt County, California. California Division of Mines and Geology Open-file Report OFR 83-22 SF. Scale 1:24,000.





NO.	DATE	BY	REVISION
1	04/20/24	ANTONIO PEREIRA/SKI	ISSUED FOR PERMIT
2			
3			

PROJECT NO. 211-572-006

DATE: 04/20/24

BY: ANTONIO PEREIRA/SKI

FOR: SUBMITTAL TO THE CITY OF TAMPA

PROJECT: TAMPA SKI CENTER

SCALE: 1" = 40'

DATE: 04/20/24

BY: ANTONIO PEREIRA/SKI

FOR: SUBMITTAL TO THE CITY OF TAMPA

PROJECT: TAMPA SKI CENTER

WETLAND DELINEATION

Dejan Petrushevski (APN: 211-372-006)

Humboldt County, CA

Prepared by:

Kyle Wear
Botanical Consultant
kyle_wear@suddenlink.net
(707) 601-1725

Prepared for:

Timberland Resource Consultants
165 South Fortuna Blvd.
Fortuna, CA 95540

Date:

January 2019

1. INTRODUCTION

The purpose of this study was to identify and delineate wetlands on APN: 211-372-006 near Miranda that could be impacted by commercial cannabis cultivation.

2. WETLAND DEFINITIONS

The Army Corps of Engineers defines wetlands as:

“...areas that are inundated or saturated by surface or ground water at a frequency and duration sufficient to support, and that under normal conditions do support, a prevalence of vegetation typically adapted for life in saturated soil conditions. Wetlands generally include swamps, marshes, bogs, and similar areas.”

The State Water Board defines wetlands as:

"An area that is covered by shallow water or where the surface soil is saturated, either year round or during periods of the year; Where that water coverage has caused a lack of oxygen in the surface soil; And has either no vegetation or plants of a type that have adapted to shallow water or saturated soil. Some examples are fresh water marshes, bogs, riparian areas, vernal pools, coastal mud flats and salt marshes."

3. PROJECT AREA DESCRIPTION

Location

The parcel is located at off Dyerville Loop Road approximately 2.5 northeast of Miranda (Section 25, T2S, R3E).

Vegetation

The vegetation in the study area includes non-native grasslands, emergent wetland dominated by and rushes (*Juncus* spp.), and Douglas-fir forest. Oaks (*Quercus* spp.) are often present.

Soil

The soil mapped in the study area is Yorknorth-Windynip complex (USDA, NRCS 2019). This loamy soil is derived from sandstone, mudstone, schist, and earthflow deposits.

Hydrology

The streams and wetlands on the parcel drain into Elk Creek a tributary to the South Fork Eel River.

4. METHODS

Four representative sample plots were evaluated for hydrophytic vegetation, hydric soil, and wetland hydrology using methods described in the *Regional Supplement to the Corps of Engineers Wetland Delineation Manual Western Mountains, Valleys, and Coast Region (Version 2.0)* (Army Corps 2010) and the *1987 Corps of Engineers Wetlands Delineation Manual* (Environmental Laboratory 1987). The plots represented the variation in vegetation and topography within the wetland and adjacent upland habitat. The wetland determination field data forms are provided in Appendix A. A positive wetland determination is made when all three wetland parameters are present (hydrophytic vegetation, hydric soil, and wetland hydrology).

Field work was conducted by Kyle Wear, M.A., on December 21, 2018 and January 10, 2019. Mr. Wear is a professional botanist and is trained in wetland delineation by the Wetland Training Institute. Mr. Wear has been conducting wetland delineations for over ten years throughout northern California.

Hydrophytic Vegetation

The presence of hydrophytic vegetation is determined by recording the wetland indicator status of each plant species present using the *Western Mountains Valleys and Coast 2016 Regional Wetland Plant List* (Army Corps 2016). The indicator status of plants is based on the estimated probability of the species occurring in wetlands. The indicator status categories are:

Obligate Wetland Plants (OBL)	Almost always occur in wetlands	>99% frequency
Facultative Wetland Plants (FACW)	Usually occur in wetlands	67%-99%
Facultative Plants (FAC)	Equally occur wetlands and non-wetlands	33%-67%
Facultative Upland Plants (FACU)	Sometimes occur in wetlands	1%-33%
Obligate Upland Plants (UPL)	Rarely occur in wetlands	<1%

If more than 50% of the dominant plants across all vegetation strata (i.e. trees, shrubs, herbs) are OBL, FACW, or FAC, the vegetation is hydrophytic. Dominance of plants within the plots is determined using the "50/20" rule. This method involves estimating absolute cover of each plant in each vegetation stratum. Dominant plants include the plants with the highest cover that collectively, or individually account for 50% of the total vegetation cover. Additional plants are considered dominant if their cover is at least 20% of the total cover.

Hydric Soil

Indicators of hydric soil include, but are not limited to, a strong hydrogen sulfide (rotten egg) odor, redox concentrations, depleted matrix, and high organic matter content. Soil colors were determined by using a Munsell soil color chart (Gretag Macbeth 2000).

Wetland Hydrology

Indicators of wetland hydrology include, but are not limited to, surface water, high water table, soil saturation, sediment deposits, soil cracks, and oxidized root channels along living roots.

5. RESULTS AND DISCUSSION

Approximately 1.74 acres of emergent wetland were identified in the vicinity of the cannabis cultivation infrastructure (Figure 1). One wetland on the parcel is identified in the *National Wetlands Inventory* (USFWS 2019) and in the *Humboldt County Web GIS* application (Humboldt County 2019).

Hydrophytic Vegetation

Dominant plants in the wetlands include rushes (*Juncus patens* [FACW] and *J. effusus* [FACW]) and pennyroyal (*Mentha pelugium* [OBL]). The adjacent upland grasslands are often dominated by harding grass (*Phalaris aquatica* [FACU]), seaside barenly (*Hordeum marinum* [FAC]), dogtail grass (*Cynosurus echinatus* [UPL]), and blue wild rye (*Elymus glaucus* [FACU]). Because of the timing of the field work in winter, there were several grasses that were not identifiable and likely annual grasses and other herbaceous plants not detectable. The grasslands often include stands of bracken fern (*Pteridium aquilinum* [FACU]). The adjacent forests are often dominated by Douglas fir (*Pseudotsuga menziesii* [FACU]) and canyon live oak (*Quercus chrysolepis* [UPL]).

Hydric Soil

Hydric soil observed in the wetlands met indicator F6 (Redox Dark Surface). Soils were generally 10yr 3/1 with approximately 10% 7.5yr 5/6 redox concentrations. Upland soils were generally 10yr 2/2 and lacked redox concentrations.

Wetland Hydrology

The study was conducted after a period of slightly lower than normal rainfall. Wetland hydrology indicators present in the wetlands included A1 (Surface Water), A2 (High Water Table), and A3 (Saturation). Upland areas lacked a water table or soil saturation within 12 inches of the surface. The culvert draining the roadside ditch onto the hillslope at Cultivation Site 1 was flowing onto the hillslope on January 10th.

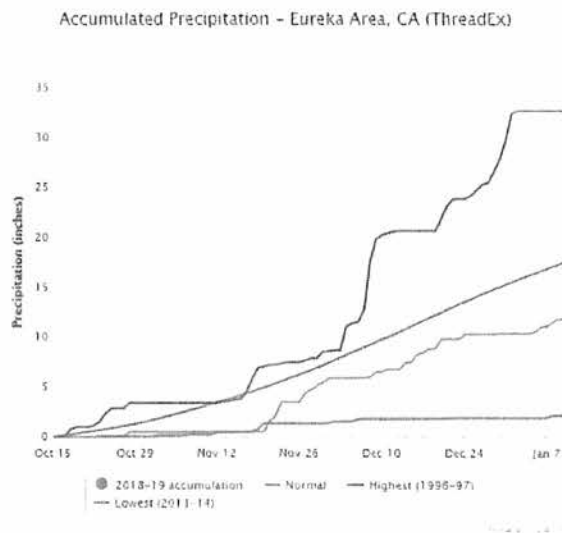
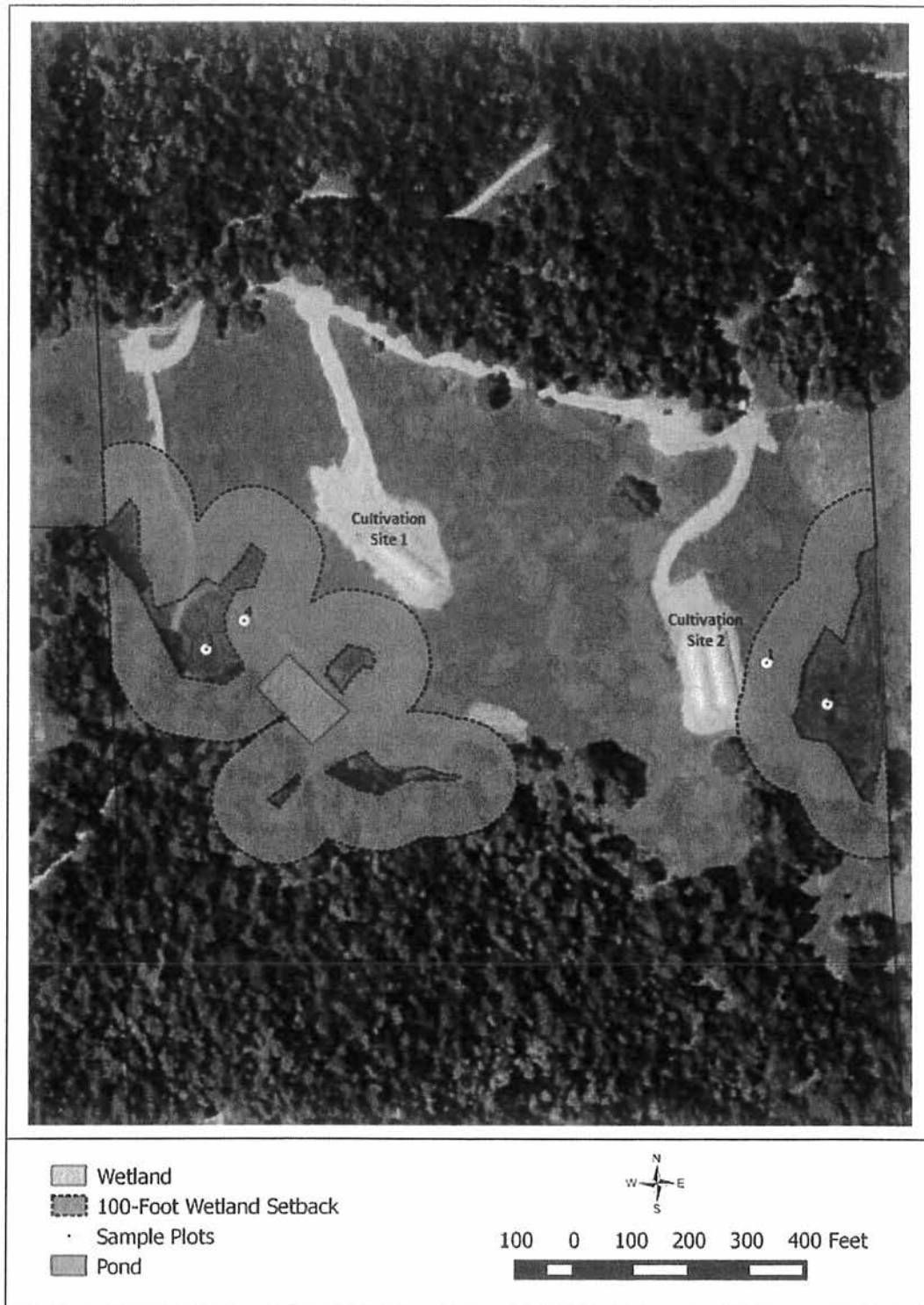


Figure 1. Wetland Delineation Map.



6. REFERENCES

Environmental Laboratory. 1987. *Corps of Engineers Wetlands Delineation Manual*. Technical Report Y-87-1. Vicksburg, MS: U.S. Army Engineer Waterways Experimental Station.

GretagMacbeth. 2000. *Munsell Soil Color Charts*. New Winsdor, NY

Humboldt County 2019. Humboldt County Web GIS
<http://webgis.co.humboldt.ca.us/HCEGIS2.0/>

U.S. Army Corps of Engineers (Army Corps). 2016. *Western Mountains, Valleys, and Coast 2016 Regional Wetland Plant List*. Lichvar, R.W., D.L. Banks, and N.C. Melvin. The National Wetland Plant List: 2016 Update of Wetland Ratings. *Phytoneuron* 2016-30: 1-17.

U.S. Army Corps of Engineers (Army Corps). 2010. *Regional Supplement to the Corps of Engineers Wetland Delineation Manual. Western Mountains, Valleys, and Coast Region (Version 2.0)*, ed. J. S. Wakeley, R. W. Lichvar, and C. V. Noble. ERDC/EI TR-10-3. Vicksburg, MS. Army Corps of Engineer Research and Development Center.

U.S. Fish and Wildlife Service (USFWS). 2019. National Wetlands Inventory.
<https://www.fws.gov/wetlands/>

United States Department of Agriculture, Natural Resource Conservation Service (USDA, NRCS). 2019. *Web Soil Survey*.
<https://websoilsurvey.sc.egov.usda.gov>

Appendix A. Field Data Forms.

WETLAND DETERMINATION DATA FORM – Western Mountains, Valleys, and Coast Region

Project/Site: APN 211-372-006 City/County: Humboldt Sampling Date: 12-21-18
 Applicant/Owner: D. Petrushevski State: CA Sampling Point: 1
 Investigator(s): K. Wear Section, Township, Range: 25, T2S, R3E
 Landform (hillslope terrace, etc.): _____ Local relief (concave, convex, none): _____ Slope (%): 10
 Subregion (LRR): A Lat: E 433262.5 Long: N 4457148.6 Datum: NAD83
 Soil Map Unit Name: York-north-Windypip NWI classification: _____
 Are climatic / hydrologic conditions on the site typical for this time of year? Yes No _____ (If no, explain in Remarks.)
 Are Vegetation _____, Soil _____, or Hydrology _____ significantly disturbed? Are "Normal Circumstances" present? Yes No _____
 Are Vegetation _____, Soil _____, or Hydrology _____ naturally problematic? (If needed, explain any answers in Remarks.)

SUMMARY OF FINDINGS – Attach site map showing sampling point locations, transects, important features, etc.

Hydrophytic Vegetation Present?	Yes _____ No <input checked="" type="checkbox"/>	Is the Sampled Area within a Wetland?	Yes _____ No <input checked="" type="checkbox"/>
Hydric Soil Present?	Yes _____ No <input checked="" type="checkbox"/>		
Wetland Hydrology Present?	Yes _____ No <input checked="" type="checkbox"/>		
Remarks:			

VEGETATION – Use scientific names of plants.

Tree Stratum (Plot size: _____)	Absolute % Cover	Dominant Species?	Indicator Status	Dominance Test worksheet:	
1. _____				Number of Dominant Species That Are OBL, FACW, or FAC: <u>0</u> (A)	
2. _____				Total Number of Dominant Species Across All Strata: <u>3</u> (B)	
3. _____				Percent of Dominant Species That Are OBL, FACW, or FAC: <u>0</u> (A/B)	
4. _____				Prevalence Index worksheet:	
= Total Cover				Total % Cover of:	Multiply by:
Saoping/Shrub Stratum (Plot size: _____)				OBL species _____ x 1 = _____	
1. _____				FACW species _____ x 2 = _____	
2. _____				FAC species _____ x 3 = _____	
3. _____				FACU species _____ x 4 = _____	
4. _____				UPL species _____ x 5 = _____	
5. _____				Column Totals: _____ (A) _____ (B)	
= Total Cover				Prevalence Index = B/A = _____	
Herb Stratum (Plot size: <u>10'</u> -radius)				Hydrophytic Vegetation Indicators:	
1. Hydrophytic				___ 1 - Rapid Test for Hydrophytic Vegetation	
2. _____				___ 2 - Dominance Test is >50%	
3. <u>Pteridium aquilinum</u>	<u>20</u>	<u>Y</u>	<u>FACU</u>	___ 3 - Prevalence Index is ≤3.0 ¹	
4. <u>Elymus glaucus</u>	<u>20</u>	<u>Y</u>	<u>FACU</u>	___ 4 - Morphological Adaptations ¹ (Provide supporting data in Remarks or on a separate sheet)	
5. <u>Cynodon dactylon</u>	<u>20</u>	<u>Y</u>	<u>UPL</u>	___ 5 - Wetland Non-Vascular Plants ¹	
6. <u>Rumex crispus</u>	<u>10</u>	<u>N</u>	<u>FAC</u>	___ Problematic Hydrophytic Vegetation ¹ (Explain)	
7. <u>Cirsium vulgare</u>	<u>2</u>	<u>N</u>	<u>FACU</u>	¹ Indicators of hydric soil and wetland hydrology must be present, unless disturbed or problematic.	
8. <u>Hypericum perforatum</u>	<u>5</u>	<u>N</u>	<u>FACU</u>		
9. <u>Other non-flowering/non</u>	<u>10</u>	<u>N</u>	<u>?</u>		
10. <u>Wetland-grasses</u>					
11. _____					
= Total Cover				Hydrophytic Vegetation Present? Yes _____ No <input checked="" type="checkbox"/>	
Woody Vine Stratum (Plot size: _____)					
1. _____					
2. _____					
= Total Cover					
% Bare Ground in Herb Stratum _____					
Remarks:					

SOIL

Sampling Point: 1

Profile Description: (Describe to the depth needed to document the indicator or confirm the absence of indicators.)

Depth (inches)	Matrix		Redox Features				Texture	Remarks
	Color (moist)	%	Color (moist)	%	Type ¹	Loc ²		
0-12	10YR 2/2							

¹Type: C=Concentration, D=Depletion, RM=Reduced Matrix, CS=Covered or Coated Sand Grains. ²Location: PL=Pore Lining, M=Matrix.

Hydric Soil Indicators: (Applicable to all LRRs, unless otherwise noted.)

<input type="checkbox"/> Histosol (A1)	<input type="checkbox"/> Sandy Redox (S5)	<input type="checkbox"/> 2 cm Muck (A10)
<input type="checkbox"/> Histic Epipedon (A2)	<input type="checkbox"/> Stripped Matrix (S6)	<input type="checkbox"/> Red Parent Material (TF2)
<input type="checkbox"/> Black Histic (A3)	<input type="checkbox"/> Loamy Mucky Mineral (F1) (except MLRA 1)	<input type="checkbox"/> Very Shallow Dark Surface (TF12)
<input type="checkbox"/> Hydrogen Sulfide (A4)	<input type="checkbox"/> Loamy Gleyed Matrix (F2)	<input type="checkbox"/> Other (Explain in Remarks)
<input type="checkbox"/> Depleted Below Dark Surface (A11)	<input type="checkbox"/> Depleted Matrix (F3)	
<input type="checkbox"/> Thick Dark Surface (A12)	<input type="checkbox"/> Redox Dark Surface (F6)	
<input type="checkbox"/> Sandy Mucky Mineral (S1)	<input type="checkbox"/> Depleted Dark Surface (F7)	
<input type="checkbox"/> Sandy Gleyed Matrix (S4)	<input type="checkbox"/> Redox Depressions (F8)	

Indicators for Problematic Hydric Soils³:

³Indicators of hydrophytic vegetation and wetland hydrology must be present, unless disturbed or problematic.

Restrictive Layer (if present):

Type: _____

Depth (inches): _____

Hydric Soil Present? Yes _____ No

Remarks:

HYDROLOGY

Wetland Hydrology Indicators:

<u>Primary Indicators (minimum of one required: check all that apply)</u>		<u>Secondary Indicators (2 or more required)</u>
<input type="checkbox"/> Surface Water (A1)	<input type="checkbox"/> Water-Stained Leaves (B9) (except MLRA 1, 2, 4A, and 4B)	<input type="checkbox"/> Water-Stained Leaves (B9) (MLRA 1, 2, 4A, and 4B)
<input type="checkbox"/> High Water Table (A2)	<input type="checkbox"/> Salt Crust (B11)	<input type="checkbox"/> Drainage Patterns (B10)
<input type="checkbox"/> Saturation (A3)	<input type="checkbox"/> Aquatic Invertebrates (B13)	<input type="checkbox"/> Dry-Season Water Table (C2)
<input type="checkbox"/> Water Marks (B1)	<input type="checkbox"/> Hydrogen Sulfide Odor (C1)	<input type="checkbox"/> Saturation Visible on Aerial Imagery (C9)
<input type="checkbox"/> Sediment Deposits (B2)	<input type="checkbox"/> Oxidized Rhizospheres along Living Roots (C3)	<input type="checkbox"/> Geomorphic Position (D2)
<input type="checkbox"/> Drift Deposits (B3)	<input type="checkbox"/> Presence of Reduced Iron (C4)	<input type="checkbox"/> Shallow Aquitard (D3)
<input type="checkbox"/> Algal Mat or Crust (B4)	<input type="checkbox"/> Recent Iron Reduction in Tilled Soils (C6)	<input type="checkbox"/> FAC-Neutral Test (D5)
<input type="checkbox"/> Iron Deposits (B5)	<input type="checkbox"/> Stunted or Stressed Plants (D1) (LRR A)	<input type="checkbox"/> Raised Ant Mounds (D6) (LRR A)
<input type="checkbox"/> Surface Soil Cracks (B6)	<input type="checkbox"/> Other (Explain in Remarks)	<input type="checkbox"/> Frost-Heave Hummocks (D7)
<input type="checkbox"/> Inundation Visible on Aerial Imagery (B7)		
<input type="checkbox"/> Sparsely Vegetated Concave Surface (B8)		

Field Observations:

Surface Water Present?	Yes _____ No <input checked="" type="checkbox"/>	Depth (inches): _____	Wetland Hydrology Present? Yes _____ No <input checked="" type="checkbox"/>
Water Table Present?	Yes _____ No <input checked="" type="checkbox"/>	Depth (inches): _____	
Saturation Present? (includes capillary fringe)	Yes _____ No <input checked="" type="checkbox"/>	Depth (inches): _____	

Describe Recorded Data (stream gauge, monitoring well, aerial photos, previous inspections), if available:

Remarks:

A-2

WETLAND DETERMINATION DATA FORM – Western Mountains, Valleys, and Coast Region

Project/Site: APN 211-372-006 City/County: Humboldt Sampling Date: 12-21-18
 Applicant/Owner: D. Petrushevski State: CA Sampling Point: 2
 Investigator(s): K. Wear Section, Township, Range: 25, T2S, R3E
 Landform (hillslope, terrace, etc.): _____ Local relief (concave, convex, none): _____ Slope (%): 2
 Subregion (LRR): A Lat: E 433296.6 Long: N 4457126.7 Datum: NAD 83
 Soil Map Unit Name: Yorknath - Windyrip NWI classification: PEM~~1~~ 1B
 Are climatic / hydrologic conditions on the site typical for this time of year? Yes No _____ (If no, explain in Remarks.)
 Are Vegetation _____, Soil _____, or Hydrology _____ significantly disturbed? Are "Normal Circumstances" present? Yes No _____
 Are Vegetation _____, Soil _____, or Hydrology _____ naturally problematic? (If needed, explain any answers in Remarks.)

SUMMARY OF FINDINGS – Attach site map showing sampling point locations, transects, important features, etc.

Hydrophytic Vegetation Present?	Yes <input checked="" type="checkbox"/>	No _____	Is the Sampled Area within a Wetland?	Yes <input checked="" type="checkbox"/>	No _____
Hydric Soil Present?	Yes <input checked="" type="checkbox"/>	No _____			
Wetland Hydrology Present?	Yes <input checked="" type="checkbox"/>	No _____			
Remarks:					

VEGETATION – Use scientific names of plants.

Tree Stratum (Plot size: _____)	Absolute % Cover	Dominant Species?	Indicator Status	Dominance Test worksheet:	
1. _____	_____	_____	_____	Number of Dominant Species That Are OBL, FACW, or FAC:	<u>3</u> (A)
2. _____	_____	_____	_____	Total Number of Dominant Species Across All Strata:	<u>3</u> (B)
3. _____	_____	_____	_____	Percent of Dominant Species That Are OBL, FACW, or FAC:	<u>100</u> (A/B)
4. _____	_____	_____	_____	Prevalence Index worksheet:	
_____ = Total Cover					
Sapling/Shrub Stratum (Plot size: _____)				Total % Cover of: _____ Multiply by: _____	
1. _____	_____	_____	_____	OBL species _____	x 1 = _____
2. _____	_____	_____	_____	FACW species _____	x 2 = _____
3. _____	_____	_____	_____	FAC species _____	x 3 = _____
4. _____	_____	_____	_____	FACU species _____	x 4 = _____
5. _____	_____	_____	_____	UPL species _____	x 5 = _____
_____ = Total Cover				Column Totals:	_____ (A) _____ (B)
Herb Stratum (Plot size: <u>10' - radius</u>)				Prevalence Index = B/A = _____	
1. <u>Juncus patens</u>	<u>20</u>	<u>Y</u>	<u>FACW</u>	Hydrophytic Vegetation Indicators: <input checked="" type="checkbox"/> 1 - Rapid Test for Hydrophytic Vegetation _____ 2 - Dominance Test is >50% _____ 3 - Prevalence Index is ≤3.0 ¹ _____ 4 - Morphological Adaptations ¹ (Provide supporting data in Remarks or on a separate sheet) _____ 5 - Wetland Non-Vascular Plants ¹ _____ Problematic Hydrophytic Vegetation ¹ (Explain) ¹ Indicators of hydric soil and wetland hydrology must be present, unless disturbed or problematic.	
2. <u>Carex sp. (looks like C. gynodiana)</u>	<u>20</u>	<u>Y</u>	<u>FACW or OBL?</u>		
3. _____	_____	_____	_____		
4. _____	_____	_____	_____		
5. <u>Mentha pulegium</u>	<u>20</u>	<u>Y</u>	<u>OBL</u>		
6. <u>Phalaris aquatica + other</u>	<u>20</u>	<u>N</u>	<u>?</u>		
7. <u>dead grasses</u>	_____	_____	_____		
8. _____	_____	_____	_____		
9. _____	_____	_____	_____		
10. _____	_____	_____	_____		
11. _____	_____	_____	_____		
_____ = Total Cover				Hydrophytic Vegetation Present? Yes <input checked="" type="checkbox"/> No _____	
Woody Vine Stratum (Plot size: _____)					
1. _____	_____	_____	_____	Hydrophytic Vegetation Present? Yes <input checked="" type="checkbox"/> No _____	
2. _____	_____	_____	_____		
% Bare Ground in Herb Stratum _____				_____ = Total Cover	
Remarks:					

SOIL

Sampling Point: 2

Profile Description: (Describe to the depth needed to document the indicator or confirm the absence of indicators.)

Depth (inches)	Matrix		Redox Features				Texture	Remarks
	Color (moist)	%	Color (moist)	%	Type ¹	Loc ²		
<u>0-2</u>	<u>10Y 3/1</u>	<u>90</u>	<u>7.5Yr 5/6</u>	<u>10</u>	<u>C</u>	<u>M</u>	<u>CL</u>	

¹Type: C=Concentration, D=Depletion, RM=Reduced Matrix, CS=Covered or Coated Sand Grains. ²Location: PL=Pore Lining, M=Matrix.

Hydic Soil Indicators: (Applicable to all LRRs, unless otherwise noted.)

<input type="checkbox"/> Histosol (A1)	<input type="checkbox"/> Sandy Redox (S5)	<input type="checkbox"/> 2 cm Muck (A10)
<input type="checkbox"/> Histic Epipedon (A2)	<input type="checkbox"/> Stripped Matrix (S6)	<input type="checkbox"/> Red Parent Material (TF2)
<input type="checkbox"/> Black Histic (A3)	<input type="checkbox"/> Loamy Mucky Mineral (F1) (except MLRA 1)	<input type="checkbox"/> Very Shallow Dark Surface (TF12)
<input type="checkbox"/> Hydrogen Sulfide (A4)	<input type="checkbox"/> Loamy Gleyed Matrix (F2)	<input type="checkbox"/> Other (Explain in Remarks)
<input type="checkbox"/> Depleted Below Dark Surface (A11)	<input type="checkbox"/> Depleted Matrix (F3)	
<input type="checkbox"/> Thick Dark Surface (A12)	<input checked="" type="checkbox"/> Redox Dark Surface (F6)	
<input type="checkbox"/> Sandy Mucky Mineral (S1)	<input type="checkbox"/> Depleted Dark Surface (F7)	
<input type="checkbox"/> Sandy Gleyed Matrix (S4)	<input type="checkbox"/> Redox Depressions (F8)	

Indicators for Problematic Hydric Soils³:

³Indicators of hydrophytic vegetation and wetland hydrology must be present, unless disturbed or problematic.

Restrictive Layer (if present):
 Type: _____
 Depth (inches): _____

Hydic Soil Present? Yes No

Remarks:

HYDROLOGY

Wetland Hydrology Indicators:

<u>Primary Indicators (minimum of one required; check all that apply)</u>		<u>Secondary Indicators (2 or more required)</u>
<input checked="" type="checkbox"/> Surface Water (A1)	<input type="checkbox"/> Water-Stained Leaves (B9) (except MLRA 1, 2, 4A, and 4B)	<input type="checkbox"/> Water-Stained Leaves (B9) (MLRA 1, 2, 4A, and 4B)
<input checked="" type="checkbox"/> High Water Table (A2)	<input type="checkbox"/> Salt Crust (B11)	<input type="checkbox"/> Drainage Patterns (B10)
<input checked="" type="checkbox"/> Saturation (A3)	<input type="checkbox"/> Aquatic Invertebrates (B13)	<input type="checkbox"/> Dry-Season Water Table (C2)
<input type="checkbox"/> Water Marks (B1)	<input type="checkbox"/> Hydrogen Sulfide Odor (C1)	<input type="checkbox"/> Saturation Visible on Aerial Imagery (C9)
<input type="checkbox"/> Sediment Deposits (B2)	<input type="checkbox"/> Oxidized Rhizospheres along Living Roots (C3)	<input type="checkbox"/> Geomorphic Position (D2)
<input type="checkbox"/> Drift Deposits (B3)	<input type="checkbox"/> Presence of Reduced Iron (C4)	<input type="checkbox"/> Shallow Aquitard (D3)
<input type="checkbox"/> Algal Mat or Crust (B4)	<input type="checkbox"/> Recent Iron Reduction in Tilled Soils (C6)	<input type="checkbox"/> FAC-Neutral Test (D5)
<input type="checkbox"/> Iron Deposits (B5)	<input type="checkbox"/> Stunted or Stressed Plants (D1) (LRR A)	<input type="checkbox"/> Raised Ant Mounds (D6) (LRR A)
<input type="checkbox"/> Surface Soil Cracks (B6)	<input type="checkbox"/> Other (Explain in Remarks)	<input type="checkbox"/> Frost-Heave Hummocks (D7)
<input type="checkbox"/> Inundation Visible on Aerial Imagery (B7)		
<input type="checkbox"/> Sparsely Vegetated Concave Surface (B8)		

Field Observations:

Surface Water Present?	Yes <input checked="" type="checkbox"/> No <input type="checkbox"/>	Depth (inches): <u>①</u>	Wetland Hydrology Present? Yes <input checked="" type="checkbox"/> No <input type="checkbox"/>
Water Table Present?	Yes <input checked="" type="checkbox"/> No <input type="checkbox"/>	Depth (inches): _____	
Saturation Present? (includes capillary fringe)	Yes <input checked="" type="checkbox"/> No <input type="checkbox"/>	Depth (inches): _____	

Describe Recorded Data (stream gauge, monitoring well, aerial photos, previous inspections), if available:

Remarks: Areas of ~~shallow~~ shallow surface water + areas with ground water + saturation at the surface in plot.

WETLAND DETERMINATION DATA FORM – Western Mountains, Valleys, and Coast Region

Project/Site: APW 211-372-006 City/County: Humboldt Sampling Date: 12-21-18
 Applicant/Owner: D. Petrushevski State: CA Sampling Point: 3
 Investigator(s): K. Wear Section, Township, Range: 2S, T2S, R3E
 Landform (hillslope, terrace, etc.): _____ Local relief (concave, convex, none): _____ Slope (%): 2
 Subregion (LRR): A E 432965.8 N 4457155.4 Datum: NAD 83
 Soil Map Unit Name: Yurkharth - Windyrip NWI classification: _____
 Are climatic / hydrologic conditions on the site typical for this time of year? Yes No _____ (If no, explain in Remarks.)
 Are Vegetation _____, Soil _____, or Hydrology _____ significantly disturbed? Are "Normal Circumstances" present? Yes No _____
 Are Vegetation _____, Soil _____, or Hydrology _____ naturally problematic? (If needed, explain any answers in Remarks.)

SUMMARY OF FINDINGS – Attach site map showing sampling point locations, transects, important features, etc.

Hydrophytic Vegetation Present?	Yes <input checked="" type="checkbox"/>	No _____	Is the Sampled Area within a Wetland? Yes <input checked="" type="checkbox"/> No _____
Hydric Soil Present?	Yes <input checked="" type="checkbox"/>	No _____	
Wetland Hydrology Present?	Yes <input checked="" type="checkbox"/>	No _____	
Remarks:			

VEGETATION – Use scientific names of plants.

Tree Stratum (Plot size: _____)	Absolute % Cover	Dominant Species?	Indicator Status	Dominance Test worksheet:
1. _____	_____	_____	_____	Number of Dominant Species That Are OBL, FACW, or FAC: <u>3</u> (A)
2. _____	_____	_____	_____	Total Number of Dominant Species Across All Strata: <u>3</u> (B)
3. _____	_____	_____	_____	Percent of Dominant Species That Are OBL, FACW, or FAC: <u>100</u> (A/B)
4. _____	_____	_____	_____	Prevalence Index worksheet: Total % Cover of: _____ Multiply by: OBL species _____ x 1 = _____ FACW species _____ x 2 = _____ FAC species _____ x 3 = _____ FACU species _____ x 4 = _____ UPL species _____ x 5 = _____ Column Totals: _____ (A) _____ (B) Prevalence Index = B/A = _____
= Total Cover				
Sapling/Shrub Stratum (Plot size: _____)				
1. _____	_____	_____	_____	
2. _____	_____	_____	_____	
= Total Cover				
Herb Stratum (Plot size: <u>10'-radius</u>)				
1. <u>Juncus effusus</u>	<u>30</u>	<input checked="" type="checkbox"/>	<u>FACW</u>	Hydrophytic Vegetation Indicators: <input checked="" type="checkbox"/> 1 - Rapid Test for Hydrophytic Vegetation ___ 2 - Dominance Test is >50% ___ 3 - Prevalence Index is ≤3.0 ¹ ___ 4 - Morphological Adaptations ¹ (Provide supporting data in Remarks or on a separate sheet) ___ 5 - Wetland Non-Vascular Plants ¹ ___ Problematic Hydrophytic Vegetation ¹ (Explain) ¹ Indicators of hydric soil and wetland hydrology must be present, unless disturbed or problematic.
2. <u>Juncus patens</u>	<u>30</u>	<input checked="" type="checkbox"/>	<u>FACW</u>	
3. <u>Mentha pulegium</u>	<u>10</u>	<input checked="" type="checkbox"/>	<u>FACU</u>	
4. <u>Phalaris aquatica</u>	<u>5</u>	<input checked="" type="checkbox"/>	<u>FACU</u>	
5. <u>Madia sp?</u>	<u>5</u>	<input checked="" type="checkbox"/>	<u>?</u>	
6. _____	_____	_____	_____	
7. _____	_____	_____	_____	
8. _____	_____	_____	_____	
9. _____	_____	_____	_____	
10. _____	_____	_____	_____	
11. _____	_____	_____	_____	
= Total Cover				
Woody Vine Stratum (Plot size: _____)				
1. _____	_____	_____	_____	
2. _____	_____	_____	_____	
= Total Cover				
% Bare Ground in Herb Stratum _____				
Remarks:				

SOIL

Sampling Point: 3

Profile Description: (Describe to the depth needed to document the indicator or confirm the absence of indicators.)

Depth (inches)	Matrix		Redox Features				Texture	Remarks
	Color (moist)	%	Color (moist)	%	Type ¹	Loc ²		
0-12	10yr 3/1	90	7.5yr 5/6	10	c	m	CL	

¹Type: C=Concentration, D=Depletion, RM=Reduced Matrix, CS=Covered or Coated Sand Grains. ²Location: PL=Pore Lining, M=Matrix.

Hydric Soil Indicators: (Applicable to all LRRs, unless otherwise noted.)

<input type="checkbox"/> Histosol (A1)	<input type="checkbox"/> Sandy Redox (S5)	<input type="checkbox"/> 2 cm Muck (A10)
<input type="checkbox"/> Histic Epipedon (A2)	<input type="checkbox"/> Stripped Matrix (S6)	<input type="checkbox"/> Red Parent Material (TF2)
<input type="checkbox"/> Black Histic (A3)	<input type="checkbox"/> Loamy Mucky Mineral (F1) (except MLRA 1)	<input type="checkbox"/> Very Shallow Dark Surface (TF12)
<input type="checkbox"/> Hydrogen Sulfide (A4)	<input type="checkbox"/> Loamy Gleyed Matrix (F2)	<input type="checkbox"/> Other (Explain in Remarks)
<input type="checkbox"/> Depleted Below Dark Surface (A11)	<input type="checkbox"/> Depleted Matrix (F3)	
<input type="checkbox"/> Thick Dark Surface (A12)	<input checked="" type="checkbox"/> Redox Dark Surface (F6)	³ Indicators of hydrophytic vegetation and wetland hydrology must be present, unless disturbed or problematic.
<input type="checkbox"/> Sandy Mucky Mineral (S1)	<input type="checkbox"/> Depleted Dark Surface (F7)	
<input type="checkbox"/> Sandy Gleyed Matrix (S4)	<input type="checkbox"/> Redox Depressions (F8)	

Restrictive Layer (if present):

Type: _____

Depth (inches): _____

Hydric Soil Present? Yes No

Remarks:

HYDROLOGY

Wetland Hydrology Indicators:

<u>Primary Indicators (minimum of one required; check all that apply)</u>		<u>Secondary Indicators (2 or more required)</u>
<input checked="" type="checkbox"/> Surface Water (A1)	<input type="checkbox"/> Water-Stained Leaves (B9) (except MLRA 1, 2, 4A, and 4B)	<input type="checkbox"/> Water-Stained Leaves (B9) (MLRA 1, 2, 4A, and 4B)
<input checked="" type="checkbox"/> High Water Table (A2)	<input type="checkbox"/> Salt Crust (B11)	<input type="checkbox"/> Drainage Patterns (B10)
<input checked="" type="checkbox"/> Saturation (A3)	<input type="checkbox"/> Aquatic Invertebrates (B13)	<input type="checkbox"/> Dry-Season Water Table (C2)
<input type="checkbox"/> Water Marks (B1)	<input type="checkbox"/> Hydrogen Sulfide Odor (C1)	<input type="checkbox"/> Saturation Visible on Aerial Imagery (C9)
<input type="checkbox"/> Sediment Deposits (B2)	<input type="checkbox"/> Oxidized Rhizospheres along Living Roots (C3)	<input type="checkbox"/> Geomorphic Position (D2)
<input type="checkbox"/> Drift Deposits (B3)	<input type="checkbox"/> Presence of Reduced Iron (C4)	<input type="checkbox"/> Shallow Aquitard (D3)
<input type="checkbox"/> Algal Mat or Crust (B4)	<input type="checkbox"/> Recent Iron Reduction in Tilled Soils (C6)	<input type="checkbox"/> FAC-Neutral Test (D5)
<input type="checkbox"/> Iron Deposits (B5)	<input type="checkbox"/> Stunted or Stressed Plants (D1) (LRR A)	<input type="checkbox"/> Raised Ant Mounds (D6) (LRR A)
<input type="checkbox"/> Surface Soil Cracks (B6)	<input type="checkbox"/> Other (Explain in Remarks)	<input type="checkbox"/> Frost-Heave Hummocks (D7)
<input type="checkbox"/> Inundation Visible on Aerial Imagery (B7)		
<input type="checkbox"/> Sparsely Vegetated Concave Surface (B8)		

Field Observations:

Surface Water Present? Yes No Depth (inches): 1"

Water Table Present? Yes No Depth (inches): ± surface

Saturation Present? Yes No Depth (inches): ± surface

(includes capillary fringe)

Wetland Hydrology Present? Yes No

Describe Recorded Data (stream gauge, monitoring well, aerial photos, previous inspections), if available:

Remarks:

WETLAND DETERMINATION DATA FORM – Western Mountains, Valleys, and Coast Region

Project/Site: APW 211-372-006 City/County: Humboldt Sampling Date: 12-21-18
 Applicant/Owner: D. Petrushevski State: CA Sampling Point: 4
 Investigator(s): K. Wear Section, Township, Range: 25, T2S, R3E
 Landform (hillslope, terrace, etc.): _____ Local relief (concave, convex, none): _____ Slope (%): 5
 Subregion (LRR): A E: 432985.9 N: 4457170.6 Datum: NAD83
 Soil Map Unit Name: Yorknarth - Windyrip NWI classification: _____
 Are climatic / hydrologic conditions on the site typical for this time of year? Yes No _____ (If no, explain in Remarks.)
 Are Vegetation _____, Soil _____, or Hydrology _____ significantly disturbed? Are "Normal Circumstances" present? Yes No _____
 Are Vegetation _____, Soil _____, or Hydrology _____ naturally problematic? (If needed, explain any answers in Remarks.)

SUMMARY OF FINDINGS – Attach site map showing sampling point locations, transects, important features, etc.

Hydrophytic Vegetation Present?	Yes _____	No <input checked="" type="checkbox"/>	Is the Sampled Area within a Wetland? Yes _____ No <input checked="" type="checkbox"/>
Hydric Soil Present?	Yes _____	No <input checked="" type="checkbox"/>	
Wetland Hydrology Present?	Yes _____	No <input checked="" type="checkbox"/>	
Remarks:			

VEGETATION – Use scientific names of plants.

Tree Stratum (Plot size: _____)	Absolute % Cover	Dominant Species?	Indicator Status	Dominance Test worksheet:	
1. _____	_____	_____	_____	Number of Dominant Species That Are OBL, FACW, or FAC: <u>1</u> (A)	
2. _____	_____	_____	_____	Total Number of Dominant Species Across All Strata: <u>4</u> (B)	
3. _____	_____	_____	_____	Percent of Dominant Species That Are OBL, FACW, or FAC: <u>25%</u> (A/B)	
4. _____	_____	_____	_____	Prevalence Index worksheet:	
_____ = Total Cover				Total % Cover of: _____ Multiply by: _____	
Sapling/Shrub Stratum (Plot size: _____)				OBL species _____ x 1 = _____	
1. _____	_____	_____	_____	FACW species _____ x 2 = _____	
2. _____	_____	_____	_____	FAC species _____ x 3 = _____	
3. _____	_____	_____	_____	FACU species _____ x 4 = _____	
4. _____	_____	_____	_____	UPL species _____ x 5 = _____	
5. _____	_____	_____	_____	Column Totals: _____ (A) _____ (B)	
_____ = Total Cover				Prevalence Index = B/A = _____	
Herb Stratum (Plot size: <u>10' - radius</u>)				Hydrophytic Vegetation Indicators:	
1. <u>Phalaris aquatica</u>	<u>20</u>	<u>Y</u>	<u>FACU</u>	___ 1 - Rapid Test for Hydrophytic Vegetation	
2. <u>Hordeum marinum</u>	<u>20</u>	<u>Y</u>	<u>FAC</u>	___ 2 - Dominance Test is >50%	
3. <u>Elymus glaucus</u>	<u>10</u>	<u>Y</u>	<u>FACU</u>	___ 3 - Prevalence Index is ≤3.0 ¹	
4. <u>Cynosurus echinatus</u>	<u>10</u>	<u>Y</u>	<u>UPL</u>	___ 4 - Morphological Adaptations ¹ (Provide supporting data in Remarks or on a separate sheet)	
5. <u>Rumex acetosella</u>	<u>5</u>	<u>N</u>	<u>FACU</u>	___ 5 - Wetland Non-Vascular Plants ¹	
6. _____	_____	_____	_____	___ Problematic Hydrophytic Vegetation ¹ (Explain)	
7. _____	_____	_____	_____	¹ Indicators of hydric soil and wetland hydrology must be present, unless disturbed or problematic.	
8. _____	_____	_____	_____	Hydrophytic Vegetation Present? Yes _____ No <input checked="" type="checkbox"/>	
9. _____	_____	_____	_____		
10. _____	_____	_____	_____		
11. _____	_____	_____	_____		
_____ = Total Cover					
Woody Vine Stratum (Plot size: _____)					
1. _____	_____	_____	_____		
2. _____	_____	_____	_____		
_____ = Total Cover					
% Bare Ground in Herb Stratum _____					
Remarks:					

A-7

SOIL

Sampling Point: 4

Profile Description: (Describe to the depth needed to document the indicator or confirm the absence of indicators.)

Depth (inches)	Matrix		Redox Features				Texture	Remarks
	Color (moist)	%	Color (moist)	%	Type ¹	Loc ²		
0-12	10YR 2/2	100					CL	

¹Type: C=Concentration, D=Depletion, RM=Reduced Matrix, CS=Covered or Coated Sand Grains. ²Location: PL=Pore Lining, M=Matrix.

Hydric Soil Indicators: (Applicable to all LRRs, unless otherwise noted.)

<input type="checkbox"/> Histosol (A1)	<input type="checkbox"/> Sandy Redox (S5)	<input type="checkbox"/> 2 cm Muck (A10)
<input type="checkbox"/> Histic Epipedon (A2)	<input type="checkbox"/> Stripped Matrix (S6)	<input type="checkbox"/> Red Parent Material (TF2)
<input type="checkbox"/> Black Histic (A3)	<input type="checkbox"/> Loamy Mucky Mineral (F1) (except MLRA 1)	<input type="checkbox"/> Very Shallow Dark Surface (TF12)
<input type="checkbox"/> Hydrogen Sulfide (A4)	<input type="checkbox"/> Loamy Gleyed Matrix (F2)	<input type="checkbox"/> Other (Explain in Remarks)
<input type="checkbox"/> Depleted Below Dark Surface (A11)	<input type="checkbox"/> Depleted Matrix (F3)	
<input type="checkbox"/> Thick Dark Surface (A12)	<input type="checkbox"/> Redox Dark Surface (F6)	
<input type="checkbox"/> Sandy Mucky Mineral (S1)	<input type="checkbox"/> Depleted Dark Surface (F7)	
<input type="checkbox"/> Sandy Gleyed Matrix (S4)	<input type="checkbox"/> Redox Depressions (F8)	

Indicators for Problematic Hydric Soils³:

³Indicators of hydrophytic vegetation and wetland hydrology must be present, unless disturbed or problematic.

Restrictive Layer (if present):

Type: _____

Depth (inches): _____

Hydric Soil Present? Yes _____ No

Remarks:

HYDROLOGY

Wetland Hydrology Indicators:

Primary Indicators (minimum of one required; check all that apply)		Secondary Indicators (2 or more required)
<input type="checkbox"/> Surface Water (A1)	<input type="checkbox"/> Water-Stained Leaves (B9) (except MLRA 1, 2, 4A, and 4B)	<input type="checkbox"/> Water-Stained Leaves (B9) (MLRA 1, 2, 4A, and 4B)
<input type="checkbox"/> High Water Table (A2)	<input type="checkbox"/> Salt Crust (B11)	<input type="checkbox"/> Drainage Patterns (B10)
<input type="checkbox"/> Saturation (A3)	<input type="checkbox"/> Aquatic Invertebrates (B13)	<input type="checkbox"/> Dry-Season Water Table (C2)
<input type="checkbox"/> Water Marks (B1)	<input type="checkbox"/> Hydrogen Sulfide Odor (C1)	<input type="checkbox"/> Saturation Visible on Aerial Imagery (C9)
<input type="checkbox"/> Sediment Deposits (B2)	<input type="checkbox"/> Oxidized Rhizospheres along Living Roots (C3)	<input type="checkbox"/> Geomorphic Position (D2)
<input type="checkbox"/> Drift Deposits (B3)	<input type="checkbox"/> Presence of Reduced Iron (C4)	<input type="checkbox"/> Shallow Aquitard (D3)
<input type="checkbox"/> Algal Mat or Crust (B4)	<input type="checkbox"/> Recent Iron Reduction in Tilled Soils (C6)	<input type="checkbox"/> FAC-Neutral Test (D5)
<input type="checkbox"/> Iron Deposits (B5)	<input type="checkbox"/> Stunted or Stressed Plants (D1) (LRR A)	<input type="checkbox"/> Raised Ant Mounds (D6) (LRR A)
<input type="checkbox"/> Surface Soil Cracks (B6)	<input type="checkbox"/> Other (Explain in Remarks)	<input type="checkbox"/> Frost-Heave Hummocks (D7)
<input type="checkbox"/> Inundation Visible on Aerial Imagery (B7)		
<input type="checkbox"/> Sparsely Vegetated Concave Surface (B8)		

Field Observations:

Surface Water Present?	Yes _____ No <input checked="" type="checkbox"/>	Depth (inches): _____	Wetland Hydrology Present? Yes _____ No <input checked="" type="checkbox"/>
Water Table Present?	Yes _____ No <input checked="" type="checkbox"/>	Depth (inches): _____	
Saturation Present? (includes capillary fringe)	Yes _____ No <input checked="" type="checkbox"/>	Depth (inches): _____	

Describe Recorded Data (stream gauge, monitoring well, aerial photos, previous inspections), if available:

Remarks:

Photographs

Photo Dates: January 29th, 2020



Photo looking west at Site 01. All ditch relief culverts have been recently installed during the fall of 2019 along with the grading, shaping, and rock surfacing of all permanently used roads. The ditch relief culverts were install correctly, only requiring the hand placement of additioan rock energy dissipaters at the outlets.



Photo looking northeast at Site 02. Additional competent rock surfacing is being prescribed here, and at other locations on the property where similar conditions exist. The majority of permanent roads on the property have adequate rock surfacing and a stable road surface. Certain locations require additional rock surfacing to create a stable road surface.



Photo looking southwest at Site 04. Note road rutting and rock surfacing. Additional competent rock surfacing (4" – 6" crushed angular) will be required here.



Photo looking at Site 05. A 15" diameter ditch relief culvert shall be installed here.



Photo looking down grade at Site 08. A ditch relief culvert will be installed here to drain the long, undrained, inside ditch that is discharging into a wetland area and the head of a Class III watercourse crossing. Note road rock surfacing and the stable road base. The majority of roads on the property are in similar condition.



Photo looking downgrade at Site 10. Note road rutting and rock surfacing. Additional competent rock surfacing (4" – 6" crushed angular) will be required here.



Photo looking south at Site 12 taken from Site 11.



Photo looking north at Site 11, taken from Site 12. The culvert proposed to be installed here will outlet into the ditch shown in the photograph. This culvert installation is being requested by CDFW and North Coast Regional Water Quality Board personel, to "re-align" a upland swale and wetland area that is being drained by an inside ditch along the left side of the road.



Photo looking southeast at the rocky ford watercourse crossing at Site 12. An 18" D x 20' culvert is being proposed as an upgrade to this crossing, per request by CDFW and North Coast Regional Water Quality Board personnel.



Photo looking south at the Past Cultivation Area and the rain catchment pond.



Photo looking southwest at the rain-catchment pond.



Photo looking at the southeastern side of the pond embankment with the bladder at Site 14 to the left and the pond overflow culvert to the right.



Photo looking southeast the the southern pond embankment.



Photo looking at the outlet of the pond overflow.



Photo looking at the Past Cultivation Area and Site 16.



Photo looking down grade at Site 18. Note road rock surfacing and the stable road base. The majority of roads on the property are in similar condition.



Photo looking at the inlet of the watercourse crossing at Site 21. Photo date 6-11-2016



Photo looking at the outlet of the watercourse crossing at Site 21. Photo date 6-11-2016



Photo looking at the inlet of the watercourser crossing at Site 22. Photo date 6-11-2016



Photo looking at the outlet of the watercourser crossing at Site 22. Photo date 6-11-2016

Site Management Plan

Mayers Flat Farm LLC

Location: 13360 Dyerville Loop Rd. Meyers Flat CA 95554

County: Humboldt

APN: 211-372-006

Address: P.O. Box 2114 Redway, CA 95560

Contact Name: Vanessa Valare

Telephone: 707.923.1180/760.613.6520

Email: etahumboldt@gmail.com

By: ETA Humboldt

Prepared by Marisa Cory

General Site Information

Discharger: Mayers Flat Farms, LLC

Landowner: Mayers Flat farms INC

GPS: 40.2626, -123.7370

Location: 13360 Dyerville Loop Rd. Myers Flat, CA 95554

Parcel Number: 211-372-006

Parcel Size: 80 acres

Disturbed Area: 43,000 sq. ft.

Cultivation Area and Type: 41,300 sq. feet mixed light

Tier Level:1

Risk Level: Low

1. Site Characteristics

1.1 General

This property is 80 acres of evergreen forest, mixed forest and grassland. Total disturbed area is approx. 43,000 square feet. Total cultivation area is 41,300 Square feet.

The applicant is dedicated to minimizing any negative impact to the rural community and natural environment surrounding this parcel. This would include eliminating light pollution, noise pollution, or any other adverse effect to neighbors. The applicant adheres to BMP in protecting the environment and works closely with county and state agencies to keep in compliance and run a safe clean farm. The applicant functions with great regard for the ecosystem in which it operates.

- A. The applicant's plans are to use the natural prime ag soils and only organic amendments to fortify the soil as needed.
- B. Soil samples will be taken and analyzed to ensure proper balance of nutrients are being used.
- C. Branches harvested during fuel reduction are composted and eventually used in swales, pathways, and remediation buffers to prevent nutrient runoff, reduce soil temperature, store carbon, and promote a healthy soil microbial community;
- D. Soil fertility is closely monitored to prevent excess use of fertilizers;
- E. Only organic products are used in the cultivation of cannabis;
- F. Cultivated soils are cover cropped and mulched in the off season to enhance soil fertility and eliminate runoff; and
- G. The entire site is monitored to identify and correct any potential sources of environmental degradation and maintain a protective riparian buffer

1.2 Structures on Site

Structures on the property relevant to the cultivation process include:

Greenhouse 1- 4,550 ft² of Outdoor Light Deprivation Cultivation.

Greenhouse 2- 4,200 ft² of Outdoor Light Deprivation Cultivation.

Greenhouse 3- 4,550 ft² of Outdoor Light Deprivation Cultivation.

Greenhouse 4- 3,500 ft² of Outdoor Light Deprivation Cultivation.

Greenhouse 5- 3,500 ft² of Outdoor Light Deprivation Cultivation.

Greenhouse 6- 3,500 ft² of Outdoor Light Deprivation Cultivation.

Greenhouse 7- 3,500 ft² of Outdoor Light Deprivation Cultivation.

Greenhouse 8- 3,500 ft² of Outdoor Light Deprivation Cultivation.

Greenhouse 9- 3,500 ft² of Outdoor Light Deprivation Cultivation.

Greenhouse 10- 3,500 ft² of Outdoor Light Deprivation Cultivation.

Greenhouse 11- 3,500 ft² of Outdoor Light Deprivation Cultivation.

Propagation Greenhouse- 3,900 ft² of greenhouse space for the propagation of immature plants

Pond- 350,000 gallons approx.

Well- 220' deep and 20 GPM

Water Tanks- 3 qty. 3,000-Gallon HDPE Water Storage Tank (existing)

Water Tanks- 1 qty. 1,100-Gallon HDPE Water Storage Tank (existing)

Water Tanks- 4 qty. 3,000-gallon HDPE water Storage Tanks (proposed)

Fertilizer Mixing Tank- 1 qty. 550-gallon HDPE Tank.

Processing Building 2,100 ft² Storage/Drying Processing Building with Nutrient storage room.

2 qty- 8' x 16' Connex Storage containers for secured Harvest storage

1.3 Access Roads

The site is located on Dyerville Loop Road, off Avenue of the Giants (Highway 254). in the Myers Flat Area. Personal driveway is shared with no additional neighbors. To access property from Eureka CA, via Highway 101;

Take Highway 101 south for 49.7 miles to the Myers Flat exit. (exit 656). Turn left onto the Avenue of the Giants (Highway 254 S) (1.9 mi.) Turn left onto Elk Creek Rd. (2.7 mi.) slight right

to stay on Elk Creek Rd. (207 ft) continue Straight onto Dyerville Loop Rd. (3.1mi.) Driveway is on the right.

1.4 Stream Crossings

There is one class II Tributary (Elk Creek) on the property. There are 2 (two) ditch relief culverts crossing cultivation area access roads. Culverts are in good condition, appear to be adequately sized and are functioning correctly. There are also 2 (two) ditch relief culverts on an unused access road that landowner has no easement to.

1.5 Electricity

Power for this parcel is provided by Solar. Generator on site for back up emergency power use only and will not be used more than 20% of the time.

1.6 Species of Concern

Species that have been recorded within the quadrat this site is located in include:

American Badger

American Peregrine Falcon

California Giant Salamander

Clear Lake - Russian River Roach

Navarro Roach

North American Porcupine

Pacific Lamprey

Pomo Bronze Shoulderband

Russian River Tule Perch

Sonoma Tree Vole

Townsend's Big-Eared Bat

Chinook Salmon - California Coastal ESU

Coho Salmon - Central California Coast ESU

Fisher - West Coast DPS

Foothill Yellow-Legged Frog

Great Blue Heron

Hoary Bat

Northern Goshawk

Northern Red-Legged Frog

Northern Spotted Owl

Oak Titmouse

Osprey

Pallid bat

Red-Bellied Newt

Short-Eared Owl

Silver-Haired Bat

Steelhead - Central California Coast DPS

Western Mastiff Bat

Western Pearlshell

Western Pond Turtle

Western Red Bat

White-Tailed Kite

Yellow Warbler

Yellow-Breasted Chat

2. Cultivation Plan

2.1 Grow Areas

Areas designated for cultivation on site include: three (3) cultivation areas. Cultivation Area 1 contains three (3) outdoor light deprivation greenhouses, two (2) at 4,550ft² each, and one (1) at 4,200 ft for a total of 13,300 ft². Cultivation area 2 contains four (4) outdoor light deprivation greenhouses; 3,500 ft² each for a total of 14,000 ft². Cultivation area 3 contains four (4) outdoor light deprivation greenhouses; 3,500 ft² each for a total of 14,000 ft² in which mature plants grow. Propagation area contains one (1) 3,900 ft² propagation greenhouse, used for the propagation of immature plants. One (1) 2,100 ft² processing building used for drying, curing, processing, and nutrient storage, two (2) Connex containers (8'x16') used for Secured Harbest Storage. One (1) generator shed used to house generator and associated fuel. Total cultivation area is 41,300 ft² square feet.

2.2 Harvesting

Cannabis will be harvested using gloves and clean tools. All cannabis will be hung to dry on-site in the processing building. A dehumidifier and fans as well as will be added to the processing building. Cannabis will be dried for 10-21 days on lines in this area depending on weather. The room will have proper ventilation, fans, and dehumidifiers to maintain proper environment. Moldy cannabis will be removed and destroyed using county and state approved procedures for holding and destroying unwanted product.

Cannabis trimming will occur as cannabis becomes ready from curing process. Trimming will physically take place in the processing building with plenty of ventilation and fresh air or outside when weather permits. The applicant plans to trim the cannabis them self by hand with the aid of a trim machine. If needed they will hire independent contractors with processor's licenses to help. Processed cannabis will be bagged into turkey bags or sealed bags to be held until a distributor is ready. The trim or remaining leaves from processed cannabis, will be bagged into brown lawn bags and into contractor bags to be stored until needed, sold or destroyed in the legal manner.

2.2.1 Independent Contract Workers

The applicant intends to do all the work themselves, however if the need arises for help independent contractors will be hired to help in their respective fields. Independent contractors

will have access to parking, spacious work zone, clean supplies for task, hand washing areas with soap, and a portable toilet. All areas will be kept clean and in good condition. All independent contractors will have access to personal safety equipment to meet the needs of the job for example, face mask, gloves, Tyvek suits, safety glasses, rubber boot covers etc. For the purpose of this document the term “employee” will refer to all people working on site. Additionally, the following practices will be implemented and only employ persons for hire as allowable by law. At all times workers shall have access to safe drinking water, toilets and handwashing facilities. Applicant has created a Worker Safety Practices outline as follows:

Safety protocols will be implemented to protect the health and safety of employees. All employees shall be provided with adequate safety training relevant to their specific job functions, which may include:

- 1) Employee accident reporting
- 2) Security breach
- 3) Fire prevention
- 4) Materials handling policies
- 5) Use of protective clothing such as long sleeve shirts, brimmed hats, and sunglasses.

Each garden site and or processing area have the following emergency equipment:

- 1) Personal protective equipment including gloves and respiratory protection are provided where necessary
- 2) Fire extinguisher
- 3) First Aid Kit
- 4) Snake Bite/Bee Sting Kit
- 5) Eye Washing Kit

Comply with all applicable federal, state, and local laws and regulations governing California Agricultural Employers, which may include: federal and state wage and hour laws, CAL/OSHA, OSHA, California Agricultural Labor Relations Act, and the Humboldt County Code (including the Building Code).

2.3 Monthly Cultivation Site Activities

Table 1: Monthly Cultivation Site Activities

Month	Activities
January	Finish processing of fall harvest, trimming and storage. Plan new year. Mow cover crop. Check greenhouse for issues/fix. Check water lines, tanks and all equipment for repairs or damages. Make plan for repairs.
February	Work on trenches/and holes for plants and layer more compost in beds. Treat compost if necessary. Finishing processing last year's crop if necessary.
March	Get clones from other permitted grow operation. Transplant and move into propagation greenhouse with seedlings. Amend beds, fix fences, service equipment, make plan for independent contractors such as painting, fence building, greenhouse fixing, etc.
April	Amend and start turning beds, prepare soil and supplies for greenhouse plants Add nematodes compost for pest prevention. Mid- April move first round of plants to greenhouses. Weed whacking, mowing, and brush cleanup.
May	Plant cannabis plants in main garden. Spray with preventive sulfur. Treat with biodynamic preparations for pest control and mold control. Greenhouse plants switched into flower using a blackout cover mid-late May. Turn beds, fix/ replace and clean drip emitters, check timers. Double check all water systems for leaks and clogs. Put out sound sensors for rodents.
June	Hay put over each trench for water retention and erosion prevention. Regular feeding schedule of compost teas adhered to. Pests are dealt with as they arise with oils, nematodes, and predator mites from compost. Procure next round of plants from licensed nursery.
July	Harvest greenhouse, replant with new clones from a permitted nursery. Treat plants with preventive measures. Harvested flowers to hang in garage, then to be cured and hand trimmed per processing plan.
August	Finish processing July's harvest. Monitor water supply, check lines and all areas for insect/ animal disturbance.
September	Prepare for Harvest. Clean and prepare lines and drying spaces in garage. Clean all supplies and purchase new items needed. Harvest, cure, and trim cannabis.

October	Harvest greenhouses and process as outlined above. Pull all root-balls, pack hay and cover crop seeds on beds. Pull drip system. Check all equipment and tools for leaks and damages before storing for winter. Store all supplies possible, cleanup site.
November	Winterize water system, greenhouse, and sheds. Clean up drying rooms remove all lines and debris. Put away all supplies i.e., fans, dehumidifiers. Continue processing cannabis as outlined above.
December	Start amendments for winter. Prep all water and water storage system for shut down. Clean all garden implements. Put all left over supplies away. Driveway fixing, other farm/garden maintenance.

3. Water

3.1 Source and System

Projected Water use for this site is approximately 397,693.75-gallons. The projected water use for the cannabis is approx. 379,443.75-gallons. Domestic water use is expected to be approx. 18,250-gallons. This water use is an estimate to the best of my knowledge. Domestic water is sourced from Domestic Use Spring S028042. The applicant also has a Small Irrigation Use Right H508360/H505233 to use water for irrigation if need be. The irrigation water source for this operation is rainwater stored in a pond that has a capacity of approximately 350,000-gallons. There is also a Well for use during periods of low rainfall or lack of rainwater. The rainwater stored in the pond will not provide enough water for all seasonal irrigation uses, so the applicant will also utilize a well on the property, which is 220' deep and yields 20GPM, for secondary water when the pond recedes.

3.2 Storage

There are 3 (three) 3,000-gallon HDPE water storage tanks and one 1,100-gallon HDPE water storage tank that are used to store the water from the pond for short periods of time. (less than 30 days). Applicant proposes to add another 4 (four) 3,000-gallon HDPE water storage tanks to the project.

3.3 Use

The water is used for on site irrigation and foliar spraying. The irrigation systems employed include drip irrigation and hand watering. Domestic water is used for the residence.

3.4 Conservation Methods Employed

Water use is monitored. Rice hay is utilized on surface of garden beds to reduce evaporative water loss.

3.5 System Maintenance

Entire water system including manifolds and fittings are inspected weekly for leaks, and drip system is inspected daily for leaks and damage.

4. Erosion and Sedimentation

4.1 Points of Concern

No notable erosion of road surface was observed anywhere on the property. No additional road surface drainage features are being proposed. No erosion of the cultivation area has been observed. No unstable areas on the property were observed.

4.2 Soil Management

The soil used onsite consists of a premixed soil blend in combination with coco coir. Soil deficiencies are determined by testing the soil, observation of the crop health and comparison of crop yields. Soils on site are reused and amended, rather than disposed of. This site has no problems with soil erosion.

4.3. Maintenance

Some of the soil conservation measures employed include the use of firebreaks, the encouragement of winter cover crops and general maintenance of the wildlife habitat.

5. Fertilizers, Herbicides and Pest Management

The applicant will follow best organic operation practices. Fertilizers, amendments or other agro-chemicals will be stored in dedicated locations within the first-floor garage of the residence. All fertilizers or other regulated and non-regulated agro-chemicals shall be stored within covered areas with secondary containment.

5.1 Herbicides/Weed Control

Biological, physical and cultural methods of weed control are employed. Hand-pulling weeds and weed eating are the primary methods used onsite for weed reduction.

5.1.2 Storage

Herbicides and fertilizers present on site will be stored in an insulated garage or shed with a locked door

5.2 Pest Management

This Pest Management Plan was prepared to be in compliance with California Department of Food and Agriculture requirements for CalCannabis cultivation licensing. This plan describes various pest

management options that the applicant will employ depending on conditions and circumstances. All pesticides and practices used will comply with California Department of Pesticide Regulation and the Humboldt County Agricultural Commissioner’s enforcement the use and sale of pesticides under Divisions 6 and 7 of the California Food and Agricultural Code, and Title 3 of the California Code of Regulations.

The applicant will be utilizing proper crop spacing, using proper nutrient levels and pH balance to minimize the spread of insects. The applicant will choose plant strains with genetics that have resistance to pest. Timing crop planting will also be utilized.

If deemed beneficial, the applicant will utilize lady bugs to control mite infestations, or any other predator insect that is approved for use.

The applicant will be utilizing chemicals as a preventative. The chemicals will be applied as a foliar spray. All products are OMRI listed and are organic.

Product Name	Active Ingredients
Neem Oil	Azadirachtin
Micro-ionized Sulfur	Sulfur
Green Cleaner	Soybean Oil, Sodium Lauryl Sulfate, Citric Acid, Isopropanol Alcohol

5.2.2 Storage

All chemicals shall be stored and handled according to the manufacturers recommendation and as outlined by the CDFA or any other best practices as outlined by a cannabis licensing bureau.

Pesticides, fungicides and other biocides on site will be stored in a shed with a raised floor with a locked door.

6. Petroleum, Gas and Oil

6.1 Use

Petrol products will be used in a generator on site to power artificial lighting, fans, dehumidifiers and other electric devices associated with the cultivation process.

6.2 Storage

The petroleum products will be stored in approved containers in a covered shed with containment devices in place.

7. Waste

7.1.1 Cultivation Waste

CERCC (Clean Energy Resource Conservation Commission) requires that the project be in compliance with the California Integrated Waste Management Act (CIWMA). In addition to cannabis waste, which is regulated by CERCC, the CIWMA requires that the project manage recycling of commercial solid waste and organic waste. The following project policies are regulated by local and state requirements:

- A. All cannabis waste shall be stored in a secure waste receptacle, or secured area, and disposed of in accordance with local and state regulations. “Secure waste receptacle” or “secured area” means that physical access to the receptacle or area is restricted to the licensee and its employees, or the local agency, or waste hauler franchised or contracted by a local agency.
- B. Public access to the designated cannabis waste receptacle or area shall be strictly prohibited.
- C. All commercial solid waste shall be stored separately from cannabis waste in disposal bins secure from wildlife and watershed discharge, divided out from trash and recyclables, and disposed in accordance local and state regulations.
- D. All hazardous waste regulated by the Integrated Pest Management Plan shall be dispose of properly utilizing protocols within that plan in compliance with all local and state regulations.

7.1.2 Tracking, Records, and Inspections

CERCC requires that the project be in compliance with the Track-and-Trace System and local requirements. The following policies shall be implemented to ensure compliance with the local and state requirements:

A. In addition to all other tracking requirements, disposal of cannabis waste shall use the Track-and-Trace System with documentation to ensure cannabis waste is identified, weighed, and tracked while on premises and when disposed.

B. All cannabis plant material identified as cannabis waste shall be reported in the Track-and-Trace System made within three (3) business days of the change in disposition from cannabis plant material into cannabis waste scheduled for destruction or disposal.

C. Review of on-site cannabis, Track-and-Trace System records, cannabis waste, commercial waste, and any other records shall be available for CDFA (California Dept of Food and Agriculture) inspection or their designated representative. Inspections shall occur at standard business hours from 8:00am to 5:00pm. Prior notice for inspections is not required by the inspecting agency.

D. No person shall interfere with, obstruct or impede inspection, investigation or audit. This includes, but is not limited to, the following actions: Denying the department access to the licensed premises. Providing false or misleading statements. Providing false, falsified, fraudulent or misleading documents and records, and failing to provide records, reports, and other supporting documents.

E. Accurate and comprehensive records shall be maintained on-site for seven (7) years regarding cannabis waste which are subject to CDFA inspection that account for, reconcile, and evidence all activity related to the generation or disposition of cannabis waste.

7.1.3 Internal Waste Management Policies

The following waste management policies shall be implemented to ensure compliance with the local and state regulations, as well as CIWMA, CERCC and, CWMP (Cannabis Waste Management Plan):

A. The CWMP shall be retained on-site at all times. B. Each new laborer that comes onto the site shall be provided with a copy of the CWMP and it shall be their responsibility to read the CWMP.

- C. The operator shall instruct all laborers as to the location and proper disposal of cannabis waste.
- D. The operator shall monitor the process of waste management and reuse of cannabis waste to ensure compliance with the CWMP, local requirements, Integrated Waste Management Act, and CERCC.
- E. The operator shall ensure that all supporting documentation which demonstrates compliance with the CWMP is provided to the local or state enforcement agency upon request or when required.
- F. Waste reduction and recycling strategies shall be periodically reviewed.
- G. Every effort shall be made to use to reduce the amount of cannabis waste sent to landfills by on-site composting and reuse.
- H. Any person hauling away cannabis waste shall notify the operator of the materials, location of disposal, and provide written record.
- I. The waste hauler shall track the total amount of cannabis waste leaving the project by weight or by volume and supply the operator with copies of tickets or detailed receipts from all loads of cannabis waste removed from the site

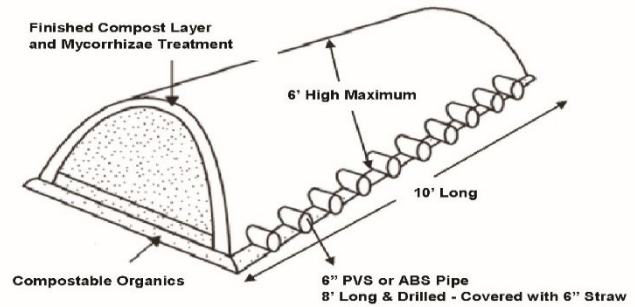
7.1.4 On Site Cultivation Waste Disposal

The CWMP identifies one or more of the following approved methods for cannabis waste and organic waste according to the CIWMA, CERCC and, CWMP:

On-premises disposal of cannabis and organic waste: Composting cannabis waste shall be in compliance with title 14 of the California Code of Regulations Division 7 Chapter 3.1 (commencing with Section 17850) by one or more of the following methods:

Passive Aerated Static Pile: a composting process that is similar to the aerated static pile except that the air source may or may not be controlled.

Land Application: final deposition of compostable material shall be spread on-site land (i.e. compost used within gardens).



7.2 Trash

Rubbish is stored in a secure area in the garage and is removed on a monthly basis. Solid waste is hauled to an approved county location.

The CWMP identifies one or more of the following methods for managing solid waste and recyclables according to the CIWMA, CERCC and, CWMP:

self-haul refuse and recycling to approved county location;

Redway Transfer Station

Conservation Camp Rd.

Redway, CA 95560

7.3 Domestic Wastewater

An existing septic system is utilized in handling domestic wastewater. Primary and secondary leach fields have been identified. System is in good functioning condition. At the cultivation area an ADA portable toilet with a service contract is utilized.

7.4 Hazardous Waste

Gasoline and propane are stored on site for heating and power supply. All fuels are stored in approved storage containers. Diesel and gasoline are stored in covered area with containment device. All fertilizers, soil amendments, and pesticides used on site are stored indoors in approved containers. Bleach and alcohol are used on site to clean small hand tools typically these products would be stored in office areas in one-gallon bottles or smaller. Other household sanitizers may be used in kitchen and bathrooms. Small equipment and generator oil may be changed on site if said procedure will be completed over containment devices to prevent spillage

8. Appendix

8.1 Best Practical Treatment or Control Measures

Other measures to be implemented

Description BMP procedure

- List of record keeping, monitoring, and other measures needed for compliance.
- Install flow meters for Install flow meters water use and record water use weekly.
- Use log pages and provide additional documentation as needed.
- Record water use.
- Read flow meters weekly and record irrigation use by water source.
- Use log pages provide additional documentation as needed.
- Wet weather road inspection.
- Inspect road during wet weather annually.
- Observe water and sediment discharge.
- Document observations, apply corrective measures to prevent erosion as needed based on observations.
- Pre and post season inspection, conduct self- assessment twice annually.
- Use log pages provide additional documentation as needed.
- Keep chemical storage and use logs
- List chemicals stored onsite and information about quantities used and frequency applied.
- Record annual fertilizer and amendment use.

8.2 Example Logbook

Post-Season Self-Assessment (to be completed by October 15th each year)

Person Reporting: _____

Date: _____

Yes N/A

All stockpiles, soil amendments, pesticides, and fertilizers have been properly stored and/or protected per Best Management Practices (BMPs).

Comments

Yes N/A

Erosion and sediment controls have been properly installed and are functioning, and all areas of exposed soil have been stabilized in preparation for the winter wet weather period. Comments

Yes N/A

Drainage structures (waterbars/rolling dips) have been installed and are functioning on all access roads, and all access roads intended for use during the winter wet weather period have been weatherproofed. Comments

Yes N/A

Watercourse crossing structures have been correctly installed/maintained, all fill material/exposed soil has been stabilized, and are free of debris that could plug crossings over the winter wet weather period. Comments

Yes N/A

All trash/refuse has been cleaned up where it cannot pass into or be transported into any water body and empty/used containers have been properly disposed per manufacturer's instructions. Comments

Yes N/A

All water containment/storage ponds/dams have been inspected and appear to be in good, stable condition.

Additional Findings/Comments:

8.3 Emergency Contact Information

Mayers Flat Farms shall visibly post and maintain an emergency contacts list which will include at a minimum:

1. Managerial and property owner contact(s):

Property Owner/Manager: Mayers Flat Farms **305-490-8821**

1. Emergency responder contact(s):

- a. EMERGENCY CALL 911

Site Address: 13360 Dyerville Loop Rd. Myers Flat, CA 95554

- b. Nonemergency Sheriff: (707) 445-7251

2. Hazardous Material/Poison control contact(s):

- a. EMERGENCY CALL 911

Site Address: 13360 Dyerville Loop Rd. Myers Flat, CA 95554

- b. Poison Control Centers 1-800-222-1222

- c. Humboldt County HazMat: (707)268-8680

- d. Humboldt County Ag Dept: (707)234-6830