

## AGREEMENT

This is an AGREEMENT made and entered into this 23 day  
of June, 2021, by and between the County of Humboldt, a  
political subdivision of the State of California (hereinafter referred to as COUNTY)  
and Granite Construction Company,  
a corporation organized and existing under the laws of the State of California,  
hereinafter referred to as "CONTRACTOR".

### Section 1 - SCOPE OF WORK

Contractor shall furnish all Labor, Tools and Materials and perform all the work for the:

**STORM DAMAGE REPAIRS TO ALDERPOINT ROAD  
(F6B165)  
AT PM 21.8, 22.8, 23.0-23.05 & 23.75  
ER-32L0(329) & ER-32L0(300)  
CONTRACT NO.: 217288 & 217294**

in accordance with the contract documents referred to in Section 3 of this Agreement.

### Section 2 - CONTRACT PRICE

County shall pay, and Contractor shall accept Contractor's Bid Prices, as shown on EXHIBIT "A" attached hereto and made a part hereof, as full compensation for furnishing all materials and for doing all the work contemplated and embraced in this Agreement; also for all loss or damage, arising out of the work aforesaid, or from the actions of the elements, or from any unforeseen difficulties or obstructions which may arise or be encountered in the prosecution of the work until its acceptance by County, and for all risks of every description connected with the work; also for all expenses incurred by or in consequence of the suspension or discontinuance of the work and for well and faithfully completing the work, and the whole thereof, in the manner and according to the Plans and Specifications, and the requirements of the Engineer.

### **Section 3 - CONTRACT DOCUMENTS**

The complete contract between the parties hereto shall consist of the following, hereinafter referred to as the CONTRACT DOCUMENTS:

- Notice to Bidders
- Plans and Drawings
- Bid Form
- Bidder's Bond
- Supplemental Project Information
- Performance Bond
- Payment Bond
- This Agreement
- Special Provisions

And, as published by the Department of Transportation, State of California, except as modified by the Special Provisions:

- Standard Plans - dated 2018
- Revised Standard Plans – dated 04-17-2020
- Standard Specifications - dated 2018
- Revised Standard Specifications Dated 04-17-2020
- Equipment Rental Rates in effect at the time the work is performed

And, as published by the California Department of Industrial Relations, and the California Business, Transportation and Housing Agency:

- General Prevailing Wage Rates
- Labor and Surcharge Rates

And any addenda to any of the above documents, all of which are on file in the office of the Director of Public Works of the County of Humboldt. Each of said CONTRACT DOCUMENTS is incorporated and made a part of this Agreement by the reference contained in this Section.

All rights and obligations of the County and the Contractor are fully set forth and described in the Contract Documents. All of the above named documents are intended to be complimentary, so that any work called for in one, and mentioned in the other is to be performed and executed the same as if mentioned in all said documents.

### **Section 4 - BEGINNING OF WORK**

Following receipt and full execution and approval of the Contract Documents, and posting of the requisite Bonds as called for therein, the COUNTY will issue a "Notice to Proceed". Under no circumstances shall the CONTRACTOR enter upon the site of work until receipt of the "Notice to Proceed", or unless so authorized in writing by the COUNTY.

**Section 5 - TIME OF COMPLETION**

The work called for in this Agreement shall be commenced within fifty-five (55) days of receipt of Notice to Proceed by COUNTY and shall be fully completed within a period of 120 working days beginning on the fifty-fifth calendar day after the date of said approval of contract.

**Section 6 - PREVAILING WAGE**

Copies of the prevailing wage rates of per diem wages are on file in the Humboldt County Public Works office at 1106 Second Street, Eureka, California and are available to any interested person on request.

**Section 7 - WORKERS' COMPENSATION**

By my signature hereunder, as CONTRACTOR, I certify that I am aware of the provisions of Section 3700 of the Labor Code which requires every employer to be insured against liability for Workers' Compensation or to undertake self insurance in accordance with the provisions of that code, and I will comply with such provisions before commencing the performance of the work of this contract.

**Section 8 - COMPLIANCE WITH LAWS**

The Contractor agrees to comply with all local, state, and federal laws and regulations, including but not limited to the Americans With Disabilities Act. The Contractor further agrees to comply with any applicable federal, state or local licensing standards, any applicable accrediting standards, and any other applicable standards or criteria established locally or by the state or federal governments.

This agreement shall be governed by and construed in accordance with the laws of the State of California.

**Section 9 - NOTICES**

All notices shall be in writing and delivered in person or transmitted by mail. Notices required to be given to the COUNTY shall be addressed as follows:

Humboldt County Department of Public Works  
1106 Second Street, Eureka, California, 95501

✓ Notices required to be given to CONTRACTOR shall be addressed as follows:

Granite Construction Company  
Attn: Steve Espinoza, Project Manager  
1324 S. State Street  
Ukiah, CA 95482

IN WITNESS WHEREOF, The parties hereto have entered into this Agreement as of the date first above set forth.

COUNTY OF HUMBOLDT

BY *Vernice Bass*

(SEAL)

Chair, Board of Supervisors  
of the County of Humboldt,  
State of California

ATTEST:

KATHY HAYES

Clerk of the Board of Supervisors  
of the County of Humboldt,  
State of California

BY *Kathy Hayes*

Clerk of the Board

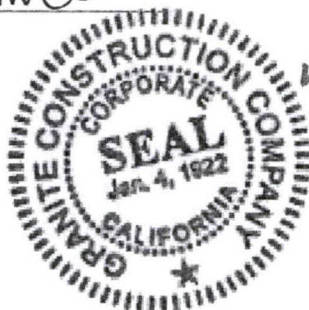

GRANITE CONSTRUCTION COMPANY

BY *Kenneth B. Olson*

TITLE Kenneth B. Olson, Vice President

BY See Attached Certificate of Secretary

TITLE \_\_\_\_\_

(Two Signatures Required For Corporation)

APPROVED AS TO FORM:

BY NA  
Deputy County Counsel

INSURANCE CERTIFICATES REVIEWED  
AND APPROVED:

BY *Kauffman*  
Risk Manager



## GRANITE CONSTRUCTION COMPANY

### CERTIFICATE OF SECRETARY

I, M. Craig Hall, Secretary of GRANITE CONSTRUCTION COMPANY, a California corporation (the "Company"), do hereby certify that the following is a true and correct copy of resolutions duly adopted effective January 26, 2021 by a Unanimous Written Consent of the Board of Directors in accordance with the provisions of Article III, Section 9 of the Bylaws of the Company; that the Directors acting were duly and regularly elected; and that the resolutions adopted have not been repealed and are still in full force and effect:

#### AUTHORIZATION TO EXECUTE DOCUMENTS AND AGREEMENTS

**RESOLVED**, that the below listed officers are authorized to execute and deliver on behalf of the Company all documents, agreements and undertakings required in connection with construction contract formation and operations of the Company:

Kyle T. Larkin	President
Elizabeth L. Curtis	Executive Vice President, Chief Financial Officer & Assistant Secretary
Jigisha Desai	Executive Vice President, Chief Strategy Officer & Assistant Secretary
James A. Radich	Executive Vice President, Chief Operating Officer & Assistant Secretary
Carlos F. Alegre	Senior Vice President of Operations Services & Assistant Secretary
Brian R. Dowd	Senior Vice President, Group Manager & Assistant Secretary
Timothy W. Gruber	Senior Vice President, Human Resources & Assistant Secretary
M. Craig Hall	Senior Vice President, General Counsel, Corporate Compliance Officer & Secretary
Richard M. Rantala	Senior Vice President, Business Development & Assistant Secretary
James D. Richards	Senior Vice President, Group Manager & Assistant Secretary
Michael G. Tatusko	Senior Vice President, Group Manager & Assistant Secretary
Mathew C. Tyler	Senior Vice President, Federal Group Operations & Assistant Secretary
Robert C. VanGorder	Senior Vice President, Group Manager & Assistant Secretary
Michael W. Barker	Vice President, Finance
James D. Nickerson	Vice President & Assistant Secretary
Kenneth B. Olson	Vice President, Treasurer, Assistant Financial Officer & Assistant Secretary
Nicholas B. Blackburn	Director of Corporate Taxation & Assistant Secretary

**RESOLVED FURTHER**, that the authority provided for herein shall be in accordance with applicable policies, procedures and limits of authority previously approved and the Granite Construction Incorporated Delegation of Authority and Policy then in effect.

**AUTHORIZATION TO ATTEST DOCUMENTS AND AGREEMENTS**

**RESOLVED**, that the below listed officers are authorized to attest documents, agreements and undertakings required in connection with construction contract formation and operations of the Company:

Kyle T. Larkin	President
Elizabeth L. Curtis	Executive Vice President, Chief Financial Officer & Assistant Secretary
Jigisha Desai	Executive Vice President, Chief Strategy Officer & Assistant Secretary
James A. Radich	Executive Vice President, Chief Operating Officer & Assistant Secretary
Carlos F. Alegre	Senior Vice President of Operations Services & Assistant Secretary
Brian R. Dowd	Senior Vice President, Group Manager & Assistant Secretary
Timothy W. Gruber	Senior Vice President, Human Resources & Assistant Secretary
M. Craig Hall	Senior Vice President, General Counsel, Corporate Compliance Officer & Secretary
Richard M. Rantala	Senior Vice President, Business Development & Assistant Secretary
James D. Richards	Senior Vice President, Group Manager & Assistant Secretary
Michael G. Tatusko	Senior Vice President, Group Manager & Assistant Secretary
Mathew C. Tyler	Senior Vice President, Federal Group Operations & Assistant Secretary
Robert C. VanGorder	Senior Vice President, Group Manager & Assistant Secretary
Michael W. Barker	Vice President, Finance
James D. Nickerson	Vice President & Assistant Secretary
Kenneth B. Olson	Vice President, Treasurer, Assistant Financial Officer & Assistant Secretary
Nicholas B. Blackburn	Director of Corporate Taxation & Assistant Secretary
Jordy L. Murray	Deputy General Counsel & Assistant Secretary
Kenneth M. Smith	Group Counsel & Assistant Secretary
Jason M. Jasper	Group Counsel & Assistant Secretary
Eric J. Rietz	Group Counsel & Assistant Secretary

Dated: January 28, 2021

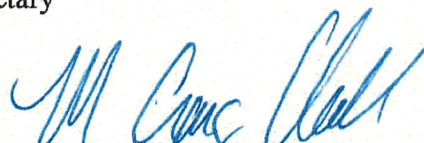
  
\_\_\_\_\_  
M. Craig Hall



Granite Construction Company **BID FORM (EXHIBIT A) PAGE 1 OF 2**

**STORM DAMAGE REPAIRS ON ALDERPOINT ROAD  
(F6B165) PM 21.8,22.8, 23.0-23.05 & 23.75  
PROJECT NO.: ER-32L0(329) & ER-32L0(300)  
CONTRACT NO.: 217288 & 217294**

ITEM NO.	ITEM CODE	ITEM DESCRIPTION	UNIT	QTY	UNIT PRICE	TOTAL
1	100100	DEVELOP WATER SUPPLY	LS	1	25,360.00	25,360.00
2	120090	CONSTRUCTION AREA SIGNS	EA	22	240.00	5,280.00
3	120100	TRAFFIC CONTROL SYSTEM	LS	1	175,250.00	175,250.00
4	120165	CHANNELIZER (SURFACE MOUNTED)	EA	216	45.00	9,720.00
5	129000	TEMPORARY RAILING (TYPE K)	LF	1,420	30.00	42,600.00
6	129110	TEMPORARY CRASH CUSHION	EA	10	1,025.00	10,250.00
7	130100	JOB SITE MANAGEMENT	LS	1	9,000.00	9,000.00
8	130300	PREPARE STORM WATER POLLUTION PREVENTION PLAN	LS	1	2,000.00	2,000.00
9	130310	RAIN EVENT ACTION PLAN	EA	20	500.00	10,000.00
10	130320	STORM WATER SAMPLING ANALYSIS DAY	DAY	6	250.00	1,500.00
11	130330	STORM WATER ANNUAL REPORT	EA	1	2,000.00	2,000.00
12	130610	TEMPORARY CHECK DAM	LF	360	11.00	3,960.00
13	130620	TEMPORARY DRAINAGE INLET PROTECTION	EA	5	62.00	310.00
14	130680	TEMPORARY SILT FENCE	LF	970	3.00	2,910.00
15	130710	TEMPORARY CONSTRUCTION ENTRANCE	EA	2	8,425.00	16,850.00
16	130900	TEMPORARY CONCRETE WASHOUT	EA	2	580.00	1,160.00
17	170103	CLEARING AND GRUBBING	LS	1	28,650.00	28,650.00
18	190101	ROADWAY EXCAVATION	CY	11,510	35.00	402,850.00
19	192049	[F] STRUCTURE EXCAVATION (SOLDIER PILE WALL)	CY	162	140.00	22,680.00
20	193029	[F] STRUCTURE BACKFILL (SOLDIER PILE WALL)	CY	37	500.00	18,500.00
21	193116	[F] CONCRETE BACKFILL (SOLDIER PILE WALL)	CY	40	290.00	11,600.00
22	193119	[F] LEAN CONCRETE BACKFILL	CY	28	220.00	6,160.00
23	198215	SUBGRADE ENHANCEMENT GEOGRID	SY	1,700	3.00	5,100.00
24	210280	ROLLED EROSION CONTROL BLANKET	SQFT	33,035	1.18	38,981.30
25	210420	STRAW	SF	2,580	0.07	180.60
26	210350	FIBER ROLLS	LF	2,630	7.68	20,198.40
27	260203	CLASS 2 AGGREGATE BASE	CY	744	140.00	104,160.00
28	390132	HOT MIX ASPHALT (TYPE A)	TON	805	235.00	189,175.00
29	394077	PLACE HOT MIX ASPHALT DIKE (TYPE F)	LF	215	42.00	9,030.00
30	398200	COLD PLANE ASPHALT CONCRETE PAVEMENT	SY	60	205.00	12,300.00
31	460210	[P] GROUND ANCHOR (SUBHORIZONTAL)	EA	15	7,740.00	116,850.00

Granite Construction Company  
**ADDENDUM No. 1**  
**BID FORM (EXHIBIT A) PAGE 2 OF 2**

32	4903XX	[P]	STEEL SOLDIER PILE (W 12 X 65)	LF	642	82.00	52,644.00
33	490400		24" DRILLED HOLE	LF	578	250.00	144,500.00
34	575004	[F]	TIMBER LAGGING	MFBM	14	6,970.00	97,580.00
35	590120		CLEAN AND PAINT STEEL SOLDIER PILING	LS	1	60,146.00	60,146.00
36	6411XX	[P]	8" PLASTIC PIPE	LF	14	135.00	1,890.00
37	665016		18" CORRUGATED STEEL PIPE (0.064" THICK)	LF	270	155.00	41,850.00
38	665022		24" CORRUGATED STEEL PIPE (0.064" THICK)	LF	133	145.00	19,285.00
39	665030		30" CORRUGATED STEEL PIPE (0.064" THICK)	LF	62	225.00	13,950.00
40	680254		CLEANOUT ASSEMBLY	EA	9	2,950.00	26,550.00
41	680902		6" PERFORATED PLASTIC PIPE UNDERDRAIN	LF	1,037	65.00	67,405.00
42	680905		8" PERFORATED PLASTIC PIPE UNDERDRAIN	LF	112	90.00	10,080.00
43	681990		FILTER FABRIC	SY	3,510	1.50	5,265.00
44	682020		CLASS 1 PERMEABLE MATERIAL	CY	2,095	85.00	178,075.00
45	690122		24" CORRUGATED STEEL PIPE DOWNDRAIN (0.064" THICK)	LF	8	265.00	2,120.00
46	692307		18" ANCHOR ASSEMBLY	EA	5	1,025.00	5,125.00
47	700637		36" CORRUGATED STEEL PIPE INLET	LF	39	905.00	35,295.00
48	710136		REMOVE PIPE	LF	187	35.00	6,545.00
49	723080		ROCK SLOPE PROTECTION (60 lb, Class II, METHOD B)	CY	25	375.00	9,375.00
50	729011		ROCK SLOPE PROTECTION FABRIC (CLASS 8)	SY	111	6.00	666.00
51	750001	[F]	MISCELLANEOUS IRON AND STEEL	LB	885	5.00	4,425.00
52	820130		OBJECT MARKER	EA	2	250.00	500.00
53	832007		MIDWEST GUARDRAIL SYSTEM (WOOD POST)	LF	113	88.00	9,944.00
54	832070		VEGETATION CONTROL (MINOR CONCRETE)	SY	111	55.00	6,165.00
55	839521	[F]	CABLE RAILING	LF	112	95.00	10,640.00
56	839584		ALTERNATIVE IN-LINE TERMINAL SYSTEM	EA	2	5,000.00	10,000.00
57	840560		THERMOPLASTIC TRAFFIC STRIPE (SPRAYABLE)	LF	1,160	3.50	4,060.00
58	210212		DRY SEED	SQFT	2,580	0.18	464.00
59	665045		48" CORRUGATED STEEL PIPE (0.064" THICK)	LF	60	550.00	33,000.00
60	999990		MOBILIZATION	LS	1	229,650.00	229,650.00

NOTE: ITEM CODE LETTER DESIGNATION; F= FINAL PAY QUANTITY, P=ITEM ELIGIBLE FOR PARTIAL PAY

**BID TOTAL**

\$2,391,699.70

-checked  
CKH  
5/4/2021

ACKNOWLEDGEMENT OF ADDENDA

<u>ADDENDUM NO.</u>	<u>INITIAL</u>
Addendum 1	SL
Addendum 2	SL
Addendum 3	SL

  
 (Bidder's Signature)

Justin Ingram, Area Manager

(Title)







**County of Humboldt**  
**Department of Public Works**  
**1106 Second Street**  
**Eureka, CA 95501**  
**TEL (707) 445-7652**

**ADDENDUM NO. 1**  
 (Issued April 6, 2021)

**STORM DAMAGE REPAIRS TO ALDERPOINT ROAD (F6B165)**  
**AT PM 21.8, 22.8, 23.0-23.05**  
**PROJECT NO.: ER-32L0(329)**  
**CONTRACT NO.: 217288**

The Special Provisions and Plans are hereby modified in accordance with the following:

1. The bid opening date is changed to May 4<sup>th</sup>, 2021 at 2:00pm.
2. The bid opening location is changed to the Humboldt County Public Works building on 1106 2<sup>nd</sup> Street, Eureka CA. Bids will be opened outside the building in the adjacent parking lot.

Options for delivering bid packages:

- Mail or use delivery service (FedEx or UPS) to send bid package to Public Works, 1106 2<sup>nd</sup> Street, Eureka, CA.
- Deposit bid package into mail slot in the front door of Public Works, 1106 2<sup>nd</sup> Street, Eureka, CA.
- Hand deliver to Engineering Staff between 1:45pm and 2:00pm at the opening site.

**PROJECT PLANS**

1. Sheet 1, Title Sheet, is revised to include the culvert replacement at Alderpoint Road PM 23.75, Project No. ER-32L0(300), Contract No. 217294.
2. Sheet Q-1, quantities updated.
3. Alderpoint Road PM 23.75 plan and profile sheet 46 of 46 is added to the planset.

**I M P O R T A N T**

**This Addendum is being sent EMAIL/FAX. To indicate receipt of this Addendum please sign and EMAIL/FAX this page back to the Department of Public Works at (707) 445-7409.**

Received by: \_\_\_\_\_ Date \_\_\_\_\_  
 Company: \_\_\_\_\_ # Pages Received \_\_\_\_\_

**Total Pages Sent 8**

**(Addendum No. 1)****PROJECT SPECIAL PROVISIONS**

1. Special Provisions pages 1, 2, 7, 10, 64, 70, 94, 98, 99 are revised to include the culvert replacement at Alderpoint Road PM 23.75, Project No. ER-32L0(300), Contract No. 217294.
2. Special Provisions pages 61-62, Bid Form (Exhibit A) shall be replaced by the attached Addendum No. 1 Bid Form (Exhibit A).
3. Special Provisions Section 8-1.04C, the following sentence shall be deleted:

“If the submittals for Contractor-supplied biologist and biological resource information program are authorized, you may enter the job site only to measure controlling field dimensions and locate utilities.”

**CONTRACTOR QUESTIONS**

1. On previous projects, there has been a bid item for temporary traffic signal. There is no item on this project. Are the temporary signals to be included in the traffic control system?

*Temporary traffic signals are included in the traffic control system item.*

2. Are cross-sections available for each location?

*Cross-sections will be available to the winning bidder.*

3. There is no dry seed item. Is dry seed to be included in another EC item?

*Dry seed item is not included in another EC item. Added as item #58.*

ITEM	UNIT	21.8	22.8	23.0	23.05	TOTAL
DRY SEED	LF	2185	395	0	0	2580

4. The 18” CSP quantities seem to miss DS-6 and the lower pipe in DS-7. Can you please verify the item quantity?

*Updated items 18" corrugated steel pipe and 24" corrugated steel pipe see below.*

ITEM	UNIT	21.8	22.8	23.0	23.05	TOTAL
18" CORRUGATED STEEL PIPE (0.064" THICK)	LF	42	0	106	122	270
24" CORRUGATED STEEL PIPE (0.064" THICK)		0	133	0	0	133

**(Addendum No. 1)**

5. The quantity sheet shows quantities for remove pipe at PMs 23.0 & 23.05 that aren't shown on the drainage plans. D-2 shows 3 pipes to be removed at PM 22.8 that appear longer than the 40 if shown for that location. Can you please verify the lengths of pipe to be removed at the locations?

*There is no pipe removal at PM 23.0 & 23.0, updated remove pipe item, see below.*

ITEM	UNIT	21.8	22.8	23.0	23.05	TOTAL
REMOVE PIPE	LF	38	149	0	0	187

6. The RSP quantities appear to neglect one of the two dissipators at DS-7.

*Updated rock slope protection (60lb, class II, method B), see below.*

ITEM	UNIT	21.8	22.8	23.0	23.05	TOTAL
ROCK SLOPE PROTECTION (60 lb, Class II, METHOD B)	CY	3	10	6	6	25

7. Is there a temporary construction easement (TCE) at Alderpoint Road PM 21.8?

*No, there is not a TCE; however, the County claims implied common law dedication to access the site for construction and maintenance of the wall. The implied common law dedication shown for the two permanent drain outlets also applies to the construction and maintenance of the wall. The grading needed in front of the wall to place the lagging, underdrain, and backfill is covered by an implied common law dedication. The implied common law dedication extends to the toe of the slope for construction and maintenance.*

**Approved:**



04/02/2021

Jason Hickey  
SE 5783

Date

ROAD NAME: ALDERPOINT ROAD	MILE POST: 21.8, 22.8, 23.0-23.05
ROAD NO.: F6B165	EA NO.:
PROJECT NO.: ER-32L0(329)	BRIDGE NO.: N/A
CONTRACT NO.: 217288	DRAWING FILE NAME:
PLOT DATE: APRIL 2021	REVISION DATE:

**MARK THOMAS**  
DESIGNED BY: CM  
DRAWN BY: CM  
REVIEWED BY: KD  
APPROVED BY:

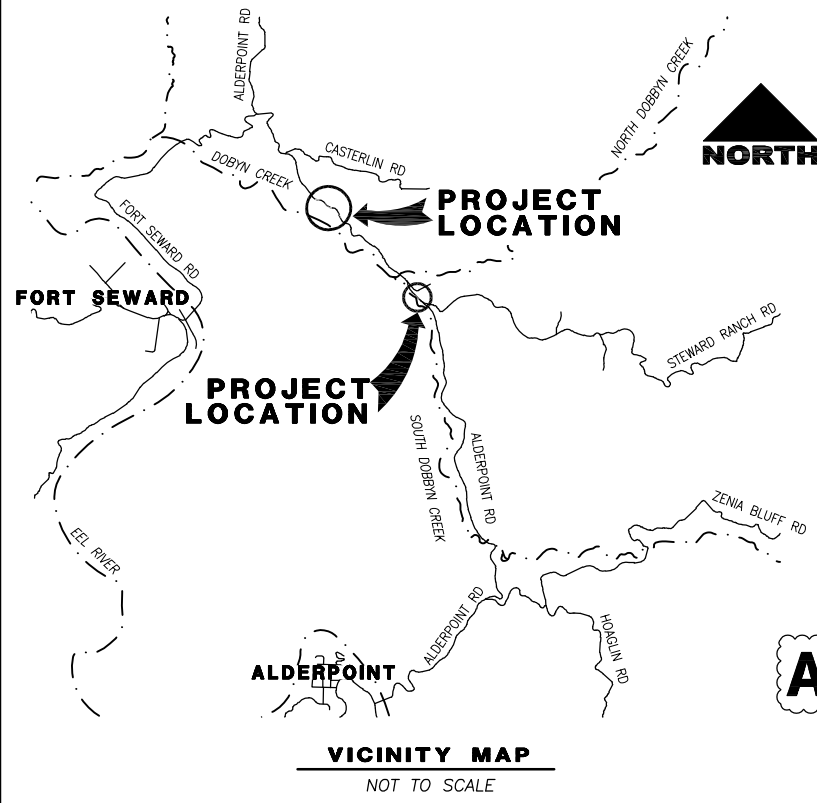

# COUNTY OF HUMBOLDT DEPARTMENT OF PUBLIC WORKS

## PROJECT PLANS FOR CONSTRUCTION OF STORM DAMAGE REPAIRS ON ALDERPOINT ROAD [F6B165] AT P.M. 21.8, 22.8, 23.0-23.05 PROJECT NO. ER-32L0(329) AND 23.75 PROJECT NO. ER-32L0(330) CONTRACT NO. 217288

TO BE SUPPLEMENTED BY STATE OF CALIFORNIA DEPARTMENT OF TRANSPORTATION  
STANDARD PLANS, STANDARD SPECIFICATIONS, AND LATEST REVISED 2018 STANDARD SPECIFICATIONS

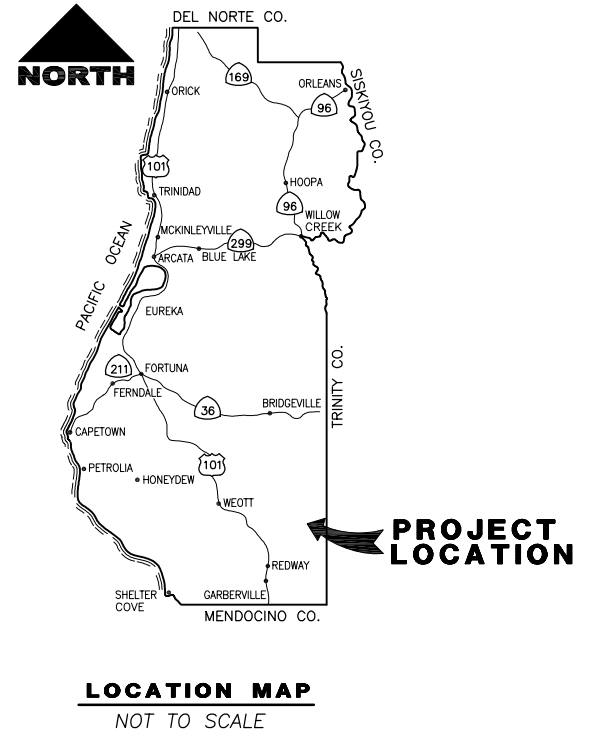

**INDEX OF SHEETS**

- 1 TITLE SHEET
- 2 BID QUANTITY SUMMARY
- 3 PROJECT CONTROL
- 5 TYPICAL CROSS SECTIONS
- 8 LAYOUT
- 13 PROFILE AND SUPERELEVATION
- 18 DRAINAGE AND UTILITIES
- 23 DRAINAGE DETAILS
- 25 EROSION CONTROL
- 30 STAGE CONSTRUCTION
- 37 SIGNING AND STRIPING
- 38-45 PLANS
- 46 CULVERT REPLACEMENT 1

**NOTES**

1. THE CONTRACTOR SHALL HAVE A CLASS "A" LICENSE FOR THIS PROJECT.
2. STANDARD PLAN LIST APPLICABLE TO THIS CONTRACT IS INCLUDED IN THE SPECIAL PROVISIONS.

**GEOTECHNICAL REPORT**

AUGUST 2020  
CRAWFORD & ASSOCIATES, INC.

**LEGEND:**

1 ADDENDUM #1

**PROPOSED LOCATION**  
(PM 23.75) 1

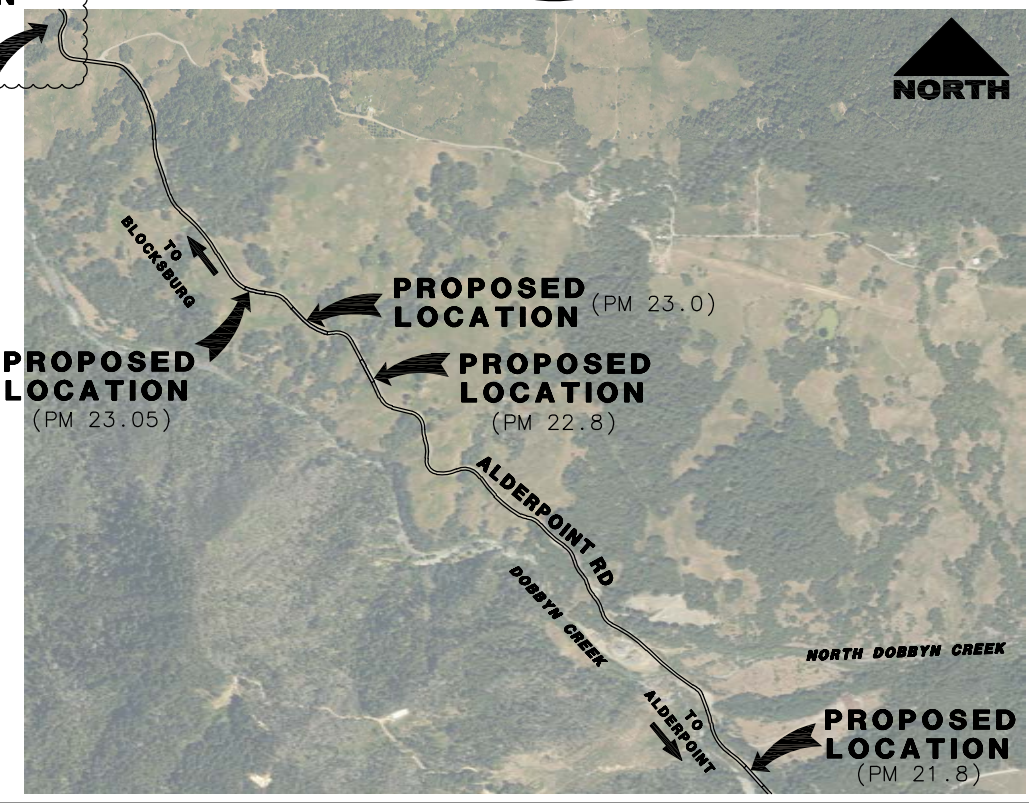

APPROVED BY: Tony Seghetti 04/06/2021  
TONY SEGHETTI, RCE | 63714 DATE  
COUNTY OF HUMBOLDT  
PUBLIC WORKS DEPUTY DIRECTOR



J. Hickey 03/09/21  
JASON HICKEY, SE 5783 DATE

ORIGINAL LOW BID PRICE	CONSTRUCTED BY	RESIDENT ENGINEER
	PROJECT COMPLETED	CONSTRUCTION COST \$



**LEGEND:**

1 ADDENDUM #1

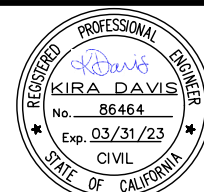

ROAD NAME: ALDERPOINT ROAD	MILE POST: 21.8, 22.8, 23.0-23.05
ROAD NO: F6B165	EA NO.:
PROJECT NO.: ER-32L0(329)	BRIDGE NO: N/A
CONTRACT NO.: 217288	DRAWING FILE NAME:
PLOT DATE: APRIL 2021	REVISION DATE:

<b>MARK THOMAS</b>
DESIGNED BY: CM
DRAWN BY: CM
REVIEWED BY: KD
APPROVED BY:

COUNTY OF HUMBOLDT  
DEPARTMENT OF PUBLIC WORKS  
ALDERPOINT RD STORM DAMAGE (PM 21.8-23.05)

SHEET  
**2**  
OF  
**45**

**BID QUANTITY SUMMARY**

**BID QUANTITY SUMMARY SHEET**

ITEM No.	BEES ITEM NUMBER	ITEM DESCRIPTION	UNIT	LOCATION					TOTAL
				AP 21.8	AP 22.8	AP 23.0	AP 23.05	AP 23.75	
1	100100	DEVELOP WATER SUPPLY	LS	N/A	N/A	N/A	N/A	N/A	1
2	120090	CONSTRUCTION AREA SIGNS	EA	11	5	-	6	-	22
3	120100	TRAFFIC CONTROL SYSTEM	LS	N/A	N/A	N/A	N/A	N/A	1
4	120165	CHANNELIZER (SURFACE MOUNTED)	EA	57	62	61	36	-	216
5	129000	TEMPORARY RAILING (TYPE K)	LF	680	240	340	160	-	1,420
6	129110	TEMPORARY CRASH CUSHION	EA	4	2	2	2	-	10
7	130100	JOB SITE MANAGEMENT	LS	N/A	N/A	N/A	N/A	N/A	1
8	130300	PREPARE STORM WATER POLLUTION PREVENTION PLAN	LS	N/A	N/A	N/A	N/A	N/A	1
9	130310	RAIN EVENT ACTION PLAN	EA	N/A	N/A	N/A	N/A	N/A	20
10	130320	STORM WATER SAMPLING ANALYSIS DAY	DAY	N/A	N/A	N/A	N/A	N/A	6
11	130330	STORM WATER ANNUAL REPORT	EA	N/A	N/A	N/A	N/A	N/A	1
12	130610	TEMPORARY CHECK DAM	LF	-	100	180	80	-	360
13	130620	TEMPORARY DRAINAGE INLET PROTECTION	EA	1	2	1	1	-	5
14	130680	TEMPORARY SILT FENCE	LF	-	290	450	230	-	970
15	130710	TEMPORARY CONSTRUCTION ENTRANCE	EA	1	1	-	-	-	2
16	130900	TEMPORARY CONCRETE WASHOUT	EA	1	1	-	-	-	2
17	170103	CLEARING AND GRUBBING	LS	N/A	N/A	N/A	N/A	N/A	1
18	190101	ROADWAY EXCAVATION	CY	190	3025	5430	2865	-	11,510
19	192049	STRUCTURE EXCAVATION (SOLDIER PILE WALL)	CY	162	-	-	-	-	162
20	193029	STRUCTURE BACKFILL (SOLDIER PILE WALL)	CY	37	-	-	-	-	37
21	193116	CONCRETE BACKFILL (SOLDIER PILE WALL)	CY	40	-	-	-	-	40
22	193119	LEAN CONCRETE BACKFILL	CY	28	-	-	-	-	28
23	198215	SUBGRADE ENHANCEMENT GEOGRID	SY	-	1025	375	300	-	1,700
24	210280	ROLLED EROSION CONTROL PRODUCT (BLANKET)	LF	-	7598	17548	7889	-	33,035
25	210420	STRAW	SF	2185	395	-	-	-	2,580
26	210350	FIBER ROLLS	LF	-	735	1320	575	-	2,630
27	260203	CLASS 2 AGGREGATE BASE	CY	128	189	291	136	-	744
28	390132	HOT MIX ASPHALT (TYPE A)	TON	117	211	322	155	-	805
29	394073	PLACE HOT MIX ASPHALT DIKE (TYPE F)	LF	215	-	-	-	-	215
30	398200	COLD PLANE ASPHALT CONCRETE PAVEMENT	SY	27	33	-	-	-	60
31	460210	GROUND ANCHOR (SUBHORIZONTAL)	EA	15	-	-	-	-	15
32	4903XX	STEEL SOLDIER PILE (W 12 X 65)	LF	642	-	-	-	-	642
33	490400	24" DRILLED HOLE	LF	578	-	-	-	-	578
34	575004	TIMBER LAGGING	MFBM	14	-	-	-	-	14
35	590120	CLEAN AND PAINT STEEL SOLDIER PILING	LS	1	-	-	-	-	1
36	6411XX	8" PLASTIC PIPE	LF	14	-	-	-	-	14
37	665016	18" CORRUGATED STEEL PIPE (0.064" THICK)	LF	42	-	106	122	-	270
38	665022	24" CORRUGATED STEEL PIPE (0.064" THICK)	LF	-	133	-	-	-	133
39	665030	30" CORRUGATED STEEL PIPE (0.064" THICK)	LF	-	62	-	-	-	62
40	680254	CLEANOUT ASSEMBLY	EA	-	3	3	3	-	9
41	680902	6" PERFORATED PLASTIC PIPE UNDERDRAIN	LF	210	332	343	152	-	1,037
42	680905	8" PERFORATED PLASTIC PIPE UNDERDRAIN	LF	112	-	-	-	-	112
43	681990	FILTER FABRIC	SY	-	1570	1065	875	-	3,510
44	682020	CLASS 1 PERMEABLE MATERIAL	CY	-	495	1130	470	-	2,095
45	690122	24" CORRUGATED STEEL PIPE DOWNDRAIN (0.064" THICK)	LF	-	8	-	-	-	8
46	692307	18" ANCHOR ASSEMBLY	EA	1	2	1	1	-	5
47	700637	36" CORRUGATED STEEL PIPE INLET	LF	7	16	8	8	-	39
48	710136	REMOVE PIPE	LF	38	149	-	-	-	187
49	723080	ROCK SLOPE PROTECTION (60 lb, Class II, METHOD B)	CY	3	10	6	6	-	25
50	729011	ROCK SLOPE PROTECTION FABRIC (CLASS 8)	SY	21	52	19	19	-	111
51	750001	MISCELLANEOUS IRON AND STEEL	LB	177	354	177	177	-	885
52	820130	OBJECT MARKER	EA	2	-	-	-	-	2
53	832007	MIDWEST GUARDRAIL SYSTEM (WOOD POST)	LF	113	-	-	-	-	113
54	832070	VEGETATION CONTROL (MINOR CONCRETE)	SY	111	-	-	-	-	111
55	839521	CABLE RAILING	LF	112	-	-	-	-	112
56	839584	ALTERNATIVE IN-LINE TERMINAL SYSTEM	EA	2	-	-	-	-	2
57	840560	THERMOPLASTIC TRAFFIC STRIPE (SPRAYABLE)	LF	415	215	360	170	-	1,160
58	210212	DRY SEED	SF	2185	395	-	-	-	2,580
59	665045	48" CORRUGATED STEEL PIPE (0.064" THICK)	LF	-	-	-	-	60	60
60	999990	MOBILIZATION	LS	N/A	N/A	N/A	N/A	N/A	1

1  
1  
1  
1  
1  
1  
1

Q-1



ADDENDUM No. 1

ROAD NAME: ALDERPOINT RD	DESIGN SECTION: ENGINEERING	<b>COUNTY OF HUMBOLDT</b> <b>DEPARTMENT OF PUBLIC WORKS</b> <b>Attachment 1</b> <b>STORM DAMAGE REPAIR TO ALDERPOINT ROAD PM 23.75</b> <b>PLAN AND PROFILE</b>	SHEET <b>46</b> OF <b>46</b>
ROAD NO.: F6B165	MILE POST: 23.75		
PROJECT NO.: ER-32LO(300)PR	DESIGNED BY:		
CONTRACT NO.: 217294	DRAWN BY: RMD		
DRAWING FILE NAME: 217294 ALD 23.75	REVIEWED BY:		
PLOT DATE: 04/06/2021	REVISION DATE:	APPROVED BY:	



**LAUNER**  
**APN 217-341-009**  
**2014-022198**

CONTROL POINTS				
Point #	Northing	Easting	Elevation	Description
101	5000.00	10000.00	5000.00	SET-80DSPIKE&SHINER
102	4887.91	10036.42	5001.94	SET-GN-SPIKE&TAG-HUMCO-SURVEY
103	5025.34	9900.83	5006.38	SET-80D&TAG-HUMCO-SURVEY
104	5124.85	9835.42	5016.02	SET-GN-SPIKE&TAG-HUMCO-SURVEY

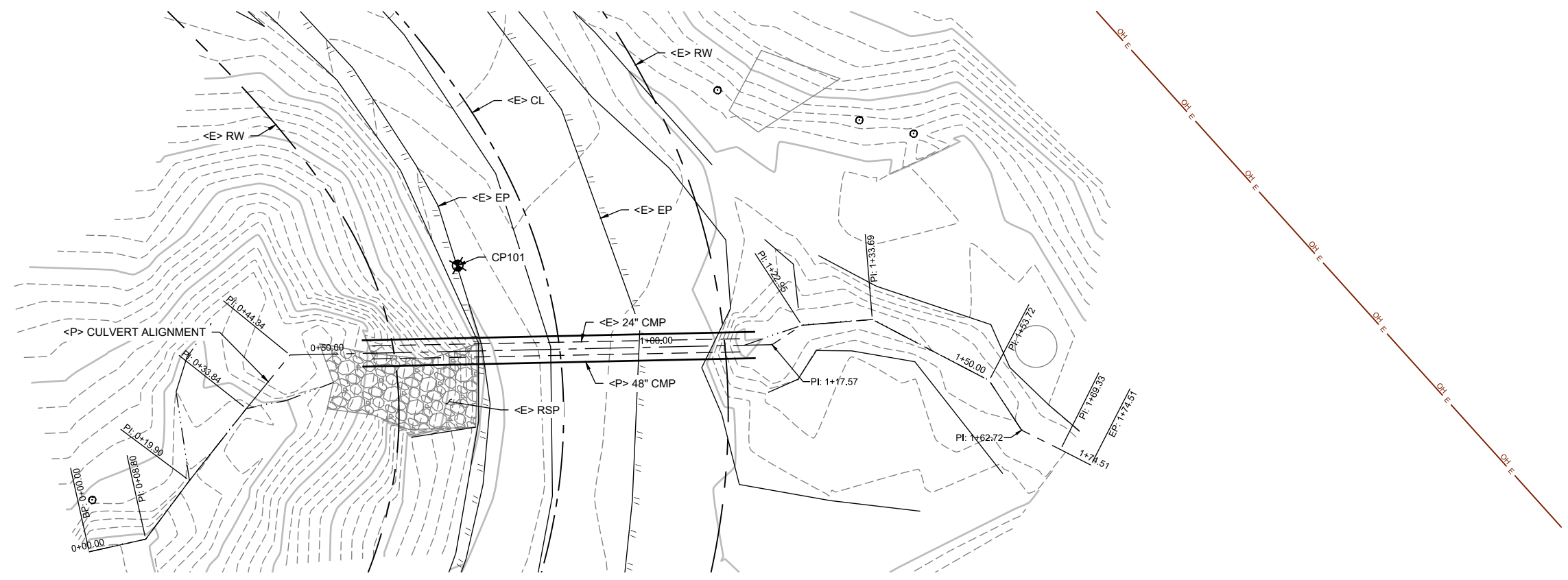

**PLAN VIEW**  
 SCALE: 1"=10'

**BASIS OF BEARINGS NOTE**

THE BEARINGS ARE BASED ON A COMPASS BEARING OF S18°E BETWEEN BENCHMARK NUMBER 101 & 102.

**ELEVATION NOTE**

ELEVATIONS ARE BASED ON AN ASSUMED ELEVATION OF 5000.00' AT BENCHMARK NUMBER 101, BEING A SET 80D SPIKE WITH A SHINER.

**RIGHT OF WAY NOTE**

THE RIGHT OF WAY FOR THIS PROJECT IS 50' WIDE CENTERED ON EXISTING ROAD PER ROAD REGISTER NO. 1, RECORD NO. 119 PAGES 159-175 HUMBOLDT AND MENDOCINO WAGON ROAD AS SURVEYED IN BOOK 2 OF RECORD MAPS PAGES 51 & 52 July 6th 1876.

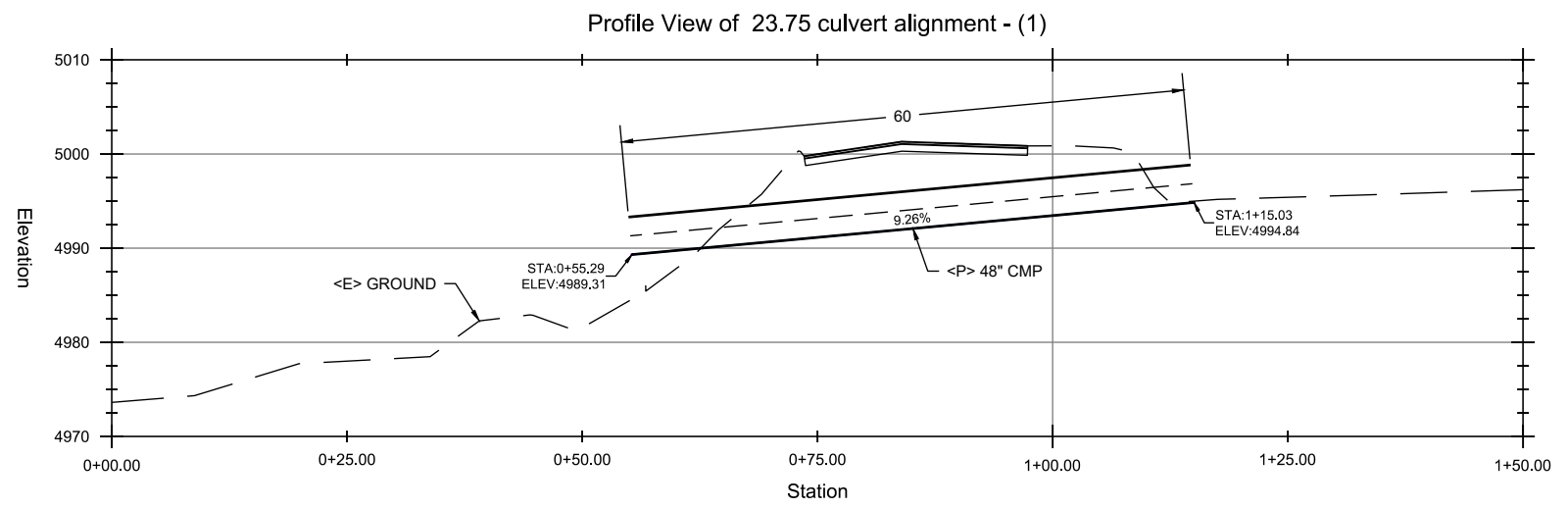

**PROFILE VIEW**  
 SCALE: 1"=10'

**ADDENDUM No. 1**

Attachment 1

**BID FORM (EXHIBIT A) PAGE 1 OF 2**  
**STORM DAMAGE REPAIRS ON ALDERPOINT ROAD**  
**(F6B165) PM 21.8,22.8, 23.0-23.05 & 23.75**  
**PROJECT NO.: ER-32L0(329) & ER-32L0(330)**  
**CONTRACT NO.: 217288 & 217294**

ITEM NO.	ITEM CODE	ITEM DESCRIPTION	UNIT	QTY	UNIT PRICE	TOTAL
1	100100	DEVELOP WATER SUPPLY	LS	1		
2	120090	CONSTRUCTION AREA SIGNS	EA	22		
3	120100	TRAFFIC CONTROL SYSTEM	LS	1		
4	120165	CHANNELIZER (SURFACE MOUNTED)	EA	216		
5	129000	TEMPORARY RAILING (TYPE K)	LF	1,420		
6	129110	TEMPORARY CRASH CUSHION	EA	10		
7	130100	JOB SITE MANAGEMENT	LS	1		
8	130300	PREPARE STORM WATER POLLUTION PREVENTION PLAN	LS	1		
9	130310	RAIN EVENT ACTION PLAN	EA	20		
10	130320	STORM WATER SAMPLING ANALYSIS DAY	DAY	6		
11	130330	STORM WATER ANNUAL REPORT	EA	1		
12	130610	TEMPORARY CHECK DAM	LF	360		
13	130620	TEMPORARY DRAINAGE INLET PROTECTION	EA	5		
14	130680	TEMPORARY SILT FENCE	LF	970		
15	130710	TEMPORARY CONSTRUCTION ENTRANCE	EA	2		
16	130900	TEMPORARY CONCRETE WASHOUT	EA	2		
17	170103	CLEARING AND GRUBBING	LS	1		
18	190101	ROADWAY EXCAVATION	CY	11,510		
19	192049	[F] STRUCTURE EXCAVATION (SOLDIER PILE WALL)	CY	162		
20	193029	[F] STRUCTURE BACKFILL (SOLDIER PILE WALL)	CY	37		
21	193116	[F] CONCRETE BACKFILL (SOLDIER PILE WALL)	CY	40		
22	193119	[F] LEAN CONCRETE BACKFILL	CY	28		
23	198215	SUBGRADE ENHANCEMENT GEOGRID	SY	1,700		
24	210280	ROLLED EROSION CONTROL BLANKET	SQFT	33,035		
25	210420	STRAW	SF	2,580		
26	210350	FIBER ROLLS	LF	2,630		
27	260203	CLASS 2 AGGREGATE BASE	CY	744		
28	390132	HOT MIX ASPHALT (TYPE A)	TON	805		
29	394077	PLACE HOT MIX ASPHALT DIKE (TYPE F)	LF	215		
30	398200	COLD PLANE ASPHALT CONCRETE PAVEMENT	SY	60		
31	460210	[P] GROUND ANCHOR (SUBHORIZONTAL)	EA	15		

**ADDENDUM No. 1  
 BID FORM (EXHIBIT A) PAGE 2 OF 2**

Attachment 1

32	4903XX	[P]	STEEL SOLDIER PILE (W 12 X 65)	LF	642		
33	490400		24" DRILLED HOLE	LF	578		
34	575004	[F]	TIMBER LAGGING	MFBM	14		
35	590120		CLEAN AND PAINT STEEL SOLDIER PILING	LS	1		
36	6411XX	[P]	8" PLASTIC PIPE	LF	14		
37	665016		18" CORRUGATED STEEL PIPE (0.064" THICK)	LF	270		
38	665022		24" CORRUGATED STEEL PIPE (0.064" THICK)	LF	133		
39	665030		30" CORRUGATED STEEL PIPE (0.064" THICK)	LF	62		
40	680254		CLEANOUT ASSEMBLY	EA	9		
41	680902		6" PERFORATED PLASTIC PIPE UNDERDRAIN	LF	1,037		
42	680905		8" PERFORATED PLASTIC PIPE UNDERDRAIN	LF	112		
43	681990		FILTER FABRIC	SY	3,510		
44	682020		CLASS 1 PERMEABLE MATERIAL	CY	2,095		
45	690122		24" CORRUGATED STEEL PIPE DOWNDRAIN (0.064" THICK)	LF	8		
46	692307		18" ANCHOR ASSEMBLY	EA	5		
47	700637		36" CORRUGATED STEEL PIPE INLET	LF	39		
48	710136		REMOVE PIPE	LF	187		
49	723080		ROCK SLOPE PROTECTION (60 lb, Class II, METHOD B)	CY	25		
50	729011		ROCK SLOPE PROTECTION FABRIC (CLASS 8)	SY	111		
51	750001	[F]	MISCELLANEOUS IRON AND STEEL	LB	885		
52	820130		OBJECT MARKER	EA	2		
53	832007		MIDWEST GUARDRAIL SYSTEM (WOOD POST)	LF	113		
54	832070		VEGETATION CONTROL (MINOR CONCRETE)	SY	111		
55	839521	[F]	CABLE RAILING	LF	112		
56	839584		ALTERNATIVE IN-LINE TERMINAL SYSTEM	EA	2		
57	840560		THERMOPLASTIC TRAFFIC STRIPE (SPRAYABLE)	LF	1,160		
58	210212		DRY SEED	SQFT	2,580		
59	665045		48" CORRUGATED STEEL PIPE (0.064" THICK)	LF	60		
60	999990		MOBILIZATION	LS	1		

NOTE: ITEM CODE LETTER DESIGNATION; F= FINAL PAY QUANTITY, P=ITEM ELIGIBLE FOR PARTIAL PAY

**BID TOTAL**

ACKNOWLEDGEMENT OF ADDENDA

<u>ADDENDUM NO.</u> Addendum 1	<u>INITIAL</u>
_____	_____
_____	_____

\_\_\_\_\_  
 (Bidder's Signature)

\_\_\_\_\_  
 (Title)



**County of Humboldt  
Department of Public Works  
1106 Second Street  
Eureka, CA 95501  
TEL (707) 445-7652**

**ADDENDUM NO. 2**

(Issued April 28, 2021)

**STORM DAMAGE REPAIRS TO ALDERPOINT ROAD (F6B165)  
AT PM 21.8, 22.8, 23.0-23.05 & 23.75  
PROJECT NO.: ER-32L0(329) & ER-32L0(330)  
CONTRACT NO.: 217288 & 217294**

The Special Provisions and Plans are hereby modified in accordance with the following:

1. Per **Section 7-1.11A** of the Special Provisions, notice is hereby given that this contract is subject to the Federal Wage Rates as revised on **4/23/2021**, **General Decision Number: CA20210004** ("Revised Wage Rates"). Although the Revised Federal Wage Rates are not required to be physically included in the Bid Package, the Revised Wage Rates shall be included in the Agreement signed by the County of Humboldt and the Contractor. The Revised Wage Rates are available at the Humboldt County Department of Public Works located at 1106 2nd St. Eureka, CA 95501 or directly from the Department of Labor at [https://beta.sam.gov/wage-determination/CA20200004/4?index=wd&keywords=&is\\_active=true&sort=-modifiedDate&date\\_filter\\_index=0&date\\_rad\\_selection=date&wdType=dbra&construction\\_type=Highway&state=CA&county=16336&page=1](https://beta.sam.gov/wage-determination/CA20200004/4?index=wd&keywords=&is_active=true&sort=-modifiedDate&date_filter_index=0&date_rad_selection=date&wdType=dbra&construction_type=Highway&state=CA&county=16336&page=1)

**PROJECT SPECIAL PROVISIONS**

The bid opening date of the Special Provisions shall be revised to May 4, 2021. This change affects the following pages: cover page, 1, 64, & 79.

**I M P O R T A N T**

This Addendum is being sent EMAIL/FAX. To indicate receipt of this Addendum please sign and EMAIL/FAX this page back to the Department of Public Works at (707) 445-7409.

Received by: [Signature] Date 4/28/21  
Company: Granite Construction Company # Pages Received 2

**Total Pages Sent 2**

Approved:



04/28/2021

---

Jason Hickey  
SE 5783

---

Date



County of Humboldt  
Department of Public Works  
1106 Second Street  
Eureka, CA 95501  
TEL (707) 445-7652

**ADDENDUM NO. 3**  
(Issued April 29, 2021)

**STORM DAMAGE REPAIRS TO ALDERPOINT ROAD (F6B165)  
AT PM 21.8, 22.8, 23.0-23.05 & 23.75  
PROJECT NO.: ER-32L0(329) & ER-32L0(330)  
CONTRACT NO.: 217288 & 217294**

The Special Provisions and Plans are hereby modified in accordance with the following:

**PROJECT SPECIAL PROVISIONS**

A revised set of special provisions are attached, which reflects changes in the project title, project number, contract number, engineers estimate, and bid exhibit per the revisions sated in Addendum No. 1 (issued April 6, 2021) and Addendum No. 2 (issued April 28, 2021).

When developing the required bidder's proposal documentation, the contractor shall use the attached revised special provisions.

Approved:

04/29/2021

Jason Hickey  
SE 5783

Date

**I M P O R T A N T**

**This Addendum is being sent EMAIL/FAX. To indicate receipt of this Addendum please sign and EMAIL/FAX this page back to the Department of Public Works at (707) 445-7409.**

Received by:

Date

4-29-21

Company:

Granite Construction Company

# Pages

Received 101

**Total Pages Sent 101**

County of Humboldt • Department of Public Works  
1106 Second Street • Eureka • CA • 95501 • (707) 445-7652



## **SPECIAL PROVISIONS**

NOTICE TO BIDDERS,  
PROPOSAL AND CONTRACT

FOR

**STORM DAMAGE REPAIRS TO ALDERPOINT ROAD  
(F6B165)**

**AT PM 21.8, 22.8, 23.0-23.05 & 23.75**

**ER-32L0(329) & ER-32L0(330)  
CONTRACT NO.: 217288 & 217294**

**120 WORKING DAYS**

FOR USE WITH Standard Specifications dated 2018,  
Standard Plans dated 2018, Prevailing Wage Rates,  
Labor Surcharge and Equipment Rental Rates

**BIDS OPEN: MAY 4, 2021 AT 2:00 PM**

Clerk of the Board's Office  
Humboldt County Courthouse  
825 Fifth Street, Suite 111  
Eureka, CA 95501

**Note:** To register as a plan-holder, prospective bidders must email a request to the Department of Public Works Contact Person. Failure to register as a plan-holder with the Department of Public Works may result in a nonresponsive bid.



# SPECIAL PROVISIONS

NOTICE TO CONTRACTORS,  
PROPOSAL AND CONTRACT

FOR

**STORM DAMAGE REPAIRS ON ALDERPOINT ROAD  
(F6B165)**

**AT PM 21.8, 22.8, 23.0-23.05 & 23.75**

**PROJECT NO.: ER-32L0(329) & ER-32L0(330)**

**CONTRACT NO.: 217288 & 217294**

Prepared for

**County of Humboldt  
Department of Public Works  
1106 Second Street  
Eureka CA 95501**

**Recommended:**

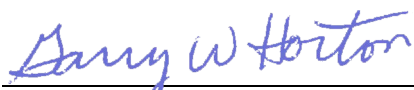

Garry W. Horton  
RCE 30502, Expires 03/31/2022

2/22/2021

Date



Jason B. Hickey  
RSE S5783, Expires 06/30/2022

2/22/2021

Date

## TABLE OF CONTENTS

<b>NOTICE TO BIDDERS .....</b>	<b>1</b>
<b>SPECIAL PROVISIONS.....</b>	<b>4</b>
<b>DIVISION I GENERAL PROVISIONS .....</b>	<b>4</b>
1 GENERAL .....	4
2 BIDDING.....	5
<i>DISADVANTAGED BUSINESS ENTERPRISES (DBE)</i> .....	6
<i>BID OPENING (Required Federal Language)</i> .....	11
<i>BID RIGGING (Required Federal Language)</i> .....	11
3 CONTRACT AWARD AND EXECUTION.....	11
<i>CONTRACT AWARD (Required Federal Language)</i> .....	12
4 SCOPE OF WORK.....	15
5 CONTROL OF WORK .....	16
6 CONTROL OF MATERIALS .....	17
<i>BUY AMERICA (Required Federal Language)</i> .....	17
<i>QUALITY ASSURANCE (Required Federal Language)</i> .....	18
7 LEGAL RELATIONS AND RESPONSIBILITY TO THE PUBLIC .....	18
<i>FEDERAL WAGE RATES</i> .....	18
<i>TITLE VI ASSURANCES (Required Federal Language)</i> .....	19
<i>Appendix E of the Title VI Assurances (US DOT Order 1050.2A)</i> .....	20
<i>FEMALE AND MINORITY GOALS (Required Federal Language)</i> .....	34
<i>FEDERAL TRAINEE PROGRAM (Required Federal Language)</i> .....	35
8 PROSECUTION AND PROGRESS .....	37
9 PAYMENT .....	39
<i>PROMPT PAYMENT FROM THE COUNTY TO THE CONTRACTORS</i> .....	39
<b>DIVISION II GENERAL CONSTRUCTION.....</b>	<b>43</b>
12 TEMPORARY TRAFFIC CONTROL.....	43
13 WATER POLLUTION CONTROL .....	45
14 ENVIRONMENTAL STEWARDSHIP.....	45
<b>DIVISION III EARTHWORK AND LANDSCAPE .....</b>	<b>46</b>
17 GENERAL .....	46
19 EARTHWORK .....	46
21 EROSION CONTROL .....	47
<b>DIVISION IV SUBBASES AND BASES .....</b>	<b>47</b>
26 AGGREGATE BASES .....	47
<b>DIVISION V SURFACINGS AND PAVEMENTS.....</b>	<b>48</b>
39 ASPHALT CONCRETE .....	48
<b>DIVISION VI STRUCTURES.....</b>	<b>50</b>
46 GROUND ANCHORS AND SOIL NAILS .....	50
49 PILING.....	50
59 STRUCTURAL STEEL COATINGS .....	51
<b>DIVISION VII DRAINAGE FACILITIES.....</b>	<b>51</b>
68 SUBSURFACE DRAINS .....	51
<b>DIVISION IX TRAFFIC CONTROL DEVICES .....</b>	<b>51</b>
83 RAILINGS AND BARRIERS.....	51
84 MARKINGS .....	56
<b>DIVISION XI MATERIALS.....</b>	<b>56</b>
96 GEOSYNTHETICS .....	56
<b>PROPOSAL.....</b>	<b>58</b>
BID FORM (EXHIBIT A) PAGE 1 OF 2 .....	61

BID FORM (EXHIBIT A) PAGE 2 OF 2 .....	62
PROPOSAL SIGNATURE PAGE .....	63
BIDDER'S BOND .....	64
CONTRACTOR'S CERTIFICATE REGARDING WORKER'S COMPENSATION.....	65
PUBLIC CONTRACT CODE SECTION 10285.1 STATEMENT .....	66
PUBLIC CONTRACT CODE SECTION 10162 QUESTIONNAIRE.....	66
PUBLIC CONTRACT CODE SECTION 10232 STATEMENT .....	67
DEBARMENT AND SUSPENSION CERTIFICATION .....	68
EQUAL EMPLOYMENT OPPORTUNITY CERTIFICATION.....	69
NONCOLLUSION AFFIDAVIT.....	70
NONLOBBYING CERTIFICATION FOR FEDERAL-AID CONTRACTS .....	71
DISCLOSURE OF LOBBYING ACTIVITIES.....	72
EXHIBIT 12-B: BIDDER'S LIST OF SUBCONTRACTORS (DBE AND NON-DBE) PART 1 .....	74
EXHIBIT 12-B: BIDDER'S LIST OF SUBCONTRACTORS (DBE AND NON-DBE) PART 2 .....	75
EXHIBIT 15-G CONSTRUCTION CONTRACT DBE COMMITMENT .....	76
EXHIBIT 15-H: CONTRACTOR GOOD FAITH EFFORTS.....	79
EXHIBIT 9-F: DISADVANTAGED BUSINESS ENTERPRISE (DBE) RUNNING TALLY OF PAYMENTS.....	82
EXHIBIT 17-F FINAL REPORT-UTILIZATION OF DBE AND FIRST-TIER SUBCONTRACTORS .....	84
EXHIBIT 17-O: DBE CERTIFICATION STATUS CHANGE .....	86
AGREEMENT .....	88
PAYMENT BOND.....	92
PERFORMANCE BOND .....	93

## STANDARD PLANS LIST

The standard plan sheets applicable to this Contract include those listed below. The applicable revised standard plans (RSPs) listed below are included in the project plans.

### ABBREVIATIONS, LINES, SYMBOLS, AND LEGEND

<b>A3A</b>	<b>Abbreviations (Sheet 1 of 3)</b>
<b>A3B</b>	<b>Abbreviations (Sheet 2 of 3)</b>
<b>A3C</b>	<b>Abbreviations (Sheet 3 of 3)</b>
<b>A10A</b>	<b>Legend - Lines and Symbols (Sheet 1 of 5)</b>
<b>A10B</b>	<b>Legend - Lines and Symbols (Sheet 2 of 5)</b>
<b>A10C</b>	<b>Legend - Lines and Symbols (Sheet 3 of 5)</b>
<b>A10D</b>	<b>Legend - Lines and Symbols (Sheet 4 of 5)</b>
<b>A10E</b>	<b>Legend - Lines and Symbols (Sheet 5 of 5)</b>
<b>A10F</b>	<b>Legend - Soil (Sheet 1 of 2)</b>
<b>A10G</b>	<b>Legend - Soil (Sheet 2 of 2)</b>
<b>A10H</b>	<b>Legend - Rock</b>

### PAVEMENT MARKERS, TRAFFIC LINES, AND PAVEMENT MARKINGS

<b>A20A</b>	<b>Pavement Markers and Traffic Lines - Typical Details</b>
<b>RSP A20B</b>	<b>Pavement Markers and Traffic Lines - Typical Details</b>

### EXCAVATION AND BACKFILL

<b>A62A</b>	<b>Excavation and Backfill - Miscellaneous Details</b>
<b>A62B</b>	<b>Limits of Payment for Excavation and Backfill - Bridge Surcharge and Wall</b>
<b>A62C</b>	<b>Limits of Payment for Excavation and Backfill - Bridge</b>
<b>A62F</b>	<b>Excavation and Backfill - Metal and Plastic Culverts</b>

### OBJECT MARKERS, DELINEATORS, CHANNELIZERS, AND BARRICADES

<b>RSP A73A</b>	<b>Object Markers</b>
<b>RSP A73B</b>	<b>Markers</b>
<b>A73C</b>	<b>Delineators, Channelizers and Barricades</b>

### MIDWEST GUARDRAIL SYSTEM - STANDARD RAILING SECTIONS

<b>RSP A77L1</b>	<b>Midwest Guardrail System - Standard Railing Section (Wood Post with Wood Block)</b>
<b>A77M1</b>	<b>Midwest Guardrail System - Standard Hardware</b>
<b>A77N1</b>	<b>Midwest Guardrail System - Wood Post and Wood Block Details</b>
<b>RSP A77N2</b>	<b>Midwest Guardrail System - Steel Post and Notched Wood Block Details</b>
<b>RSP A77N3</b>	<b>Midwest Guardrail System - Typical Line Post Embedment and Hinge Point Offset Details</b>
<b>A77N4</b>	<b>Midwest Guardrail System - Typical Railing Delineation and Dike Positioning Details</b>
<b>A77N5</b>	<b>Midwest Guardrail System - Typical Vegetation Control Standard Railing Section</b>
<b>A77N5A</b>	<b>Midwest Guardrail System - Typical Vegetation Control Standard Railing Section – Narrow Vegetation Control Installation</b>
<b>A77N6</b>	<b>Midwest Guardrail System - Typical Vegetation Control for Terminal System End Treatments</b>

### CURBS, DRIVEWAYS, DIKES, CURB RAMPS, AND ACCESSIBLE PARKING

<b>RSP A87B</b>	<b>Hot Mix Asphalt Dikes</b>
-----------------	------------------------------

	<b>DRAINAGE INLETS, PIPE INLETS AND GRATES</b>
<b>D71</b>	<b>Drainage Inlet Markers</b>
<b>D75A</b>	<b>Steel Pipe Inlets</b>
<b>D75C</b>	<b>Pipe Inlets - Ladder and Trash Rack Details</b>
<b>D77A</b>	<b>Grate Details No. 1</b>
<b>D77B</b>	<b>Grate Details No. 2</b>
	<b>PIPE DOWNDRAINS, ANCHORAGE SYSTEMS AND OVERSIDE DRAINS</b>
<b>D87A</b>	<b>Corrugated Metal Pipe Downdrain Details</b>
	<b>TEMPORARY TRAFFIC CONTROL SYSTEMS</b>
<b>T13</b>	<b>Traffic Control System for Lane Closure on Two Lane Conventional Highways</b>
	<b>TEMPORARY WATER POLLUTION CONTROL</b>
<b>T51</b>	<b>Temporary Water Pollution Control Details (Temporary Silt Fence)</b>
<b>T56</b>	<b>Temporary Water Pollution Control Details (Temporary Fiber Roll)</b>
<b>T57</b>	<b>Temporary Water Pollution Control Details (Temporary Check Dam)</b>
<b>T58</b>	<b>Temporary Water Pollution Control Details (Temporary Construction Entrance)</b>
<b>T59</b>	<b>Temporary Water Pollution Control Details (Temporary Concrete Washout Facility)</b>
<b>T60</b>	<b>Temporary Water Pollution Control Details (Temporary Reinforced Silt Fence)</b>
<b>T61</b>	<b>Temporary Water Pollution Control Details (Temporary Drainage Inlet Protection)</b>
<b>T62</b>	<b>Temporary Water Pollution Control Details (Temporary Drainage Inlet Protection)</b>
<b>T63</b>	<b>Temporary Water Pollution Control Details (Temporary Drainage Inlet Protection)</b>
<b>T64</b>	<b>Temporary Water Pollution Control Details (Temporary Drainage Inlet Protection)</b>
	<b>CHAIN LINK RAILING, CABLE RAILING AND TUBULAR HAND RAILING</b>
<b>B11-47</b>	<b>Cable Railing</b>



COUNTY OF HUMBOLDT  
DEPARTMENT OF PUBLIC WORKS

**NOTICE TO BIDDERS**

Sealed proposals will be received by (and all bids should be mailed or delivered to) the

**Clerk of the Board Office**  
**SEALED BID for (Project Name)**  
Humboldt County Courthouse  
825 Fifth Street, Suite 111  
Eureka, California, 95501

until 2:00 PM, **TUESDAY, MAY 4, 2021**, at which time they will be publicly opened by the Clerk of the Board of the County of Humboldt at a public meeting in the Office of the Clerk of the Board of Supervisors, Humboldt County Courthouse, Eureka, California, for performing work as follows:

**STORM DAMAGE REPAIRS TO ALDERPOINT ROAD**  
**(F6B165)**  
**AT PM 21.8, 22.8, 23.0-23.05 & 23.75**  
**ER-32L0(329) & ER-32L0(330)**  
**CONTRACT NO.: 217288 & 217294**

Bids are required for the entire work as described herein:

The roadwork to be done consists, in general, of, traffic control, clearing and grubbing, removing, adjusting or reconstructing existing facilities, reconstructing and widening pavement, installing new retaining wall, installing drainage, placing thermoplastic stripes and pavement markings and infill paving. This work also includes temporary water pollution control, as needed. Bidders are advised that the work must be completed within **120 working days**. The Engineer's Estimate for this work is: **\$2,819,398**.

Plans, Special Provisions and Proposal Forms may be viewed at the Humboldt County Department of Public Works, 1106 Second Street, Eureka, California, 95501, at area plan centers and on the County's website at: <http://humboldt.gov/Bids.aspx>.

To receive electronic bid documents and to **register as a plan-holder**, prospective bidders must email a request to the following project contact: Patricia Sennott, Department of Public Works Office Assistant, [PSennott@co.humboldt.ca.us](mailto:PSennott@co.humboldt.ca.us), (707) 445-7652. Failure to register as a plan-holder with Department of Public Works may result in a nonresponsive bid.

Printed copies of the contract documents may be obtained by prospective Bidders upon ADVANCE payment of a non-refundable printing and service charge in the amount of \$15.00. All checks shall be made payable to COUNTY OF HUMBOLDT and should be mailed along with the request for Plans to the Humboldt County Department of Public Works, 1106 Second Street, Eureka, California, 95501.

Telephone: (707) 445-7652 Requests for plans, planholder list or project estimate  
(707) 445-7377 Engineering division, questions regarding plans or specs  
(707) 445-7409 Fax transmissions

Plans and Special Provisions reference the Caltrans Standard Specifications and Standard Plans dated 2018. Provisions that reference federal-aid contracts are applicable.

The successful Bidder shall furnish a Payment Bond and a Performance Bond.

The Contractor shall possess a **CLASS "A"** Contractors License at the time this contract is awarded.

No pre-bid meeting is scheduled for this project.

This contract is subject to state contract nondiscrimination and compliance requirements pursuant to Government Code, Section 12990. The County of Humboldt affirms that in any contract entered into pursuant to this advertisement, Disadvantaged Business Enterprises, as defined in 49 CFR Part 26, will be afforded full opportunity to submit bids in response to this invitation.

For this contract, the County has included a Disadvantaged Business Enterprises (DBE) goal of **8 Percent**. Bidders need not achieve the percentage stated as a condition of award.

Inquiries or questions based on alleged patent ambiguity of the plans, specifications or estimate must be communicated as a bidder inquiry prior to bid opening. Any such inquiries or questions, submitted after bid opening, will not be treated as a bid protest.

Pursuant to Section 1773 of the Labor Code, the general prevailing wage rates in the county, or counties, in which the work is to be done have been determined by the Director of the California Department of Industrial Relations. These wages are set forth in the General Prevailing Wage Rates for this project, available at County of Humboldt, 1106 2<sup>nd</sup> Street, Eureka, CA. 95501 and available from the California Department of Industrial Relations' Internet web site at <http://www.dir.ca.gov/DLSR/PWD>. The Federal minimum wage rates for this project as predetermined by the United States Secretary of Labor are available on the web home page of the Department of Labor at <https://beta.sam.gov/> and copies may be examined at the offices described above where project plans, special provisions, and proposal forms may be seen. Addenda to modify the Federal minimum wage rates, if necessary, will be issued to planholders that have purchased bid documents from the Department of Public Works at 1106 Second Street, Eureka, California, 95501. Future effective general prevailing wage rates which have been predetermined and are on file with the California Department of Industrial Relations are referenced but not printed in the general prevailing wage rates.

Attention is directed to the Federal minimum wage rate requirements of the Department of Labor. If there is a difference between the minimum wage rates predetermined by the Secretary of Labor and the general prevailing wage rates determined by the Director of the California Department of Industrial Relations for similar classifications of labor, the Contractor and subcontractors shall pay

not less than the higher wage rate. The Department will not accept lower State wage rates not specifically included in the Federal minimum wage determinations. This includes "helper" (or other classifications based on hours of experience) or any other classification not appearing in the Federal wage determinations. Where Federal wage determinations do not contain the State wage rate determination otherwise available for use by the Contractor and subcontractors, the Contractor and subcontractors shall pay not less than the Federal minimum wage rate which most closely approximates the duties of the employees in question.

This project is subject to the "Buy America" provisions of the Surface Transportation Act of 1982, as amended by the Intermodal Surface Transportation Efficiency Act of 1991 (ISTEA) Sections 1041(a) and 1048(a), and the regulations adopted pursuant thereto.

The U.S. Department of Transportation (DOT) provides a toll-free hotline to report bid rigging activities. Use the hotline to report bid rigging, bidder collusion, and other fraudulent activities. The hotline number is (800) 424-9071. The service is available 24 hours 7 days a week and is confidential and anonymous. The hotline is part of the DOT's effort to identify and investigate highway construction contract fraud and abuse and is operated under the direction of the DOT Inspector General.

KATHY HAYES

Clerk of the Board of Supervisors

County of Humboldt, State of California

DATED: \_\_\_\_\_





COUNTY OF HUMBOLDT  
DEPARTMENT OF PUBLIC WORKS

**SPECIAL PROVISIONS  
FOR**

**STORM DAMAGE REPAIRS TO ALDERPOINT ROAD (F6B165)  
AT PM 21.8, 22.8, 23.0-23.05 & 23.75  
ER-32L0(329) & ER-32L0(330)  
CONTRACT NO.: 217288 & 217294**

**DIVISION I GENERAL PROVISIONS**

**1 GENERAL**

*Add to section 1-1.01:*

The work embraced herein shall be done in accordance with the **STANDARD SPECIFICATIONS dated 2018**, and the **STANDARD PLANS dated 2018**, and revisions thereto, of the State of California, Department of Transportation insofar as the same may apply and in accordance with the following special provisions. In case of conflict between the Standard Specifications and these special provisions, the special provisions shall take precedence over and be used in lieu of such conflicting portions.

All bid proposals and materials submitted in response to this Notice to Bidders shall become the County's property and are subject to disclosure under the Public Records Act, California Government Code Sections 6250, et seq. All bid proposals submitted in response hereto, are considered public information, except for specifically identified trade secrets, which will be handled according to any and all applicable local, state and federal laws and regulations. Any portion of a bid proposal that is deemed to be a trade secret by the bidder shall be clearly marked "PROPRIETARY INFORMATION" at the top of the page in at least one-half inch (1/2") letters. Specifically identified proprietary information will not be released, if the bidder agrees to indemnify and defend the County in any action brought to disclose such information. By submitting a bid proposal in response to this Notice to Bidders, the bidder agrees that the County's failure to contact the bidder prior to the release of any proprietary information contained therein will not be a basis for liability by the County or any employee thereof. Items considered public information will be available for review after the bid opening.

*Replace the following definitions in section 1-1.07B with:*

**DEPARTMENT, DIRECTOR:** Humboldt County Department of Public Works.

**ENGINEER:** The Director of Public Works of Humboldt County or his authorized agent working within the scope of his authority.

**STATE:** County of Humboldt, a political subdivision of the State of California.

*Add to section 1-1.07B:*

**LABORATORY:** Materials and Testing Laboratory of the Humboldt County Department of Public Works.

^^

**2 BIDDING**

*Add to section 2-1.06A:*

Plans, Special Provisions (not including documents included by reference) and Proposal Forms may be viewed by prospective Bidders at the Humboldt County Department of Public Works, 1106 Second Street, Eureka, California.

Plans, Special Provisions and Supplemental Project Information may be viewed on the County of Humboldt web site: [www.co.humboldt.ca.us](http://www.co.humboldt.ca.us). Current Revised Standard Specifications are available for review at the Department of Public Works, 1106 Second Street, Eureka, California or on Caltrans web page of the Office Engineer/ Engineering. (<http://www.dot.ca.gov/hq/esc/oe/standards.php>)

Note that Plans, Special Provisions, and Proposal Forms posted on the County’s web site may be used to submit a bid, however prospective bidders must register as a plan-holder. Failure to register as a plan-holder with the Department of Public Works may result in a nonresponsive bid.

To **register as a plan-holder**, prospective bidder may email a request to the following project contact: Patricia Sennott, Department of Public Works Office Assistant, [PSennott@co.humboldt.ca.us](mailto:PSennott@co.humboldt.ca.us), (707) 445-7652 or the engineering division (707) 445-7377.

***Add between the 1st and 2nd paragraphs of section 2-1.06B:***

The Department makes the following supplemental project information available:

**Supplemental Project Information**

Means	Description
Available for inspection at the Public Works Office: 1106 2 <sup>nd</sup> Street Eureka, CA 95501 Telephone No.: (707)445-7377  And available for inspection at: <a href="http://www.co.humboldt.ca.us">www.co.humboldt.ca.us</a> .	<ul style="list-style-type: none"> <li>• Geotechnical Report and Log of Test Borings - Alderpoint Road Failure at PM 21.8, dated August 2020</li> <li>• Geotechnical Report and Log of Test Borings - Alderpoint Road Failure at PM 22.8, dated August 2020</li> <li>• Geotechnical Report and Log of Test Borings - Alderpoint Road Failure at PM 23.0 and 23.05, dated August 2020</li> </ul>

***Add to section 2-1.12B:*****DISADVANTAGED BUSINESS ENTERPRISES (DBE)**

(Required Federal Language)

The contractor, subrecipient or subcontractor shall take necessary and reasonable steps to ensure that DBEs have opportunity to participate in the contract (49 CFR 26). To ensure equal participation of DBEs provided in 49 CFR 26.5, the County shows a contract goal for DBEs. The prime contractor shall make work available to DBEs and select work parts consistent with available DBE subcontractors and suppliers.

The prime contractor shall meet the DBE goal shown elsewhere in these special provisions or demonstrate that they made adequate good faith efforts to meet this goal.

It is the prime contractor's responsibility to verify that the DBE firm is certified as DBE at date of bid opening and document the record by printing out the California Unified Certification Program (CUCP) data for each DBE firm. A list of DBEs certified by the CUCP can be found at <https://dot.ca.gov/programs/civil-rights/dbe-search>.

All DBE participation will count toward the California Department of Transportation's federally mandated statewide overall DBE goal.

Credit for materials or supplies the prime contractor purchases from DBEs counts towards the goal in the following manner:

- 100 percent counts if the materials or supplies are obtained from a DBE manufacturer.
- 60 percent counts if the materials or supplies are obtained from a DBE regular dealer.
- Only fees, commissions, and charges for assistance in the procurement and delivery of materials or supplies count if obtained from a DBE that is neither a manufacturer nor regular dealer. 49 CFR 26.55 defines "manufacturer" and "regular dealer."

The prime contractor receives credit towards the goal if they employ a DBE trucking company that performs a commercially useful function as defined in 49 CFR 26.55(d)(1) as follows:

- The DBE must be responsible for the management and supervision of the entire trucking operation for which it is responsible on a particular contract, and there cannot be a contrived arrangement for the purpose of meeting DBE goals.
- The DBE must itself own and operate at least one fully licensed, insured, and operational truck used on the contract.
- The DBE receives credit for the total value of the transportation services it provides on the Contract using trucks it owns, insures, and operates using drivers it employs.
- The DBE may lease trucks from another DBE firm, including an owner-operator who is certified as a DBE. The DBE who leases trucks from another DBE receives credit for the total value of the transportation services the lessee DBE provides on the Contract.
- The DBE may lease trucks without drivers from a non-DBE truck leasing company. If the DBE leases trucks from a non-DBE truck leasing company and uses its own employees as drivers, it is entitled to credit for the total value of these hauling services.
- A lease must indicate that the DBE has exclusive use of and control over the truck. This does not preclude the leased truck from working for others during the term of the lease with the consent of the DBE, so long as the lease gives the DBE absolute priority for use of the leased truck. Leased trucks must display the name and identification number of the DBE.

#### **A. Nondiscrimination Statement**

The contractor, subrecipient or subcontractor will never exclude any person from participation in, deny any person the benefits of, or otherwise discriminate against anyone in connection with the award and performance of any contract covered by 49 CFR 26 on the basis of race, color, sex, or national origin. In administering the County components of the DBE Program Plan, the contractor, subrecipient or subcontractor will not, directly, or through contractual or other arrangements, use criteria or methods of administration that have the effect of defeating or substantially impairing accomplishment of the objectives of the DBE Program Plan with respect to individuals of a particular race, color, sex, or national origin.

#### **B. Contract Assurance**

Under 49 CFR 26.13(b):

The contractor, subrecipient or subcontractor shall not discriminate on the basis of race, color, national origin, or sex in the performance of this contract. The contractor shall carry out applicable requirements of 49 CFR 26 in the award and administration of federal-aid contracts. Failure by the contractor to carry out these requirements is a material breach of this contract, which may result in the termination of this contract or such other remedy as the recipient deems appropriate, which may include, but is not limited to:

1. Withholding monthly progress payments;
2. Assessing sanctions;
3. Liquidated damages; and/or

4. Disqualifying the contractor from future bidding as non-responsible.

### **C. Prompt Progress Payment**

The prime contractor or subcontractor shall pay to any subcontractor, not later than **seven days** after receipt of each progress payment, unless otherwise agreed to in writing, the respective amounts allowed the contractor on account of the work performed by the subcontractors, to the extent of each subcontractor's interest therein. In the event that there is a good faith dispute over all or any portion of the amount due on a progress payment from the prime contractor or subcontractor to a subcontractor, the prime contractor or subcontractor may withhold no more than 150 percent of the disputed amount. Any violation of this requirement shall constitute a cause for disciplinary action and shall subject the licensee to a penalty, payable to the subcontractor, of 2 percent of the amount due per month for every month that payment is not made.

In any action for the collection of funds wrongfully withheld, the prevailing party shall be entitled to his or her attorney's fees and costs. The sanctions authorized under this requirement shall be separate from, and in addition to, all other remedies, either civil, administrative, or criminal. This clause applies to both DBE and non-DBE subcontractors.

### **D. Prompt Payment of Withheld Funds to Subcontractors**

No retainage will be held by County from progress payments due to prime contractor. Prime contractors and subcontractors are prohibited from holding retainage from subcontractors. Any delay or postponement of payment may take place only for good cause and with the County's prior written approval. Any violation of this provision shall subject the violating prime contractor or subcontractor to the penalties, sanctions, and other remedies specified in Section 7108.5 of the California Business and Professions Code and Section 10262 of the California Public Contract Code. This provision shall not be construed to limit or impair any contractual, administrative or judicial remedies, otherwise available to the prime contractor or subcontractor in the event of a dispute involving late payment or nonpayment by prime contractor, deficient subcontractor performance and/or noncompliance by a subcontractor. This provision applies to both DBE and non-DBE subcontractors.

### **E. Termination and Substitution of DBE Subcontractors**

The prime contractor shall utilize the specific DBEs listed to perform the work and supply the materials for which each is listed unless the contractor obtains the County's written consent. The prime contractor shall not terminate or substitute a listed DBE for convenience and perform the work with their own forces or obtain materials from other sources without prior written authorization from the County. Unless the County's prior written consent is provided, the contractor shall not be entitled to any payment for work or material unless it is performed or supplied by the listed DBE on the Exhibit 15-G Construction Contract DBE Commitment form, included in the Bid.

The County authorizes a request to use other forces or sources of materials if the bidder shows any of the following justifications:

1. Listed DBE fails or refuses to execute a written contract based on plans and specifications for the project.

2. The County stipulated that a bond is a condition of executing the subcontract and the listed DBE fails to meet the County's bond requirements.
3. Work requires a contractor's license and listed DBE does not have a valid license under Contractors License Law.
4. Listed DBE fails or refuses to perform the work or furnish the listed materials (failing or refusing to perform is not an allowable reason to remove a DBE if the failure or refusal is a result of bad faith or discrimination).
5. Listed DBE's work is unsatisfactory and not in compliance with the contract.
6. Listed DBE is ineligible to work on the project because of suspension or debarment.
7. Listed DBE becomes bankrupt or insolvent.
8. Listed DBE voluntarily withdraws with written notice from the Contract
9. Listed DBE is ineligible to receive credit for the type of work required.
10. Listed DBE owner dies or becomes disabled resulting in the inability to perform the work on the Contract.
11. The County determines other documented good cause.

The prime contractor shall notify the original DBE of the intent to use other forces or material sources and provide the reasons, allowing the DBE 5 days to respond to the notice and advise the prime contractor and the County of the reasons why the use of other forces or sources of materials should not occur.

The prime contractor's request to use other forces or material sources must include:

1. One or more of the reasons listed in the preceding paragraph.
2. Notices from the prime contractor to the DBE regarding the request.
3. Notices from the DBEs to the prime contractor regarding the request.

If a listed DBE is terminated or substituted, the prime contractor must make good faith efforts to find another DBE to substitute for the original DBE. The substitute DBE must perform at least the same amount of work as the original DBE under the contract to the extent needed to meet or exceed the DBE goal.

## **F. Commitment and Utilization**

Note: In the County's reports of DBE participation to Caltrans, the County must display both commitments and attainments.

The County's DBE program must include a monitoring and enforcement mechanism to ensure that DBE commitments reconcile to DBE utilization.

The bidder shall submit the Exhibit 15-G Construction Contract DBE Commitment, included in the Bid book. This exhibit is the bidder's DBE commitment form. If the form is not submitted with the bid, the bidder must remove the form from the Bid book before submitting their bid.

The bidder shall complete and sign Exhibit 15-G Construction Contract DBE Commitment included in the contract documents regardless of whether DBE participation is reported. The bidder shall provide written confirmation from each DBE that the DBE is participating in the Contract. A copy of a DBE's quote serves as written confirmation. If a DBE is participating as a joint venture partner, the bidder shall submit a copy of the joint venture agreement.

If the DBE Commitment form, Exhibit 15-G, is not submitted with the bid, it must be completed and submitted by all bidders to the County within five (5) days of bid opening. If the bidder does not submit the DBE Commitment form within the specified time, the County will find the bidder's bid nonresponsive.

The prime contractor shall use each DBE subcontractor as listed on Exhibit 12-B Bidder's List of Subcontractors (DBE and Non-DBE), and Exhibit 15-G Construction Contract DBE Commitment form unless they receive authorization for a substitution.

The County shall request the prime contractor to:

1. Notify the Resident Engineer or Inspector of any changes to its anticipated DBE participation
2. Provide this notification before starting the affected work
3. Maintain records including:
  - Name and business address of each 1<sup>st</sup>-tier subcontractor
  - Name and business address of each DBE subcontractor, DBE vendor, and DBE trucking company, regardless of tier
  - Date of payment and total amount paid to each business (see Exhibit 9-F Monthly Disadvantaged Business Enterprise Payment)

If the prime contractor is a DBE contractor, they shall include the date of work performed by their own forces and the corresponding value of the work.

Before the 15th of each month, the prime contractor shall submit a Monthly DBE Trucking Verification (LAPM Exhibit 16-Z1) form.

If a DBE is decertified before completing its work, the DBE must notify the prime contractor in writing of the decertification date. If a business becomes a certified DBE before completing its work, the business must notify the prime contractor in writing of the certification date. The prime contractor shall submit the notifications. Upon work completion, the prime contractor shall complete a Disadvantaged Business Enterprises (DBE) Certification Status Change, Exhibit 17-O, form and submit the form within 30 days of contract acceptance.

Upon work completion, the prime contractor shall complete Exhibit 17-F Final Report – Utilization of Disadvantaged Business Enterprises (DBE), First-Tier Subcontractors and submit it within 90

days of contract acceptance. The County will withhold \$10,000 until the form is submitted. The County releases the withhold upon submission of the completed form.

**G. DBE Running Tally of Attainments**

After submitting an invoice for reimbursement that includes a payment to a DBE, but no later than the 10th of the following month, the prime contractor/consultant shall complete and email the Exhibit 9-F: Disadvantaged Business Enterprise Running Tally of Payments to [business.support.unit@dot.ca.gov](mailto:business.support.unit@dot.ca.gov) with a copy to the County.

***Add to section 2-1.33A:***

The following table lists the forms that are included in the Proposal Section of these special provisions:

<b>Table of Forms</b>	
Form	Description
Exhibit 12B Part 1	List of Subcontractors (DBE & Non DBE)
Exhibit 12B Part 2	List of Subcontractors (DBE & Non DBE)
Exhibit 15G	DBE Commitment
Exhibit 15H	DBE Good Faith Effort

***Add to section 2-1.34:***

The form "Bidder's Bond" can be found following the signature page of the Proposal.

***Add to section 2-1.43:***

**BID OPENING** (Required Federal Language)

The County publicly opens and reads bids at the time and place shown on the Notice to Bidders.

***Add to section 2-1.50:***

**BID RIGGING** (Required Federal Language)

The U.S. Department of Transportation (DOT) provides a toll-free hotline to report bid rigging activities. Use the hotline to report bid rigging, bidder collusion, and other fraudulent activities. The hotline number is (800) 424-9071. The service is available 24 hours 7 days a week and is confidential and anonymous. The hotline is part of the DOT's effort to identify and investigate highway construction contract fraud and abuse and is operated under the direction of the DOT Inspector General.

^^

**3 CONTRACT AWARD AND EXECUTION**

***Replace the 1st paragraph in section 3-1.04 with:***



Bid Protest. Any bid protest must be in writing and must be received by the Department Director at 1106 Second Street, Eureka, CA, 95501 (Fax: (707) 445-7409), before 5:00 p.m. no later than three (3) working days following bid opening (the “Bid Protest Deadline”) and must comply with the following requirements:

1. Only a bidder who has actually submitted a Bid Proposal is eligible to submit a bid protest against another bidder. Subcontractors are not eligible to submit bid protests. A bidder may not rely on the bid protest submitted by another bidder, but must timely pursue its own protest.
2. The bid protest must contain a complete statement of the basis for the protest and all supporting documentation. Material submitted after the Bid Protest Deadline will not be considered. The protest must refer to the specific portion or portions of the Contract Documents upon which the protest is based. The protest must include the name, address and telephone number of the person representing the protesting bidder if different from the protesting bidder.
3. A copy of the protest and all supporting documents must also be transmitted by fax or by e-mail, by or before the Bid Protest Deadline, to the protested bidder and any other bidder who has a reasonable prospect of receiving an award depending upon the outcome of the protest.
4. The protested bidder may submit a written response to the protest, provided the response is received by the Department Director before 5:00 p.m., within two (2) working days after the Bid Protest Deadline or after receipt of the bid protest, whichever is sooner (the “Response Deadline”). The response must include all supporting documentation. Material submitted after the Response Deadline will not be considered. The response must include the name, address and telephone number of the person representing the protested bidder if different from the protested bidder.
5. The procedure and time limits set forth in this section are mandatory and are the bidder’s sole and exclusive remedy in the event of bid protest. The bidder’s failure to comply with these procedures shall constitute a waiver of any right to further pursue a bid protest, including filing a Government Code Claim or initiation of legal proceedings. Any addenda or bulletins issued during the time of bidding, or forming a part of the documents issued to the Bidder for the preparation of his bid, shall be covered in the bid, and shall become a part of the Agreement.

Any addenda or bulletins issued during the time of bidding, or forming a part of the documents issued to the Bidder for the preparation of his bid, shall be covered in the bid, and shall become a part of the Agreement.

No person, firm or corporation shall be allowed to make or file, or be interested in, more than one bid for the same work, unless alternate bids are called for. A person, firm, or corporation who has submitted a subproposal to a Bidder, or who has quoted prices on materials to a Bidder, is not thereby disqualified from submitting a subproposal or quoting prices to other Bidders.

***Replace the 2nd paragraph in section 3-1.04 with:***  
**CONTRACT AWARD (Required Federal Language)**

If the County awards the contract, the award is made to the lowest responsible and responsive bidder.

***Replace section 3-1.05:***

The successful Bidder, simultaneously with the execution of the Agreement, will be required to furnish a **Payment Bond** in an amount equal to **one hundred (100%) percent** of the contract price, and a faithful **Performance Bond** in an amount equal to **one hundred (100%)** of the contract price; said Bonds shall be secured from a surety company satisfactory to the Humboldt County Board of Supervisors. The Payment Bond shall comply with Section 3248 of the Civil Code of the State of California. The Payment Bond and the faithful Performance Bond shall each be in a form which is satisfactory to the County Counsel of the County of Humboldt. A copy of an acceptable format is attached to the Agreement forms included in the proposal section of these specifications.

***Replace section 3-1.06 with:***

**CONTRACTOR LICENSE (Required Federal Language)**

The Contractor must be properly licensed as a contractor from contract award through Contract acceptance (Public Contract Code § 10164).

***Replace section 3-1.07 with:***

- I. THIS CONTRACT/AGREEMENT SHALL NOT BE EXECUTED BY COUNTY and the CONTRACTOR is not entitled to any rights, unless certificates of insurance, or other sufficient proof that the following provisions have been complied with, and such certificate(s) are filed with the Clerk of the Humboldt County Board of Supervisors.
- II. Without limiting Contractor's indemnification provided herein, Contractor shall and shall require any of its subcontractors to take out and maintain, throughout the period of this Agreement, the following policies of insurance placed with insurers with a current A.M. Bests rating of no less than A:VII or its equivalent against injury/death to persons or damage to property which may arise from or in connection with the activities hereunder of Contractor, its agents, employees or subcontractors:
  - A. Comprehensive or Commercial General Liability Insurance at least as broad as Insurance Services Office Commercial General Liability coverage (occurrence from CG 0001), in an amount of \$1,000,000 per occurrence. If work involves explosive, underground or collapse risks, XCU must be included. If a general aggregate limit is used, either the general aggregate limit shall apply separately to this project or the general aggregate shall be twice the required occurrence limit. Said policy shall contain, or be endorsed with, the following provisions:
    - (1) The County, its officers, employees and agents, are covered as additional insured for liability arising out of the operations performed by or on behalf of Contractor. The coverage shall contain no special limitations on the scope of protection afforded to the County, its officers, agents, and employees.
    - (2) The policy shall not be canceled or materially reduced in coverage without thirty (30) days prior written notice (10 days for non-payment of the premium) to County by certified mail.

- (3) The inclusion of more than one insured shall not operate to impair the rights of one insured against another insured, and the coverage afforded shall apply as though separate policies had been issued to each insured, but the inclusion of more than one insured shall not operate to increase the limits of the insurer's liability.
  - (4) For claims related to this project, the Contractor's insurance is primary coverage to the County, and any insurance or self-insurance programs maintained by the County are excess to Contractor's insurance and will not be called upon to contribute with it.
  - (5) Any failure to comply with reporting or other provisions of the parties, including breach of warranties, shall not affect coverage provided to County, its officers, employees, and agents.
- B. Automobile liability insurance with coverage at least as broad as Insurance Services Office form CA 0001 06092, Code 1 (any auto), for vehicles used in the performance of this Agreement with minimum coverage of not less than \$1,000,000 per accident combined single limit (CSL). Such policy shall contain or be endorsed with the provision that coverage shall not be canceled or materially reduced in coverage without thirty (30) days prior written notice (10 days for non-payment of premium) to County by certified mail.
  - C. Workers' Compensation insurance meeting statutory limits of the California Labor Code which policy shall contain or be endorsed to contain a waiver of subrogation against County, its officers, agents, and employees and provide for thirty (30) days prior written notice in the event of cancellation.
  - D. Contractor shall furnish County with certificates and original endorsements effecting the required coverage prior to execution of this Agreement by County. The endorsements shall be on forms as approved by the County's Risk Manager or County Counsel. Any deductible or self-insured retention over \$100,000 shall be disclosed to and approved by County. If Contractor does not keep all required policies in full force and effect, County may, in addition to other remedies under this Agreement, take out the necessary insurance, and Contractor agrees to pay the cost of said insurance.

The County may elect to treat a failure to maintain the requisite insurances as a breach of contract/agreement and terminate the contract/agreement as provided herein.

- III. Contractor shall indemnify and hold harmless County and its Board, officers, officials, employees, and volunteers from and against all claims, damages, losses, and expenses including attorney fees arising out of the performance of the work described herein, caused in whole or in part by any negligent act or omission by the contractor, any subcontractor, anyone directly or indirectly employed by any of them or anyone for whose acts any of them may be liable, except where caused by the active negligence, sole negligence, or willful misconduct of the County.

***Replace the 2nd and 3rd paragraph in section 3-1.18 with:***

The form of Agreement which the successful Bidder, as Contractor, will be required to execute, is included in the contract documents and should be carefully examined by the bidder. The agreement and bonds will be executed in duplicate. The signed agreements and bonds together with the

required insurance certificates are to be returned by the successful bidder within 7 days, not including Sundays and legal holidays, after the bidder has received the contract for execution.

^^

#### 4 SCOPE OF WORK

*Add to section 4-1.06:*

##### **CHANGED CONDITIONS** (Required Federal Language)

**A. Differing Site Conditions**

1. During the progress of the work, if subsurface or latent physical conditions are encountered at the site differing materially from those indicated in the contract or if unknown physical conditions of an unusual nature, differing materially from those ordinarily encountered and generally recognized as inherent in the work provided for in the contract, are encountered at the site, the party discovering such conditions shall promptly notify the other party in writing of the specific differing conditions before the site is disturbed and before the affected work is performed.
2. Upon written notification, the engineer will investigate the conditions, and if it is determined that the conditions materially differ and cause an increase or decrease in the cost or time required for the performance of any work under the contract, an adjustment, excluding anticipated profits, will be made and the contract modified in writing accordingly. The engineer will notify the contractor of the determination whether or not an adjustment of the contract is warranted.
3. No contract adjustment which results in a benefit to the contractor will be allowed unless the contractor has provided the required written notice.
4. No contract adjustment will be allowed under this clause for any effects caused on unchanged work.

**B. Suspensions of Work Ordered by the Engineer**

1. If the performance of all or any portion of the work is suspended or delayed by the engineer in writing for an unreasonable period of time (not originally anticipated, customary, or inherent to the construction industry) and the contractor believes that additional compensation and/or contract time is due as a result of such suspension or delay, the contractor shall submit to the engineer in writing a request for adjustment within 7 calendar days of receipt of the notice to resume work. The request shall set forth the reasons and support for such adjustment.
2. Upon receipt, the engineer will evaluate the contractor's request. If the engineer agrees that the cost and/or time required for the performance of the contract has increased as a result of such suspension and the suspension was caused by conditions beyond the control of and not the fault of the contractor, its suppliers, or subcontractors at any approved tier, and not caused by weather, the engineer will make an adjustment (excluding profit) and modify the contract in writing accordingly. The contractor will be notified of the engineer's determination whether or not an adjustment of the contract is warranted.
3. No contract adjustment will be allowed unless the contractor has submitted the request for adjustment within the time prescribed.

- 4. No contract adjustment will be allowed under this clause to the extent that performance would have been suspended or delayed by any other cause, or for which an adjustment is provided or excluded under any other term or condition of this contract.

**C. Significant Changes in the Character of Work**

- 1. The engineer reserves the right to make, in writing, at any time during the work, such changes in quantities and such alterations in the work as are necessary to satisfactorily complete the project. Such changes in quantities and alterations shall not invalidate the contract nor release the surety, and the contractor agrees to perform the work as altered.
- 2. If the alterations or changes in quantities significantly change the character of the work under the contract, whether such alterations or changes are in themselves significant changes to the character of the work or by affecting other work cause such other work to become significantly different in character, an adjustment, excluding anticipated profit, will be made to the contract. The basis for the adjustment shall be agreed upon prior to the performance of the work. If a basis cannot be agreed upon, then an adjustment will be made either for or against the contractor in such amount as the engineer may determine to be fair and equitable.
- 3. If the alterations or changes in quantities do not significantly change the character of the work to be performed under the contract, the altered work will be paid for as provided elsewhere in the contract.
- 4. The term “significant change” shall be construed to apply only to the following circumstances:
  - When the character of the work as altered differs materially in kind or nature from that involved or included in the original proposed construction; or
  - When a major item of work, as defined elsewhere in the contract, is increased in excess of 125 percent or decreased below 75 percent of the original contract quantity. Any allowance for an increase in quantity shall apply only to that portion in excess of 125 percent of original contract item quantity, or in case of a decrease below 75 percent, to the actual amount of work performed.

^^

**5 CONTROL OF WORK**

*Add to section 5-1.13A:*

The subcontractors listed on the “Subcontractor List,” shall perform the work and supply the materials for which they are listed, unless the Contractor has received prior written authorization to perform the work with other forces or to obtain the materials from other sources.

The Contractor should notify the Engineer in writing of any changes to its anticipated subcontractor participation. This notice should be provided prior to the commencement of that portion of the work.

*Add to section 5-1.36C:*

The Contractor's attention is directed to the existence of certain underground facilities that may require special precautions be taken by the Contractor to protect the health, safety and welfare of workmen and of the public. Facilities requiring special precautions include, but are not limited to: conductors of petroleum products, oxygen, chlorine, and toxic or flammable gases; natural gas in pipelines greater than 150 mm (6 inches) in diameter or pipelines operating at pressures greater than 415 kPa (60 psi) gauge; underground electric supply system conductors or cables, with potential to ground of more than 300 volts, either directly buried or in duct or conduit which do not have concentric grounded conductors or other effectively grounded metal shields or sheaths.

Per Govt Code § 4216 et seq., the Contractor shall notify the Engineer and the appropriate regional notification center for operators of subsurface installations at least 3 working days, but not more than 14 calendar days, prior to performing any excavation or other work close to any underground pipeline, conduit, duct, wire or other structure. Regional notification centers include but are not limited to the following:

Notification Center	Telephone Number
Underground Service Alert-Northern California (USA)	1-800-642-2444 1-800-227-2600
Underground Service Alert-Southern California (USA)	1-800-422-4133 1-800-227-2600

***Add between the 2nd and 3rd paragraphs of section 5-1.36C(3):***

The utility owner will relocate a utility shown in the following table before the corresponding date shown:

<b>Utility Relocation and Date of the Relocation</b>		
Utility	Location	Date
Frontier Communications Overhead Communication Line	Post Mile 21.8	Prior to Construction
Frontier Communications Guy Wire	Post Mile 21.8	Prior to Construction

^^

**6 CONTROL OF MATERIALS**

***Replace section 6-1.04 with:***

**BUY AMERICA (Required Federal Language)**

Furnish steel and iron materials to be incorporated into the work with certificates of compliance and certified mill test reports. Mill test reports must indicate where the steel and iron were melted and manufactured. Steel and iron materials must be produced in the U.S. except:

1. Foreign pig iron and processed, pelletized, and reduced iron ore may be used in the domestic production of the steel and iron materials [60 Fed Reg 15478 (03/24/1995)];

- 2. If the total combined cost of the materials does not exceed the greater of 0.1 percent of the total bid or \$2,500, materials produced outside the U.S. may be used.

Production includes:

- 1. Processing steel and iron materials, including smelting or other processes that alter the physical form or shape (such as rolling, extruding, machining, bending, grinding, and drilling) or chemical composition;
- 2. Coating application, including epoxy coating, galvanizing, and painting, that protects or enhances the value of steel and iron materials.

*Replace the 4th paragraph in section 6-2.01 with:*

**QUALITY ASSURANCE** (Required Federal Language)

The County uses a Quality Assurance Program (QAP) to ensure a material is produced to comply with the Contract.

The County may examine the records and reports of tests the prime contractor performs if they are available at the job site. Schedule work to allow time for QAP.

^^

**7 LEGAL RELATIONS AND RESPONSIBILITY TO THE PUBLIC**

*Add to section 7-1.02K:*

**7-1.02K(7) Labor Code 1725.5**

A contractor or subcontractor shall not be qualified to bid on, be listed in a bid proposal, subject to the requirements of Section 4104 of the Public Contract Code, or engage in the performance of any contract for public work, as defined in this chapter, unless currently registered and qualified to perform public work pursuant to Section 1725.5. It is not a violation of this section for an unregistered contractor to submit a bid that is authorized by Section 7029.1 of the Business and Professions Code or by Section 10164 or 20103.5 of the Public Contract Code, provided the contractor is registered to perform public work pursuant to Section 1725.5 at the time the contract is awarded.

*Replace #1 in the 2nd paragraph in section 7-1.02K(2) with:*

- #1 At the Humboldt County Department of Public Works, 1106 Second Street, Eureka CA 95501.

**FEDERAL WAGE RATES**

The predetermined federal wages are derived from the Davis-Bacon Act of 1931 and are prescribed by 23 USC 113. The Federal Wage Rates are available directly from the Department of Labor at: <https://beta.sam.gov/>. The user is given a choice between entering in the determination number example: "CA2008004" or selecting the criteria State/County/Construction Type/WD number

(WD num not needed). Select California/Humboldt/Highway, respectively. Copies of the Federal Wage Rates will also be available at:

Information Office  
County of Humboldt, Department of Public Works  
1106 Second Street  
Eureka, CA 95501

Federal Wage Rates are not required to be physically included in this Bid Package. However, the federal wage rates as revised by addendums, if such addendums are issued, are included in the Agreement signed by the County of Humboldt and the Contractor.

***Add to section 7-1.02L(1):***

**Public Contract Code, Sec. 7106 (Noncollusion)**

In conformance with Public Contract Code Section 7106, a Noncollusion Affidavit is included in the Proposal. Signing the Proposal shall also constitute signature of the Noncollusion Affidavit.

***Replace section 7-1.02M(3) with:***

Material from mining operations furnished for this project shall only come from sites in compliance with the Surface Mining and Reclamation Act of 1975 (SMARA) or sites not subject to SMARA. Contractor shall provide County with documentation establishing compliance with SMARA or exemption from SMARA.

The requirements of this section shall apply to materials furnished for the project, except for acquisition of materials in conformance with the provisions in section 4-1.04, "Use of Materials Found on the Job Site," of the Standard Specifications.

***Add to section 7-1.11A:***

**TITLE VI ASSURANCES (Required Federal Language)**

During the performance of this Agreement, the contractor, for itself, its assignees and successors in interest (hereinafter collectively referred to as CONTRACTOR) agrees as follows:

- (1) Compliance with Regulations: CONTRACTOR shall comply with the regulations relative to nondiscrimination in federally assisted programs of the Department of Transportation, Title 49, Code of Federal Regulations, Part 21, as they may be amended from time to time, (hereinafter referred to as the REGULATIONS), which are herein incorporated by reference and made a part of this agreement.
- (2) Nondiscrimination: CONTRACTOR, with regard to the work performed by it during the AGREEMENT, shall not discriminate on the grounds of race, color, sex, national origin, religion, age, or disability in the selection and retention of sub-applicants, including procurements of materials and leases of equipment. CONTRACTOR shall not participate either directly or indirectly in the discrimination prohibited by Section 21.5 of the Regulations, including employment practices when the agreement covers a program set forth in Appendix B of the Regulations.
- (3) Solicitations for Sub-agreements, Including Procurements of Materials and Equipment: In all solicitations either by competitive bidding or negotiation made by CONTRACTOR for



work to be performed under a Sub-agreement, including procurements of materials or leases of equipment, each potential sub-applicant or supplier shall be notified by CONTRACTOR of the CONTRACTOR'S obligations under this Agreement and the Regulations relative to nondiscrimination on the grounds of race, color, or national origin.

- (4) Information and Reports: CONTRACTOR shall provide all information and reports required by the Regulations, or directives issued pursuant thereto, and shall permit access to its books, records, accounts, other sources of information, and its facilities as may be determined by the California Department of Transportation or FHWA to be pertinent to ascertain compliance with such Regulations or directives. Where any information required of CONTRACTOR is in the exclusive possession of another who fails or refuses to furnish this information, CONTRACTOR shall so certify to the California Department of Transportation or the FHWA as appropriate, and shall set forth what efforts CONTRACTOR has made to obtain the information.
- (5) Sanctions for Noncompliance: In the event of CONTRACTOR's noncompliance with the nondiscrimination provisions of this agreement, the California Department of Transportation shall impose such agreement sanctions as it or the FHWA may determine to be appropriate, including, but not limited to:
- (a) withholding of payments to CONTRACTOR under the Agreement within a reasonable period of time, not to exceed 90 days; and/or
  - (b) cancellation, termination or suspension of the Agreement, in whole or in part.
- (6) Incorporation of Provisions: CONTRACTOR shall include the provisions of paragraphs (1) through (6) in every sub-agreement, including procurements of materials and leases of equipment, unless exempt by the Regulations, or directives issued pursuant thereto.

CONTRACTOR shall take such action with respect to any sub-agreement or procurement as the California Department of Transportation or FHWA may direct as a means of enforcing such provisions including sanctions for noncompliance, provided, however, that, in the event CONTRACTOR becomes involved in, or is threatened with, litigation with a sub-applicant or supplier as a result of such direction, CONTRACTOR may request the California Department of Transportation enter into such litigation to protect the interests of the State, and, in addition, CONTRACTOR may request the United States to enter into such litigation to protect the interests of the United States.

#### **Appendix E of the Title VI Assurances (US DOT Order 1050.2A)**

During the performance of this contract, the contractor, for itself, its assignees, and successors in interest (hereinafter referred to as the "contractor") agrees to comply with the following nondiscrimination statutes and authorities; including but not limited to:

#### **Pertinent Nondiscrimination Authorities:**

- Title VI of the Civil Rights Act of 1964 (42 U.S.C. § 2000d et seq., 78 stat. 252), (prohibits discrimination on the basis of race, color, national origin); and 49 CFR Part 21.

- The Uniform Relocation Assistance and Real Property Acquisition Policies Act of 1970, (42 U.S.C. § 4601), (prohibits unfair treatment of persons displaced or whose property has been acquired because of Federal or Federal-aid programs and projects);
- Federal-Aid Highway Act of 1973, (23 U.S.C. § 324 et seq.), (prohibits discrimination on the basis of sex);
- Section 504 of the Rehabilitation Act of 1973, (29 U.S.C. § 794 et seq.), as amended, (prohibits discrimination on the basis of disability); and 49 CFR Part 27;
- The Age Discrimination Act of 1975, as amended, (42 U.S.C. § 6101 et seq.), (prohibits discrimination on the basis of age);
- Airport and Airway Improvement Act of 1982, (49 U.S.C. § 4 71, Section 47123), as amended, (prohibits discrimination based on race, creed, color, national origin, or sex);
- The Civil Rights Restoration Act of 1987, (PL 100-209), (Broadened the scope, coverage and applicability of Title VI of the Civil Rights Act of 1964, The Age Discrimination Act of 1975 and Section 504 of the Rehabilitation Act of 1973, by expanding the definition of the terms “programs or activities” to include all of the programs or activities of the Federal-aid recipients, subrecipients and contractors, whether such programs or activities are Federally funded or not);
- Titles II and III of the Americans with Disabilities Act, which prohibit discrimination on the basis of disability in the operation of public entities, public and private transportation systems, places of public accommodation, and certain testing entities (42 U.S.C. §§ 12131-12189) as implemented by Department of Transportation regulations at 49 C.F.R. parts 37 and 38;The Federal Aviation Administration's Nondiscrimination statute (49 U.S.C. § 47123) (prohibits discrimination on the basis of race, color, national origin, and sex);
- Executive Order 12898, Federal Actions to Address Environmental Justice in Minority Populations and Low-Income Populations, which ensures discrimination against minority populations by discouraging programs, policies, and activities with disproportionately high and adverse human health or environmental effects on minority and low-income populations;
- Executive Order 13166, Improving Access to Services for Persons with Limited English Proficiency, and resulting agency guidance, national origin discrimination includes discrimination because of limited English proficiency (LEP). To ensure compliance with Title VI, you must take reasonable steps to ensure that LEP persons have meaningful access to your programs (70 Fed. Reg. at 74087 to 74100);
- Title IX of the Education Amendments of 1972, as amended, which prohibits you from discriminating because of sex in education programs or activities (20 U.S.C. 1681 et seq)

***Add to section 7-1.11A:***

Federal lobbying restrictions imposed by Section 1352, Title 31, United States Code, is included in section 7-1.11B(XI).

A certification for Federal-aid contracts regarding payment of funds to lobby Congress or a Federal agency is included in the Proposal. Standard Form - LLL, "Disclosure of Lobbying Activities," with instructions for completion of the Standard Form is also included in the Proposal. Signing the Proposal shall constitute signature of the Certification.

The Contractor, subcontractors and any lower-tier contractors shall file a disclosure form at the end of each calendar quarter in which there occurs any event that requires disclosure or that materially affects the accuracy of the information contained in any disclosure form previously filed by the Contractor, subcontractors and any lower-tier contractors. An event that materially affects the accuracy of the information reported includes:

1. A cumulative increase of \$25,000 or more in the amount paid or expected to be paid for influencing or attempting to influence a covered Federal action; or
2. A change in the person(s) or individual(s) influencing or attempting to influence a covered Federal action; or
3. A change in the officer(s), employee(s), or Member(s) contacted to influence or attempt to influence a covered Federal Action.

***Add to section 7-1.11A:***

**USE OF UNITED STATES-FLAG VESSELS (CARGO PREFERENCE ACT)**

(Required Federal Language)

The contractor agrees –

1. To utilize privately owned United State flag commercial vessels to ship at least 50 percent of the gross tonnage (computed separately for dry bulk carriers, dry cargo liners, and tankers) involved, whenever shipping any equipment, material, or commodities pursuant to this contract, to the extent such vessels are available at fair and reasonable rates for United States-flag commercial vessels.
2. To furnish within 20 days following the date of loading for shipments originating within the United States or within 30 working days following the date, of loading for shipments originating outside the United States, a legible copy of a rated, 'on-board' commercial ocean bill-of-lading in English for each shipment of cargo described in paragraph (1) of this section to both the Contracting Officer (through the prime contractor in the case of subcontractor bills-of lading) and to the Division of National Cargo, Office of Market Development, Maritime Administration, Washington, DC 20590.
3. To insert the substance of the provisions of this clause in all subcontracts issued pursuant to this contract.

**Replace section 7-1.11B with:****CONTRACT PROVISIONS FEDERAL-AID CONSTRUCTION CONTRACTS**  
(Required Federal Language)

FHWA-1273 -- Revised May 1, 2012

- I. General
- II. Nondiscrimination
- III. Nonsegregated Facilities
- IV. Davis-Bacon and Related Act Provisions
- V. Contract Work Hours and Safety Standards Act Provisions
- VI. Subletting or Assigning the Contract
- VII. Safety: Accident Prevention
- VIII. False Statements Concerning Highway Projects
- IX. Implementation of Clean Air Act and Federal Water Pollution Control Act
- X. Compliance with Government wide Suspension and Debarment Requirements
- XI. Certification Regarding Use of Contract Funds for Lobbying

**ATTACHMENTS**

A. Employment and Materials Preference for Appalachian Development Highway System or Appalachian Local Access Road Contracts (included in Appalachian contracts only)

**I. GENERAL**

1. Form FHWA-1273 must be physically incorporated in each construction contract funded under Title 23 (excluding emergency contracts solely intended for debris removal). The contractor (or subcontractor) must insert this form in each subcontract and further require its inclusion in all lower tier subcontracts (excluding purchase orders, rental agreements and other agreements for supplies or services).

The applicable requirements of Form FHWA-1273 are incorporated by reference for work done under any purchase order, rental agreement or agreement for other services. The prime contractor shall be responsible for compliance by any subcontractor, lower-tier subcontractor or service provider.

Form FHWA-1273 must be included in all Federal-aid design-build contracts, in all subcontracts and in lower tier subcontracts (excluding subcontracts for design services, purchase orders, rental agreements and other agreements for supplies or services). The design-builder shall be responsible for compliance by any subcontractor, lower-tier subcontractor or service provider.

Contracting agencies may reference Form FHWA-1273 in bid proposal or request for proposal documents, however, the Form FHWA-1273 must be physically incorporated (not referenced) in all contracts, subcontracts and lower-tier subcontracts (excluding purchase orders, rental agreements

and other agreements for supplies or services related to a construction contract).

2. Subject to the applicability criteria noted in the following sections, these contract provisions shall apply to all work performed on the contract by the contractor's own organization and with the assistance of workers under the contractor's immediate superintendence and to all work performed on the contract by piecework, station work, or by subcontract.

3 A breach of any of the stipulations contained in these Required Contract Provisions may be sufficient grounds for withholding of progress payments, withholding of final payment, termination of the contract, suspension / debarment or any other action determined to be appropriate by the contracting agency and FHWA

4 Selection of Labor During the performance of this contract, the contractor shall not use convict labor for any purpose within the limits of a construction project on a Federal-aid highway unless it is labor performed by convicts who are on parole, supervised release, or probation The term Federal-aid highway does not include roadways functionally classified as local roads or rural minor collectors

**II. NONDISCRIMINATION**

The provisions of this section related to 23 CFR Part 230 are applicable to all Federal-aid construction contracts and to all related construction subcontracts of \$10,000 or more The provisions of 23 CFR Part 230 are not applicable to material supply, engineering, or architectural service contracts

In addition, the contractor and all subcontractors must comply with the following policies Executive Order 11 246, 41 CFR 60, 29 CFR 1625-1627, Title 23 USC Section 140, the Rehabilitation Act of 1 973, as amended (29 USC 794), Title VI of the Civil Rights Act of 1964, as amended, and related regulations including 49 CFR Parts 21, 26 and 27, and 23 CFR Parts 200, 230, and 633

The contractor and all subcontractors must comply with: the requirements of the Equal Opportunity Clause in 41 CFR 60-1.4(b) and, for all construction contracts exceeding \$10,000, the Standard Federal Equal Employment Opportunity Construction Contract Specifications in 41 CFR 60-4.3.

Note The U S Department of Labor has exclusive authority to determine compliance with Executive Order 11246 and the policies of the Secretary of Labor including 41 CFR 60, and 29 CFR 1625-1627 The contracting agency and the FHWA have the authority and the responsibility to ensure compliance with

Title 23 USC Section 140, the Rehabilitation Act of 1973, as amended (29 USC 794), and Title VI of the Civil Rights Act of 1964, as amended, and related regulations including 49 CFR Parts 21, 26 and 27, and 23 CFR Parts 200, 230, and 633. The following provision is adopted from 23 CFR 230, Appendix A, with appropriate revisions to conform to the U S Department of Labor (US DOL) and FHWA requirements.

**1. Equal Employment Opportunity:** Equal employment

opportunity (EEO) requirements not to discriminate and to take affirmative action to assure equal opportunity as set forth under laws, executive orders, rules, regulations (28 CFR 35, 29 CFR 1630, 29 CFR 1625-1627, 41 CFR 60 and 49 CFR 27) and orders of the Secretary of Labor as modified by the provisions prescribed herein, and imposed pursuant to 23 U.S.C. 140 shall constitute the EEO and specific affirmative action standards for the contractor's project activities under this contract. The provisions of the Americans with Disabilities Act of 1990 (42 U.S.C. 12101 et seq.) set forth under 28 CFR 35 and 29 CFR 1630 are incorporated by reference in this contract. In the execution of this contract, the contractor agrees to comply with the following minimum specific requirement activities of EEO:

a. The contractor will work with the contracting agency and the Federal Government to ensure that it has made every good faith effort to provide equal opportunity with respect to all of its terms and conditions of employment and in their review of activities under the contract.

b. The contractor will accept as its operating policy the following statement:

"It is the policy of this Company to assure that applicants are employed, and that employees are treated during employment, without regard to their race, religion, sex, color, national origin, age or disability. Such action shall include: employment, upgrading, demotion, or transfer; recruitment or recruitment advertising; layoff or termination; rates of pay or other forms of compensation; and selection for training, including apprenticeship, pre-apprenticeship, and/or on-the-job training.

**2. EEO Officer:** The contractor will designate and make known to the contracting officers an EEO Officer who will have the responsibility for and must be capable of effectively administering and promoting an active EEO program and who must be assigned adequate authority and responsibility to do so.

**3. Dissemination of Policy:** All members of the contractor's staff who are authorized to hire, supervise, promote, and discharge employees, or who recommend such action, or who are substantially involved in such action, will be made fully cognizant of, and will implement, the contractor's EEO policy and contractual responsibilities to provide EEO in each grade and classification of employment. To ensure that the above agreement will be met, the following actions will be taken as a minimum:

a. Periodic meetings of supervisory and personnel office employees will be conducted before the start of work and then not less often than once every six months, at which time the contractor's EEO policy and its implementation will be reviewed and explained. The meetings will be conducted by the EEO Officer.

b. All new supervisory or personnel office employees will be given a thorough indoctrination by the EEO Officer, covering all major aspects of the contractor's EEO obligations within thirty days following their reporting for duty with the contractor.

c. All personnel who are engaged in direct recruitment for the project will be instructed by the EEO Officer in the contractor's procedures for locating and hiring minorities and women.

d. Notices and posters setting forth the contractor's EEO policy will be placed in areas readily accessible to employees, applicants for employment and potential employees.

e. The contractor's EEO policy and the procedures to implement such policy will be brought to the attention of employees by means of meetings, employee handbooks, or other appropriate means.

**4. Recruitment:** When advertising for employees, the contractor will include in all advertisements for employees the notation: "An Equal Opportunity Employer." All such advertisements will be placed in publications having a large circulation among minorities and women in the area from which the project work force would normally be derived.

a. The contractor will, unless precluded by a valid bargaining agreement, conduct systematic and direct recruitment through public and private employee referral sources likely to yield qualified minorities and women. To meet this requirement, the contractor will identify sources of potential minority group employees, and establish with such identified sources procedures whereby minority and women applicants may be referred to the contractor for employment consideration.

b. In the event the contractor has a valid bargaining agreement providing for exclusive hiring hall referrals, the contractor is expected to observe the provisions of that agreement to the extent that the system meets the contractor's compliance with EEO contract provisions. Where implementation of such an agreement has the effect of discriminating against minorities or women, or obligates the contractor to do the same, such implementation violates Federal nondiscrimination provisions.

c. The contractor will encourage its present employees to refer minorities and women as applicants for employment. Information and procedures with regard to referring such applicants will be discussed with employees.

**5. Personnel Actions:** Wages, working conditions, and employee benefits shall be established and administered, and personnel actions of every type, including hiring, upgrading, promotion, transfer, demotion, layoff, and termination, shall be taken without regard to race, color, religion, sex, national origin, age or disability. The following procedures shall be followed:

a. The contractor will conduct periodic inspections of project sites to insure that working conditions and employee facilities do not indicate discriminatory treatment of project site personnel.

b. The contractor will periodically evaluate the spread of wages paid within each classification to determine any evidence of discriminatory wage practices.

c. The contractor will periodically review selected personnel actions in depth to determine whether there is evidence of discrimination. Where evidence is found, the contractor will promptly take corrective action. If the review indicates that the discrimination may

extend beyond the actions reviewed, such corrective action shall include all affected persons.

d. The contractor will promptly investigate all complaints of alleged discrimination made to the contractor in connection with its obligations under this contract, will attempt to resolve such complaints, and will take appropriate corrective action within a reasonable time. If the investigation indicates that the discrimination may affect persons other than the complainant, such corrective action shall include such other persons. Upon completion of each investigation, the contractor will inform every complainant of all of their avenues of appeal.

## 6. Training and Promotion:

a. The contractor will assist in locating, qualifying, and increasing the skills of minorities and women who are should be aimed at developing full journey level status employees in the type of trade or job classification involved.

b. Consistent with the contractor's work force requirements and as permissible under Federal and State regulations, the contractor shall make full use of training programs, i.e., apprenticeship, and on-the-job training programs for the geographical area of contract performance. In the event a special provision for training is provided under this contract, this subparagraph will be superseded as indicated in the special provision. The contracting agency may reserve training positions for persons who receive welfare assistance in accordance with 23 U.S.C. 140(a).

c. The contractor will advise employees and applicants for employment of available training programs and entrance requirements for each.

d. The contractor will periodically review the training and promotion potential of employees who are minorities and women and will encourage eligible employees to apply for such training and promotion.

**7. Unions:** If the contractor relies in whole or in part upon unions as a source of employees, the contractor will use good faith efforts to obtain the cooperation of such unions to increase opportunities for minorities and women. Actions by the contractor, either directly or through a contractor's association acting as agent, will include the procedures set forth below:

a. The contractor will use good faith efforts to develop, in cooperation with the unions, joint training programs aimed toward qualifying more minorities and women for membership in the unions and increasing the skills of minorities and women so that they may qualify for higher paying employment.

b. The contractor will use good faith efforts to incorporate an EEO clause into each union agreement to the end that such union will be contractually bound to refer applicants without regard to their race, color, religion, sex, national origin, age or disability.

c. The contractor is to obtain information as to the referral practices and policies of the labor union except that to the extent such information is within the exclusive possession of the labor union and such labor union refuses to furnish such information to the contractor, the contractor shall so certify to the contracting agency and shall set forth what efforts have been made to obtain such information.

d. In the event the union is unable to provide the contractor with a reasonable flow of referrals within the time limit set forth in the collective bargaining agreement, the contractor will, through independent recruitment efforts, fill the employment vacancies without regard to race, color, religion, sex, national origin, age or disability; making full efforts to obtain qualified and/or qualifiable minorities and women. The failure of a union to provide sufficient referrals (even though it is obligated to provide exclusive referrals under the terms of a collective bargaining agreement) does not relieve the contractor from the requirements of this paragraph. In the event the union referral practice prevents the contractor from meeting the obligations pursuant to Executive Order 11246, as amended, and these special provisions, such contractor shall immediately notify the contracting agency.

## 8. Reasonable Accommodation for Applicants / Employees with Disabilities:

The contractor must be familiar with the requirements for and comply with the Americans with Disabilities Act and all rules and regulations established there under. Employers must provide reasonable accommodation in all employment activities unless to do so would cause an undue hardship.

## 9. Selection of Subcontractors, Procurement of Materials and Leasing of Equipment:

The contractor shall not discriminate on the grounds of race, color, religion, sex, national origin, age or disability in the selection and retention of subcontractors, including procurement of materials and leases of equipment. The contractor shall take all necessary and reasonable steps to ensure nondiscrimination in the administration of this contract.

a. The contractor shall notify all potential subcontractors and suppliers and lessors of their EEO obligations under this contract.

b. The contractor will use good faith efforts to ensure subcontractor compliance with their EEO obligations.

## 10. Assurance Required by 49 CFR 26.13(b):

a. The requirements of 49 CFR Part 26 and the State DOT's U.S. DOT-approved DBE program are incorporated by reference.

b. The contractor or subcontractor shall not discriminate on the basis of race, color, national origin, or sex in the performance of this contract. The contractor shall carry out applicable requirements of 49 CFR Part 26 in the award and administration of DOT-assisted contracts. Failure by the contractor to carry out these requirements is a material breach of this contract, which may result in the termination of this contract or such other remedy as the contracting agency deems appropriate.

**11. Records and Reports:** The contractor shall keep such records as necessary to document compliance with the EEO requirements. Such records shall be retained for a period of three years following the date of the final payment to the contractor for all contract work and shall be available at reasonable times and places for inspection by authorized representatives of the contracting agency and the FHWA.

a. The records kept by the contractor shall document the following:

(1) The number and work hours of minority and non-minority group members and women employed in each work classification on the project;

(2) The progress and efforts being made in cooperation with unions, when applicable, to increase employment opportunities for minorities and women; and

(3) The progress and efforts being made in locating, hiring, training, qualifying, and upgrading minorities and women;

b. The contractors and subcontractors will submit an annual report to the contracting agency each July for the duration of the project, indicating the number of minority, women, and non-minority group employees currently engaged in each work classification required by the contract work. This information is to be reported on Form FHWA-1391. The staffing data should represent the project work force on board in all or any part of the last payroll period preceding the end of July. If on-the-job training is being required by special provision, the contractor will be required to collect and report training data. The employment data should reflect the work force on board during all or any part of the last payroll period preceding the end of July.

### III. NONSEGREGATED FACILITIES

This provision is applicable to all Federal-aid construction contracts and to all related construction subcontracts of \$10,000 or more.

The contractor must ensure that facilities provided for employees are provided in such a manner that segregation on the basis of race, color, religion, sex, or national origin cannot result. The contractor may neither require such segregated use by written or oral policies nor tolerate such use by employee custom. The contractor's obligation extends further to ensure that its employees are not assigned to perform their services at any location, under the contractor's control, where the facilities are segregated. The term "facilities" includes waiting rooms, work areas, restaurants and other eating areas, time clocks, restrooms, washrooms, locker rooms, and other storage or dressing areas, parking lots, drinking fountains, recreation or entertainment areas, transportation, and housing provided for employees. The contractor shall provide separate or single-user restrooms and necessary dressing or sleeping areas to assure privacy between sexes.

### IV. DAVIS-BACON AND RELATED ACT PROVISIONS

This section is applicable to all Federal-aid construction projects exceeding \$2,000 and to all related subcontracts and lower-tier subcontracts (regardless of subcontract size). The requirements apply to all projects located within the right-of-way of a roadway that is functionally classified as Federal-aid highway. This excludes roadways functionally classified as local roads or rural minor collectors, which are exempt. Contracting agencies may elect to apply these requirements to other projects.

The following provisions are from the U.S. Department of Labor regulations in 29 CFR 5.5 "Contract provisions and related matters" with minor revisions to conform to the FHWA-1273 format and FHWA program requirements.

#### 1. Minimum wages

a. All laborers and mechanics employed or working upon the site of the work, will be paid unconditionally and not less often than once a week, and without subsequent deduction or rebate on any account

(except such payroll deductions as are permitted by regulations issued by the Secretary of Labor under the Copeland Act (29 CFR part 3)), the full amount of wages and bona fide fringe benefits (or cash equivalents thereof) due at time of payment computed at rates not less than those contained in the wage determination of the Secretary of Labor which is attached hereto and made a part hereof, regardless of any contractual relationship which may be alleged to exist between the contractor and such laborers and mechanics.

Contributions made or costs reasonably anticipated for bona fide fringe benefits under section 1(b)(2) of the Davis-Bacon Act on behalf of laborers or mechanics are considered wages paid to such laborers or mechanics, subject to the provisions of paragraph 1.d. of this section; also, regular contributions made or costs incurred for more than a weekly period (but not less often than quarterly) under plans, funds, or programs which cover the particular weekly period, are deemed to be constructively made or incurred during such weekly period. Such laborers and mechanics shall be paid the appropriate wage rate and fringe benefits on the wage determination for the classification of work actually performed, without regard to skill, except as provided in 29 CFR 5.5(a)(4). Laborers or mechanics performing work in more than one classification may be compensated at the rate specified for each classification for the time actually worked therein: Provided, That the employer's payroll records accurately set forth the time spent in each classification in which work is performed. The wage determination (including any additional classification and wage rates conformed under paragraph 1.b. of this section) and the Davis-Bacon poster (WH-1321) shall be posted at all times by the contractor and its subcontractors at the site of the work in a prominent and accessible place where it can be easily seen by the workers.

b.(1) The contracting officer shall require that any class of laborers or mechanics, including helpers, which is not listed in the wage determination and which is to be employed under the contract shall be classified in conformance with the wage determination. The contracting officer shall approve an additional classification and wage rate and fringe benefits therefore only when the following criteria have been met:

(i) The work to be performed by the classification requested is not performed by a classification in the wage determination; and

(ii) The classification is utilized in the area by the construction industry; and

(iii) The proposed wage rate, including any bona fide fringe benefits, bears a reasonable relationship to the wage rates contained in the wage determination.

(2) If the contractor and the laborers and mechanics to be employed in the classification (if known), or their representatives, and the contracting officer agree on the classification and wage rate (including the amount designated for fringe benefits where appropriate), a report of the action taken shall be sent by the contracting officer to the Administrator of the Wage and Hour Division, Employment Standards Administration, U.S. Department of Labor, Washington, DC 20210. The Administrator, or an authorized representative, will approve, modify, or disapprove every additional classification action within 30 days of receipt and so advise the contracting officer or will notify the contracting officer within the 30-day period that additional time is necessary.

(3) In the event the contractor, the laborers or mechanics to be employed in the classification or their representatives, and the contracting officer do not agree on the proposed classification and

wage rate (including the amount designated for fringe benefits, where appropriate), the contracting officer shall refer the questions, including the views of all interested parties and the recommendation of the contracting officer, to the Wage and Hour Administrator for determination. The Wage and Hour Administrator, or an authorized representative, will issue a determination within 30 days of receipt and so advise the contracting officer or will notify the contracting officer within the 30-day period that additional time is necessary.

(4) The wage rate (including fringe benefits where appropriate) determined pursuant to paragraphs 1.b.(2) or 1.b.(3) of this section, shall be paid to all workers performing work in the classification under this contract from the first day on which work is performed in the classification.

c. Whenever the minimum wage rate prescribed in the contract for a class of laborers or mechanics includes a fringe benefit which is not expressed as an hourly rate, the contractor shall either pay the benefit as stated in the wage determination or shall pay another bona fide fringe benefit or an hourly cash equivalent thereof.

d. If the contractor does not make payments to a trustee or other third person, the contractor may consider as part of the wages of any laborer or mechanic the amount of any costs reasonably anticipated in providing bona fide fringe benefits under a plan or program, Provided, That the Secretary of Labor has found, upon the written request of the contractor, that the applicable standards of the Davis-Bacon Act have been met. The Secretary of Labor may require the contractor to set aside in a separate account assets for the meeting of obligations under the plan or program.

## 2. Withholding

The contracting agency shall upon its own action or upon written request of an authorized representative of the Department of Labor, withhold or cause to be withheld from the contractor under this contract, or any other Federal contract with the same prime contractor, or any other federally-assisted contract subject to Davis-Bacon prevailing wage requirements, which is held by the same prime contractor, so much of the accrued payments or advances as may be considered necessary to pay laborers and mechanics, including apprentices, trainees, and helpers, employed by the contractor or any subcontractor the full amount of wages required by the contract. In the event of failure to pay any laborer or mechanic, including any apprentice, trainee, or helper, employed or working on the site of the work, all or part of the wages required by the contract, the contracting agency may, after written notice to the contractor, take such action as may be necessary to cause the suspension of any further payment, advance, or guarantee of funds until such violations have ceased.

## 3. Payrolls and basic records

a. Payrolls and basic records relating thereto shall be maintained by the contractor during the course of the work and preserved for a period of three years thereafter for all laborers and mechanics working at the site of the work. Such records shall contain the name, address, and social security number of each such worker, his or her correct classification, hourly rates of wages paid (including rates of contributions or costs anticipated for bona fide fringe benefits or cash equivalents thereof of the types described in section 1(b)(2)(B) of the Davis-Bacon Act), daily and weekly number of hours worked, deductions made and actual wages paid. Whenever the Secretary of Labor has found under 29 CFR 5.5(a)(1)(iv) that the wages of any laborer or mechanic include the amount of any costs reasonably anticipated in providing benefits under a plan or

program described in section 1(b)(2)(B) of the Davis-Bacon Act, the contractor shall maintain records which show that the commitment to provide such benefits is enforceable, that the plan or program is financially responsible, and that the plan or program has been communicated in writing to the laborers or mechanics affected, and records which show the costs anticipated or the actual cost incurred in providing such benefits. Contractors employing apprentices or trainees under approved programs shall maintain written evidence of the registration of apprenticeship programs and certification of trainee programs, the registration of the apprentices and trainees, and the ratios and wage rates prescribed in the applicable programs.

b.(1) The contractor shall submit weekly for each week in which any contract work is performed a copy of all payrolls to the contracting agency. The payrolls submitted shall set out accurately and completely all of the information required to be maintained under 29 CFR 5.5(a)(3)(i), except that full social security numbers and home addresses shall not be included on weekly transmittals. Instead the payrolls shall only need to include an individually identifying number for each employee (e.g., the last four digits of the employee's social security number). The required weekly payroll information may be submitted in any form desired. Optional Form WH-347 is available for this purpose from the Wage and Hour Division Web site at <http://www.dol.gov/esa/whd/forms/wh347instr.htm> or its successor site. The prime contractor is responsible for the submission of copies of payrolls by all subcontractors. Contractors and subcontractors shall maintain the full social security number and current address of each covered worker, and shall provide them upon request to the contracting agency for transmission to the State DOT, the FHWA or the Wage and Hour Division of the Department of Labor for purposes of an investigation or audit of compliance with prevailing wage requirements. It is not a violation of this section for a prime contractor to require a subcontractor to provide addresses and social security numbers to the prime contractor for its own records, without weekly submission to the contracting agency..

(2) Each payroll submitted shall be accompanied by a "Statement of Compliance," signed by the contractor or subcontractor or his or her agent who pays or supervises the payment of the persons employed under the contract and shall certify the following:

(i) That the payroll for the payroll period contains the information required to be provided under §5.5 (a)(3)(ii) of Regulations, 29 CFR part 5, the appropriate information is being maintained under §5.5 (a)(3)(i) of Regulations, 29 CFR part 5, and that such information is correct and complete;

(ii) That each laborer or mechanic (including each helper, apprentice, and trainee) employed on the contract during the payroll period has been paid the full weekly wages earned, without rebate, either directly or indirectly, and that no deductions have been made either directly or indirectly from the full wages earned, other than permissible deductions as set forth in Regulations, 29 CFR part 3;

(iii) That each laborer or mechanic has been paid not less than the applicable wage rates and fringe benefits or cash equivalents for the classification of work performed, as specified in the applicable wage determination incorporated into the contract.

(3) The weekly submission of a properly executed certification set forth on the reverse side of Optional Form WH-347 shall satisfy the requirement for submission of the "Statement of Compliance" required by paragraph 3.b.(2) of this section.



(4) The falsification of any of the above certifications may subject the contractor or subcontractor to civil or criminal prosecution under section 1001 of title 18 and section 231 of title 31 of the United States Code.

c. The contractor or subcontractor shall make the records required under paragraph 3.a. of this section available for inspection, copying, or transcription by authorized representatives of the contracting agency, the State DOT, the FHWA, or the Department of Labor, and shall permit such representatives to interview employees during working hours on the job. If the contractor or subcontractor fails to submit the required records or to make them available, the FHWA may, after written notice to the contractor, the contracting agency or the State DOT, take such action as may be necessary to cause the suspension of any further payment, advance, or guarantee of funds. Furthermore, failure to submit the required records upon request or to make such records available may be grounds for debarment action pursuant to 29 CFR 5.12.

#### 4. Apprentices and trainees

##### a. Apprentices (programs of the USDOL).

Apprentices will be permitted to work at less than the predetermined rate for the work they performed when they are employed pursuant to and individually registered in a bona fide apprenticeship program registered with the U.S. Department of Labor, Employment and Training Administration, Office of Apprenticeship Training, Employer and Labor Services, or with a State Apprenticeship Agency recognized by the Office, or if a person is employed in his or her first 90 days of probationary employment as an apprentice in such an apprenticeship program, who is not individually registered in the program, but who has been certified by the Office of Apprenticeship Training, Employer and Labor Services or a State Apprenticeship Agency (where appropriate) to be eligible for probationary employment as an apprentice.

The allowable ratio of apprentices to journeymen on the job site in any craft classification shall not be greater than the ratio permitted to the contractor as to the entire work force under the registered program. Any worker listed on a payroll at an apprentice wage rate, who is not registered or otherwise employed as stated above, shall be paid not less than the applicable wage rate on the wage determination for the classification of work actually performed. In addition, any apprentice performing work on the job site in excess of the ratio permitted under the registered program shall be paid not less than the applicable wage rate on the wage determination for the work actually performed. Where a contractor is performing construction on a project in a locality other than that in which its program is registered, the ratios and wage rates (expressed in percentages of the journeyman's hourly rate) specified in the contractor's or subcontractor's registered program shall be observed.

Every apprentice must be paid at not less than the rate specified in the registered program for the apprentice's level of progress, expressed as a percentage of the journeymen hourly rate specified in the applicable wage determination. Apprentices shall be paid fringe benefits in accordance with the provisions of the apprenticeship program. If the apprenticeship program does not specify fringe benefits, apprentices must be paid the full amount of fringe benefits listed on the wage determination for the applicable classification. If the Administrator determines that a different

practice prevails for the applicable apprentice classification, fringes shall be paid in accordance with that determination.

In the event the Office of Apprenticeship Training, Employer and Labor Services, or a State Apprenticeship Agency recognized by the Office, withdraws approval of an apprenticeship program, the contractor will no longer be permitted to utilize apprentices at less than the applicable predetermined rate for the work performed until an acceptable program is approved.

##### b. Trainees (programs of the USDOL).

Except as provided in 29 CFR 5.16, trainees will not be permitted to work at less than the predetermined rate for the work performed unless they are employed pursuant to and individually registered in a program which has received prior approval, evidenced by formal certification by the U.S. Department of Labor, Employment and Training Administration.

The ratio of trainees to journeymen on the job site shall not be greater than permitted under the plan approved by the Employment and Training Administration.

Every trainee must be paid at not less than the rate specified in the approved program for the trainee's level of progress, expressed as a percentage of the journeyman hourly rate specified in the applicable wage determination. Trainees shall be paid fringe benefits in accordance with the provisions of the trainee program. If the trainee program does not mention fringe benefits, trainees shall be paid the full amount of fringe benefits listed on the wage determination unless the Administrator of the Wage and Hour Division determines that there is an apprenticeship program associated with the corresponding journeyman wage rate on the wage determination which provides for less than full fringe benefits for apprentices. Any employee listed on the payroll at a trainee rate who is not registered and participating in a training plan approved by the Employment and Training Administration shall be paid not less than the applicable wage rate on the wage determination for the classification of work actually performed. In addition, any trainee performing work on the job site in excess of the ratio permitted under the registered program shall be paid not less than the applicable wage rate on the wage determination for the work actually performed.

In the event the Employment and Training Administration withdraws approval of a training program, the contractor will no longer be permitted to utilize trainees at less than the applicable predetermined rate for the work performed until an acceptable program is approved.

c. Equal employment opportunity. The utilization of apprentices, trainees and journeymen under this part shall be in conformity with the equal employment opportunity requirements of Executive Order 11246, as amended, and 29 CFR part 30.

##### d. Apprentices and Trainees (programs of the U.S. DOT).

Apprentices and trainees working under apprenticeship and skill training programs which have been certified by the Secretary of Transportation as promoting EEO in connection with Federal-aid highway construction programs are not subject to the requirements of paragraph 4 of this Section IV. The straight time hourly wage rates for apprentices and trainees under such programs will be established by the particular programs. The ratio of apprentices and trainees to journeymen shall not be greater than permitted by the terms of the particular program.

**5. Compliance with Copeland Act requirements.** The contractor shall comply with the requirements of 29 CFR part 3, which are incorporated by reference in this contract.

**6. Subcontracts.** The contractor or subcontractor shall insert Form FHWA-1273 in any subcontracts and also require the subcontractors to include Form FHWA-1273 in any lower tier subcontracts. The prime contractor shall be responsible for the compliance by any subcontractor or lower tier subcontractor with all the contract clauses in 29 CFR 5.5.

**7. Contract termination:** debarment. A breach of the contract clauses in 29 CFR 5.5 may be grounds for termination of the contract, and for debarment as a contractor and a subcontractor as provided in 29 CFR 5.12.

**8. Compliance with Davis-Bacon and Related Act requirements.** All rulings and interpretations of the Davis-Bacon and Related Acts contained in 29 CFR parts 1, 3, and 5 are herein incorporated by reference in this contract.

**9. Disputes concerning labor standards.** Disputes arising out of the labor standards provisions of this contract shall not be subject to the general disputes clause of this contract. Such disputes shall be resolved in accordance with the procedures of the Department of Labor set forth in 29 CFR parts 5, 6, and 7. Disputes within the meaning of this clause include disputes between the contractor (or any of its subcontractors) and the contracting agency, the U.S. Department of Labor, or the employees or their representatives.

## **10. Certification of eligibility.**

a. By entering into this contract, the contractor certifies that neither it (nor he or she) nor any person or firm who has an interest in the contractor's firm is a person or firm ineligible to be awarded Government contracts by virtue of section 3(a) of the Davis-Bacon Act or 29 CFR 5.12(a)(1).

b. No part of this contract shall be subcontracted to any person or firm ineligible for award of a Government contract by virtue of section 3(a) of the Davis-Bacon Act or 29 CFR 5.12(a)(1).

c. The penalty for making false statements is prescribed in the U.S. Criminal Code, 18 U.S.C. 1001.

## **V. CONTRACT WORK HOURS AND SAFETY STANDARDS ACT**

The following clauses apply to any Federal-aid construction contract in an amount in excess of \$100,000 and subject to the overtime provisions of the Contract Work Hours and Safety Standards Act. These clauses shall be inserted in addition to the clauses required by 29 CFR 5.5(a) or 29 CFR 4.6. As used in this paragraph, the terms laborers and mechanics include watchmen and guards.

**1. Overtime requirements.** No contractor or subcontractor contracting for any part of the contract work which may require or involve the employment of laborers or mechanics shall require or permit any such laborer or mechanic in any

workweek in which he or she is employed on such work to work in excess of forty hours in such workweek unless such laborer or mechanic receives compensation at a rate not less than one and one-half times the basic rate of pay for all hours worked in excess of forty hours in such workweek.

**2. Violation; liability for unpaid wages; liquidated damages.** In the event of any violation of the clause set forth in paragraph (1.) of this section, the contractor and any subcontractor responsible therefor shall be liable for the unpaid wages. In addition, such contractor and subcontractor shall be liable to the United States (in the case of work done under contract for the District of Columbia or a territory, to such District or to such territory), for liquidated damages. Such liquidated damages shall be computed with respect to each individual laborer or mechanic, including watchmen and guards, employed in violation of the clause set forth in paragraph (1.) of this section, in the sum of \$10 for each calendar day on which such individual was required or permitted to work in excess of the standard workweek of forty hours without payment of the overtime wages required by the clause set forth in paragraph (1.) of this section.

**3. Withholding for unpaid wages and liquidated damages.** The FHWA or the contracting agency shall upon its own action or upon written request of an authorized representative of the Department of Labor withhold or cause to be withheld, from any moneys payable on account of work performed by the contractor or subcontractor under any such contract or any other Federal contract with the same prime contractor, or any other federally-assisted contract subject to the Contract Work Hours and Safety Standards Act, which is held by the same prime contractor, such sums as may be determined to be necessary to satisfy any liabilities of such contractor or subcontractor for unpaid wages and liquidated damages as provided in the clause set forth in paragraph (2.) of this section.

**4. Subcontracts.** The contractor or subcontractor shall insert in any subcontracts the clauses set forth in paragraph (1.) through (4.) of this section and also a clause requiring the subcontractors to include these clauses in any lower tier subcontracts. The prime contractor shall be responsible for compliance by any subcontractor or lower tier subcontractor with the clauses set forth in paragraphs (1.) through (4.) of this section.

## **VI. SUBLETTING OR ASSIGNING THE CONTRACT**

This provision is applicable to all Federal-aid construction contracts on the National Highway System.

1. The contractor shall perform with its own organization contract work amounting to not less than 30 percent (or a greater percentage if specified elsewhere in the contract) of the total original contract price, excluding any specialty items designated by the contracting agency. Specialty items may be performed by subcontract and the amount of any such specialty items performed may be deducted from the total original contract price before computing the amount of work required to be performed by the contractor's own organization (23 CFR 635.116).

a. The term "perform work with its own organization" refers to workers employed or leased by the prime contractor, and equipment owned or rented by the prime contractor, with or without operators. Such term does not include employees or equipment of a

subcontractor or lower tier subcontractor, agents of the prime contractor, or any other assignees. The term may include payments for the costs of hiring leased employees from an employee leasing firm meeting all relevant Federal and State regulatory requirements. Leased employees may only be included in this term if the prime contractor meets all of the following conditions:

- (1) The prime contractor maintains control over the supervision of the day-to-day activities of the leased employees;
- (2) The prime contractor remains responsible for the quality of the work of the leased employees;
- (3) The prime contractor retains all power to accept or exclude individual employees from work on the project; and
- (4) The prime contractor remains ultimately responsible for the payment of predetermined minimum wages, the submission of payrolls, statements of compliance and all other Federal regulatory requirements.

b. "Specialty Items" shall be construed to be limited to work that requires highly specialized knowledge, abilities, or equipment not ordinarily available in the type of contracting organizations qualified and expected to bid or propose on the contract as a whole and in general are to be limited to minor components of the overall contract.

2. The contract amount upon which the requirements set forth in paragraph (1) of Section VI is computed includes the cost of material and manufactured products which are to be purchased or produced by the contractor under the contract provisions.

3. The contractor shall furnish (a) a competent superintendent or supervisor who is employed by the firm, has full authority to direct performance of the work in accordance with the contract requirements, and is in charge of all construction operations (regardless of who performs the work) and (b) such other of its own organizational resources (supervision, management, and engineering services) as the contracting officer determines is necessary to assure the performance of the contract.

4. No portion of the contract shall be sublet, assigned or otherwise disposed of except with the written consent of the contracting officer, or authorized representative, and such consent when given shall not be construed to relieve the contractor of any responsibility for the fulfillment of the contract. Written consent will be given only after the contracting agency has assured that each subcontract is evidenced in writing and that it contains all pertinent provisions and requirements of the prime contract.

5. The 30% self-performance requirement of paragraph (1) is not applicable to design-build contracts; however, contracting agencies may establish their own self-performance requirements.

## VII. SAFETY: ACCIDENT PREVENTION

This provision is applicable to all Federal-aid construction contracts and to all related subcontracts.

1. In the performance of this contract the contractor shall comply with all applicable Federal, State, and local laws governing safety, health, and sanitation (23 CFR 635). The contractor shall provide all safeguards, safety devices and protective equipment and take any other needed actions as it determines, or as the contracting officer may determine, to be reasonably necessary to protect the life

and health of employees on the job and the safety of the public and to protect property in connection with the performance of the work covered by the contract.

2. It is a condition of this contract, and shall be made a condition of each subcontract, which the contractor enters into pursuant to this contract, that the contractor and any subcontractor shall not permit any employee, in performance of the contract, to work in surroundings or under conditions which are unsanitary, hazardous or dangerous to his/her health or safety, as determined under construction safety and health standards (29 CFR 1926) promulgated by the Secretary of Labor, in accordance with Section 107 of the Contract Work Hours and Safety Standards Act (40 U.S.C. 3704).

3. Pursuant to 29 CFR 1926.3, it is a condition of this contract that the Secretary of Labor or authorized representative thereof, shall have right of entry to any site of contract performance to inspect or investigate the matter of compliance with the construction safety and health standards and to carry out the duties of the Secretary under Section 107 of the Contract Work Hours and Safety Standards Act (40 U.S.C.3704).

## VIII. FALSE STATEMENTS CONCERNING HIGHWAY PROJECTS

This provision is applicable to all Federal-aid construction contracts and to all related subcontracts.

In order to assure high quality and durable construction in conformity with approved plans and specifications and a high degree of reliability on statements and representations made by engineers, contractors, suppliers, and workers on Federal-aid highway projects, it is essential that all persons concerned with the project perform their functions as carefully, thoroughly, and honestly as possible. Willful falsification, distortion, or misrepresentation with respect to any facts related to the project is a violation of Federal law. To prevent any misunderstanding regarding the seriousness of these and similar acts, Form FHWA-1022 shall be posted on each Federal-aid highway project (23 CFR 635) in one or more places where it is readily available to all persons concerned with the project:

18 U.S.C. 1020 reads as follows:

"Whoever, being an officer, agent, or employee of the United States, or of any State or Territory, or whoever, whether a person, association, firm, or corporation, knowingly makes any false statement, false representation, or false report as to the character, quality, quantity, or cost of the material used or to be used, or the quantity or quality of the work performed or to be performed, or the cost thereof in connection with the submission of plans, maps, specifications, contracts, or costs of construction on any highway or related project submitted for approval to the Secretary of Transportation; or

Whoever knowingly makes any false statement, false representation, false report or false claim with respect to the character, quality, quantity, or cost of any work performed or to be performed, or materials furnished or to be furnished, in connection with the construction of any highway or related project approved by the Secretary of Transportation; or

Whoever knowingly makes any false statement or false representation as to material fact in any statement, certificate, or report submitted pursuant to provisions of the Federal-aid Roads

Act approved July 1, 1916, (39 Stat. 355), as amended and supplemented;

Shall be fined under this title or imprisoned not more than 5 years or both."

## **IX. IMPLEMENTATION OF CLEAN AIR ACT AND FEDERAL WATER POLLUTION CONTROL ACT**

This provision is applicable to all Federal-aid construction contracts and to all related subcontracts.

By submission of this bid/proposal or the execution of this contract, or subcontract, as appropriate, the bidder, proposer, Federal-aid construction contractor, or subcontractor, as appropriate, will be deemed to have stipulated as follows:

1. That any person who is or will be utilized in the performance of this contract is not prohibited from receiving an award due to a violation of Section 508 of the Clean Water Act or Section 306 of the Clean Air Act.

2. That the contractor agrees to include or cause to be included the requirements of paragraph (1) of this Section X in every subcontract, and further agrees to take such action as the contracting agency may direct as a means of enforcing such requirements.

## **X. CERTIFICATION REGARDING DEBARMENT, SUSPENSION, INELIGIBILITY AND VOLUNTARY EXCLUSION**

This provision is applicable to all Federal-aid construction contracts, design-build contracts, subcontracts, lower-tier subcontracts, purchase orders, lease agreements, consultant contracts or any other covered transaction requiring FHWA approval or that is estimated to cost \$25,000 or more – as defined in 2 CFR Parts 180 and 1200.

### **1. Instructions for Certification – First Tier Participants:**

a. By signing and submitting this proposal, the prospective first tier participant is providing the certification set out below.

b. The inability of a person to provide the certification set out below will not necessarily result in denial of participation in this covered transaction. The prospective first tier participant shall submit an explanation of why it cannot provide the certification set out below. The certification or explanation will be considered in connection with the department or agency's determination whether to enter into this transaction. However, failure of the prospective first tier participant to furnish a certification or an explanation shall disqualify such a person from participation in this transaction.

c. The certification in this clause is a material representation of fact upon which reliance was placed when the contracting agency determined to enter into this transaction. If it is later determined that the prospective participant knowingly rendered an erroneous certification, in addition to other remedies available to the Federal Government, the contracting agency may terminate this transaction for cause of default.

d. The prospective first tier participant shall provide immediate written notice to the contracting agency to whom this proposal is submitted if any time the prospective first tier participant learns that its certification was erroneous when submitted or has become erroneous by reason of changed circumstances.

e. The terms "covered transaction," "debarred," "suspended," "ineligible," "participant," "person," "principal," and "voluntarily excluded," as used in this clause, are defined in 2 CFR Parts 180 and 1200. "First Tier Covered Transactions" refers to any covered transaction between a grantee or subgrantee of Federal funds and a participant (such as the prime or general contract). "Lower Tier Covered Transactions" refers to any covered transaction under a First Tier Covered Transaction (such as subcontracts). "First Tier Participant" refers to the participant who has entered into a covered transaction with a grantee or subgrantee of Federal funds (such as the prime or general contractor). "Lower Tier Participant" refers to any participant who has entered into a covered transaction with a First Tier Participant or other Lower Tier Participants (such as subcontractors and suppliers).

f. The prospective first tier participant agrees by submitting this proposal that, should the proposed covered transaction be entered into, it shall not knowingly enter into any lower tier covered transaction with a person who is debarred, suspended, declared ineligible, or voluntarily excluded from participation in this covered transaction, unless authorized by the department or agency entering into this transaction.

g. The prospective first tier participant further agrees by submitting this proposal that it will include the clause titled "Certification Regarding Debarment, Suspension, Ineligibility and Voluntary Exclusion-Lower Tier Covered Transactions," provided by the department or contracting agency, entering into this covered transaction, without modification, in all lower tier covered transactions and in all solicitations for lower tier covered transactions exceeding the \$25,000 threshold.

h. A participant in a covered transaction may rely upon a certification of a prospective participant in a lower tier covered transaction that is not debarred, suspended, ineligible, or voluntarily excluded from the covered transaction, unless it knows that the certification is erroneous. A participant is responsible for ensuring that its principals are not suspended, debarred, or otherwise ineligible to participate in covered transactions. To verify the eligibility of its principals, as well as the eligibility of any lower tier prospective participants, each participant may, but is not required to, check the Excluded Parties List System website (<https://www.epls.gov/>), which is compiled by the General Services Administration.

i. Nothing contained in the foregoing shall be construed to require the establishment of a system of records in order to render in good faith the certification required by this clause. The knowledge and information of the prospective participant is not required to exceed that which is normally possessed by a prudent person in the ordinary course of business dealings.

j. Except for transactions authorized under paragraph (f) of these instructions, if a participant in a covered transaction knowingly enters into a lower tier covered transaction with a person who is suspended, debarred, ineligible, or voluntarily excluded from participation in this transaction, in addition to other remedies available to the Federal Government, the department or agency may terminate this transaction for cause or default.

\* \* \* \* \*

## **2. Certification Regarding Debarment, Suspension, Ineligibility and Voluntary Exclusion – First Tier Participants:**

a. The prospective first tier participant certifies to the best of its knowledge and belief, that it and its principals:

(1) Are not presently debarred, suspended, proposed for debarment, declared ineligible, or voluntarily excluded from participating in covered transactions by any Federal department or agency;

(2) Have not within a three-year period preceding this proposal been convicted of or had a civil judgment rendered against them for commission of fraud or a criminal offense in connection with obtaining, attempting to obtain, or performing a public (Federal, State or local) transaction or contract under a public transaction; violation of Federal or State antitrust statutes or commission of embezzlement, theft, forgery, bribery, falsification or destruction of records, making false statements, or receiving stolen property;

(3) Are not presently indicted for or otherwise criminally or civilly charged by a governmental entity (Federal, State or local) with commission of any of the offenses enumerated in paragraph (a)(2) of this certification; and

(4) Have not within a three-year period preceding this application/proposal had one or more public transactions (Federal, State or local) terminated for cause or default.

b. Where the prospective participant is unable to certify to any of the statements in this certification, such prospective participant shall attach an explanation to this proposal.

## **2. Instructions for Certification - Lower Tier Participants:**

(Applicable to all subcontracts, purchase orders and other lower tier transactions requiring prior FHWA approval or estimated to cost \$25,000 or more - 2 CFR Parts 180 and 1200)

a. By signing and submitting this proposal, the prospective lower tier is providing the certification set out below.

b. The certification in this clause is a material representation of fact upon which reliance was placed when this transaction was entered into. If it is later determined that the prospective lower tier participant knowingly rendered an erroneous certification, in addition to other remedies available to the Federal Government, the department, or agency with which this transaction originated may pursue available remedies, including suspension and/or debarment.

c. The prospective lower tier participant shall provide immediate written notice to the person to which this proposal is submitted if at any time the prospective lower tier participant learns that its certification was erroneous by reason of changed circumstances.

d. The terms "covered transaction," "debarred," "suspended," "ineligible," "participant," "person," "principal," and "voluntarily excluded," as used in this clause, are defined in 2 CFR Parts 180 and 1200. You may contact the person to which this proposal is submitted for assistance in obtaining a copy of those regulations. "First Tier Covered Transactions" refers to any covered transaction

between a grantee or subgrantee of Federal funds and a participant (such as the prime or general contract). "Lower Tier Covered Transactions" refers to any covered transaction under a First Tier Covered Transaction (such as subcontracts). "First Tier Participant" refers to the participant who has entered into a covered transaction with a grantee or subgrantee of Federal funds (such as the prime or general contractor). "Lower Tier Participant" refers to any participant who has entered into a covered transaction with a First Tier Participant or other Lower Tier Participants (such as subcontractors and suppliers).

e. The prospective lower tier participant agrees by submitting this proposal that, should the proposed covered transaction be entered into, it shall not knowingly enter into any lower tier covered transaction with a person who is debarred, suspended, declared ineligible, or voluntarily excluded from participation in this covered transaction, unless authorized by the department or agency with which this transaction originated.

f. The prospective lower tier participant further agrees by submitting this proposal that it will include this clause titled "Certification Regarding Debarment, Suspension, Ineligibility and Voluntary Exclusion-Lower Tier Covered Transaction," without modification, in all lower tier covered transactions and in all solicitations for lower tier covered transactions exceeding the \$25,000 threshold.

g. A participant in a covered transaction may rely upon a certification of a prospective participant in a lower tier covered transaction that is not debarred, suspended, ineligible, or voluntarily excluded from the covered transaction, unless it knows that the certification is erroneous. A participant is responsible for ensuring that its principals are not suspended, debarred, or otherwise ineligible to participate in covered transactions. To verify the eligibility of its principals, as well as the eligibility of any lower tier prospective participants, each participant may, but is not required to, check the Excluded Parties List System website (<https://www.epls.gov/>), which is compiled by the General Services Administration.

h. Nothing contained in the foregoing shall be construed to require establishment of a system of records in order to render in good faith the certification required by this clause. The knowledge and information of participant is not required to exceed that which is normally possessed by a prudent person in the ordinary course of business dealings.

i. Except for transactions authorized under paragraph e of these instructions, if a participant in a covered transaction knowingly enters into a lower tier covered transaction with a person who is suspended, debarred, ineligible, or voluntarily excluded from participation in this transaction, in addition to other remedies available to the Federal Government, the 11 department or agency with which this transaction originated may pursue available remedies, including suspension and/or debarment.

\* \* \* \* \*

## **Certification Regarding Debarment, Suspension, Ineligibility and Voluntary Exclusion--Lower Tier Participants:**

1. The prospective lower tier participant certifies, by submission of this proposal, that neither it nor its principals is presently debarred, suspended, proposed for debarment, declared ineligible, or

voluntarily excluded from participating in covered transactions by any Federal department or agency.

2. Where the prospective lower tier participant is unable to certify to any of the statements in this certification, such prospective participant shall attach an explanation to this proposal.

\* \* \* \* \*

## **XI. CERTIFICATION REGARDING USE OF CONTRACT FUNDS FOR LOBBYING**

This provision is applicable to all Federal-aid construction contracts and to all related subcontracts which exceed \$100,000 (49 CFR 20).

1. The prospective participant certifies, by signing and submitting this bid or proposal, to the best of his or her knowledge and belief, that:

a. No Federal appropriated funds have been paid or will be paid, by or on behalf of the undersigned, to any person for influencing or attempting to influence an officer or employee of any Federal agency, a Member of Congress, an officer or employee of Congress, or an employee of a Member of Congress in connection with the awarding of any Federal contract, the making of any Federal grant, the making of any Federal loan, the entering into of any cooperative agreement, and the extension, continuation, renewal, amendment, or modification of any Federal contract, grant, loan, or cooperative agreement.

b. If any funds other than Federal appropriated funds have been paid or will be paid to any person for influencing or attempting to influence an officer or employee of any Federal agency, a Member of Congress, an officer or employee of Congress, or an employee of a Member of Congress in connection with this Federal contract, grant, loan, or cooperative agreement, the undersigned shall complete and submit Standard Form-LLL, "Disclosure Form to Report Lobbying," in accordance with its instructions.

2. This certification is a material representation of fact upon which reliance was placed when this transaction was made or entered into. Submission of this certification is a prerequisite for making or entering into this transaction imposed by 31 U.S.C. 1352. Any person who fails to file the required certification shall be subject to a civil penalty of not less than \$10,000 and not more than \$100,000 for each such failure.

3. The prospective participant also agrees by submitting its bid or proposal that the participant shall require that the language of this certification be included in all lower tier subcontracts, which exceed \$100,000 and that all such recipients shall certify and disclose accordingly.

**Replace section 7-1.11C with:****FEMALE AND MINORITY GOALS (Required Federal Language)**

To comply with Section II, "Nondiscrimination," of "Required Contract Provisions Federal-Aid Construction Contracts," the following female and minority utilization goals for Federal-aid construction contracts and subcontracts that exceed \$10,000.

The nationwide goal for female utilization is 6.9 percent.

The goals for minority utilization [45 Fed Reg 65984 (10/3/1980)] are as follows:

**MINORITY UTILIZATION GOALS**

	Economic Area	Goal (Percent)
174	Redding CA: Non-SMSA Counties: CA Lassen; CA Modoc; CA Plumas; CA Shasta; CA Siskiyou; CA Tehema	6.8
175	Eureka, CA Non-SMSA Counties: CA Del Norte; CA Humboldt; CA Trinity	6.6
176	San Francisco-Oakland-San Jose, CA: SMSA Counties: 7120 Salinas-Seaside-Monterey, CA CA Monterey 7360 San Francisco-Oakland CA Alameda; CA Contra Costa; CA Marin; CA San Francisco; CA San Mateo 7400 San Jose, CA CA Santa Clara, CA 7485 Santa Cruz, CA CA Santa Cruz 7500 Santa Rosa CA Sonoma 8720 Vallejo-Fairfield-Napa, CA CA Napa; CA Solano Non-SMSA Counties: CA Lake; CA Mendocino; CA San Benito	28.9    25.6  19.6  14.9  9.1  17.1  23.2
177	Sacramento, CA: SMSA Counties: 6920 Sacramento, CA CA Placer; CA Sacramento; CA Yolo Non-SMSA Counties CA Butte; CA Colusa; CA El Dorado; CA Glenn; CA Nevada; CA Sierra; CA Sutter; CA Yuba	16.1  14.3
178	Stockton-Modesto, CA: SMSA Counties: 5170 Modesto, CA CA Stanislaus 8120 Stockton, CA CA San Joaquin Non-SMSA Counties CA Alpine; CA Amador; CA Calaveras; CA Mariposa; CA Merced; CA Toulumne	12.3  24.3  19.8
179	Fresno-Bakersfield, CA SMSA Counties: 0680 Bakersfield, CA CA Kern	19.1

	2840 Fresno, CA CA Fresno Non-SMSA Counties: CA Kings; CA Madera; CA Tulare	26.1 23.6
180	Los Angeles, CA: SMSA Counties: 0360 Anaheim-Santa Ana-Garden Grove, CA CA Orange 4480 Los Angeles-Long Beach, CA CA Los Angeles 6000 Oxnard-Simi Valley-Ventura, CA CA Ventura 6780 Riverside-San Bernardino-Ontario, CA CA Riverside; CA San Bernardino 7480 Santa Barbara-Santa Maria-Lompoc, CA CA Santa Barbara Non-SMSA Counties CA Inyo; CA Mono; CA San Luis Obispo	11.9 28.3 21.5 19.0 19.7 24.6
181	San Diego, CA: SMSA Counties 7320 San Diego, CA CA San Diego Non-SMSA Counties CA Imperial	16.9 18.2

For the last full week of July during which work is performed under the contract, the prime contractor and each non material-supplier subcontractor with a subcontract of \$10,000 or more must complete Form FHWA PR-1391 (Appendix C to 23 CFR 230). Submit the forms by August 15.

***Replace section 7-1.11D Training with:***

**FEDERAL TRAINEE PROGRAM (Required Federal Language)**

For the Federal training program, the number of trainees or apprentices is **3 (Three)**.

This section applies if a number of trainees or apprentices is specified in the special provisions.

As part of the prime contractor's equal opportunity affirmative action program, provide on-the-job training to develop full journeymen in the types of trades or job classifications involved.

The prime contractor has primary responsibility for meeting this training requirement.

If the prime contractor subcontracts a contract part, they shall determine how many trainees or apprentices are to be trained by the subcontractor. Include these training requirements in each subcontract.

Where feasible, 25 percent of apprentices or trainees in each occupation must be in their 1st year of apprenticeship or training.

Distribute the number of apprentices or trainees among the work classifications on the basis of the prime contractor's needs and the availability of journeymen in the various classifications within a reasonable recruitment area.

Before starting work, the prime contractor shall submit to the County of Humboldt:



1. Number of apprentices or trainees to be trained for each classification
2. Training program to be used
3. Training starting date for each classification

The prime contractor shall obtain the County of Humboldt approval for this submitted information before the prime contractor starts work. The County of Humboldt credits the prime contractor for each apprentice or trainee the prime contractor employs on the job who is currently enrolled or becomes enrolled in an approved program.

The primary objective of this section is to train and upgrade minorities and women toward journeyman status. The prime contractor shall make every effort to enroll minority and women apprentices or trainees, such as conducting systematic and direct recruitment through public and private sources likely to yield minority and women apprentices or trainees, to the extent they are available within a reasonable recruitment area and show that they have made the efforts. In making these efforts, the prime contractor shall not discriminate against any applicant for training.

The prime contractor shall not employ as an apprentice or trainee an employee:

1. In any classification in which the employee has successfully completed a training course leading to journeyman status or in which the employee has been employed as a journeyman
2. Who is not registered in a program approved by the US Department of Labor, Bureau of Apprenticeship and Training

The prime contractor shall ask the employee if the employee has successfully completed a training course leading to journeyman status or has been employed as a journeyman. The prime contractor's records must show the employee's answers to the questions.

In the training program, the prime contractor shall establish the minimum length and training type for each classification. The County of Humboldt and FHWA approves a program if one of the following is met:

1. It is calculated to:
  - Meet the your equal employment opportunity responsibilities
  - Qualify the average apprentice or trainee for journeyman status in the classification involved by the end of the training period
2. It is registered with the U.S. Department of Labor, Bureau of Apprenticeship and Training, and it is administered in a way consistent with the equal employment responsibilities of Federal-aid highway construction contracts

The prime contractor shall obtain the State's approval for their training program before they start work involving the classification covered by the program.

The prime contractor shall provide training in the construction crafts, not in clerk-typist or secretarial-type positions. Training is allowed in lower level management positions such as office engineers, estimators, and timekeepers if the training is oriented toward construction applications. Training is allowed in the laborer classification if significant and meaningful training is provided and approved by the division office. Off-site training is an integral part of an approved training program and does not make up a significant part of the overall training.

The County of Humboldt of reimburses the prime contractor 80 cents per hour of training given an employee on this contract under an approved training program:

- 1. For on-site training
- 2. For off-site training if the apprentice or trainee is currently employed on a Federal-aid project and prime contractor does at least one of the following:
  - a. Contribute to the cost of the training
  - b. Provide the instruction to the apprentice or trainee
  - c. Pay the apprentice's or trainee's wages during the off-site training period
- 3. If the prime contractor complies with this section.

Each apprentice or trainee must:

- 1. Begin training on the project as soon as feasible after the start of work involving the apprentice's or trainee's skill
- 2. Remain on the project as long as training opportunities exist in the apprentice's or trainee's work classification or until the apprentice or trainee has completed the training program

The prime contractor shall furnish the apprentice or trainee with a copy of the program that the prime contractor will comply with in providing the training.



**8 PROSECUTION AND PROGRESS**

*Replace section 8-1.04B, paragraph 1&2:*

**BEGINNING OF WORK (Required Federal Language)**

The Contractor shall begin work within fifty-five calendar days after the contract has been executed by the Board of Supervisors of the County of Humboldt, provided he has received a written "Notice to Proceed" from the Engineer in accordance with Section 4 of the contract Agreement.

*Replace Reserved in section 8-1.04C with:*

**BEGINNING OF WORK (Required Federal Language)**

Section 8-1.04B does not apply.

Start job site activities within 55 days after receiving notice that the Contract has been approved by the Attorney General or the attorney appointed and authorized to represent the Department.

Do not start job site activities until the Department authorizes or accepts your submittal for:

1. CPM baseline schedule
2. [SWPPP](#)
3. [Steel soldier piling](#)

If the submittals for Contractor-supplied biologist and biological resource information program are authorized, you may enter the job site only to measure controlling field dimensions and locate utilities. You may enter the job site only to measure controlling field dimensions and locate utilities.

Do not start other job site activities until all the submittals from the above list are authorized or accepted and the following information is received by the Engineer:

1. Written statement from the vendor that the order for structural steel has been received and accepted by the vendor. The statement must show the dates that the materials will be shipped.

You may start job site activities before the 55th day after Contract approval if you:

1. Obtain specified authorization or acceptance for each submittal before the 55th day
2. Receive authorization to start

Submit a notice 72 hours before starting job site activities. If the project has more than 1 location of work, submit a separate notice for each location.

*Replace section 8-1.05, paragraph 2:*

**TIME OF COMPLETION (Required Federal Language)**

Said work shall be diligently prosecuted to completion before the expiration of:

**120 WORKING DAYS**

Tabulation of working days shall begin on the **fifty-fifth** calendar day after execution of the contract by the Board of Supervisors of the County of Humboldt. If said **fifty-fifth** calendar day falls on a Saturday, Sunday, or legal Holiday, then the first working day for beginning tabulation will be the first working day prior to said Saturday, Sunday or Holiday.

*Replace section 8-1.10A, paragraph 1:*

The County of Humboldt specifies liquidated damages (Pub Cont Code § 10226). Liquidated damages, if any, accrue starting on the 1st day after the expiration of the working days through the day of Contract acceptance

Neither the Contract, nor any moneys due or to become due under the Contract, may be assigned by the Contractor without the prior consent of the Contractor's surety or sureties, unless such surety or sureties have waived their right to notice of assignment. The performance of the Contract may not be assigned without prior written consent of the County of Humboldt.

*Add to section 8-1.10A:*

**LIQUIDATED DAMAGES** (Required Federal Language)

The Contractor shall pay to the County of Humboldt the sum of **\$4,800** per day, for each and every calendar days' delay in finishing the work in excess of the number of working days prescribed above.

^^

**9 PAYMENT**

*Replace section 9-1.16F with:*

**PROMPT PAYMENT FROM THE COUNTY TO THE CONTRACTORS**  
(Required Federal Language)

The County shall make any progress payment within 30 days after receipt of an undisputed and properly submitted payment request from a contractor on a construction contract. If the County fails to pay promptly, the County shall pay interest to the contractor, which accrues at the rate of 10 percent per annum on the principal amount of a money judgment remaining unsatisfied. Upon receipt of a payment request, the County shall act in accordance with both of the following:

1. Each payment request shall be reviewed by the County as soon as practicable after receipt for the purpose of determining that it is a proper payment request.
2. Any payment request determined not to be a proper payment request suitable for payment shall be returned to the contractor as soon as practicable, but not later than seven (7) days, after receipt. A request returned pursuant to this paragraph shall be accompanied by a document setting forth in writing the reasons why the payment request is not proper.

*Replace section 9-1.17B:*

After Contract acceptance by the Board of Supervisors of the County of Humboldt, the Department pays you based on the Engineer-prepared estimate that includes retention, withholds and the balance due after deduction of previous payments.

*Replace sections 9-1.17(D) through 9-1.22, with the following:*

**9-1.17D Final Payment and Claims**

**9-1.17D(1)** Sections 9-1.17D through 9-1.22 of the Standard Specifications shall be replaced with the following provisions as required by California Public Contract Code Section 9204 .

**9-1.17D(2)** For purposes of this section:

1. “Claim” means a separate demand by a contractor sent by registered mail or certified mail with return receipt requested, for one or more of the following:
  - 1.1 A time extension, including, without limitation, for relief from damages or penalties for delay assessed by a public entity under a contract for a public works project.
  - 1.2 Payment by the public entity of money or damages arising from work done by, or on behalf of, the contractor pursuant to the contract for a public works project and payment for which is not otherwise expressly provided or to which the claimant is not otherwise entitled.
  - 1.3 Payment of an amount that is disputed by the public entity.
2. “Contractor” means any type of contractor within the meaning of Chapter 9 (commencing with Section 7000) of Division 3 of the California Business and Professions Code who has entered into a direct contract with a public entity for a public works project.
3. “Public entity” means, without limitation, except as provided herein, a state agency, department, office, division, bureau, board, or commission, the California State University, the University of California, a city, including a charter city, county, including a charter county, city and county, including a charter city and county, district, special district, public authority, political subdivision, public corporation, or nonprofit transit corporation wholly owned by a public agency and formed to carry out the purposes of the public agency. However, the term “public entity” shall not include any of the following:
  - 3.1 The Department of Water Resources as to any project under the jurisdiction of that department.
  - 3.2 The Department of Transportation as to any project under the jurisdiction of that department.
  - 3.3 The Department of Parks and Recreation as to any project under the jurisdiction of that department.
  - 3.4 The Department of Correction and Rehabilitation with respect to any project under its jurisdiction pursuant to Chapter 11 (commencing with section 7000) of Title 7 of Part 3 of the California Penal Code.
  - 3.5 The Military Department as to any project under the jurisdiction of that department.
  - 3.6 The Department of General Services as to all other projects.
  - 3.7 The High-Speed Rail Authority.

4. “Public works project” means the erection, construction, alteration, repair, or improvement of any public structure, building, road, or other public improvement of any kind.
5. “subcontractor” means any type of contractor within the meaning of Chapter 9 (commencing with Section 7000) of Division 3 of the California Business and Professions Code who either is in direct contract with a contractor or is a lower tier subcontractor.

**9-1.17D(3)(a)** Upon receipt of a claim pursuant to this section, the public entity to which the claim applies shall conduct a reasonable review of the claim and, within a period not to exceed 45 days, shall provide the claimant a written statement identifying what portion of the claim is disputed and what portion is undisputed. Upon receipt of a claim, a public entity and a contractor may, by mutual agreement, extend the time period provided in this subdivision.

**9-1.17D(3)(b)** The claimant shall furnish reasonable documentation to support the claim.

**9-1.17D(3)(c)** If the public entity needs approval from its governing body to provide the claimant a written statement identifying the disputed portion and the undisputed portion of the claim, and the governing body does not meet within the 45 days or within the mutually agreed to extension of time following receipt of a claim sent by registered mail or certified mail, return receipt requested, the public entity shall have up to three days following the next duly publicly noticed meeting of the governing body after the 45-day period, or extension, expires to provide the claimant a written statement identifying the disputed portion and the undisputed portion.

**9-1.17D(3)(d)** Any payment due on an undisputed portion of the claim shall be processed and made within 60 days after the public entity issues its written statement. If the public entity fails to issue a written statement, paragraph (3) shall apply.

**9-1.17D(4)(a)** If the claimant disputes the public entity's written response, or if the public entity fails to respond to a claim issued pursuant to this section within the time prescribed, the claimant may demand in writing an informal conference to meet and confer for settlement of the issues in dispute. Upon receipt of a demand in writing sent by registered mail or certified mail, return receipt requested, the public entity shall schedule a meet and confer conference within 30 days for settlement of the dispute.

**9-1.17D(4)(b)** Within 10 business days following the conclusion of the meet and confer conference, if the claim or any portion of the claim remains in dispute, the public entity shall provide the claimant a written statement identifying the portion of the claim that remains in dispute and the portion that is undisputed. Any payment due on an undisputed portion of the claim shall be processed and made within 60 days after the public entity issues its written statement. Any disputed portion of the claim, as identified by the contractor in writing, shall be submitted to nonbinding mediation, with the public entity and the claimant sharing the associated costs equally. The public entity and claimant shall mutually agree to a mediator within 10 business days after the disputed portion of the claim has been identified in writing. If the parties cannot agree upon a mediator, each party shall select a mediator and those mediators shall select a qualified neutral third party to mediate with regard to the disputed portion of the claim. Each party shall bear the fees and costs charged by its respective mediator in connection with the selection of the neutral mediator. If mediation is unsuccessful, the parts of the claim remaining in dispute shall be subject to applicable procedures outside this section.

**9-1.17D(4)(c)** For purposes of this section, mediation includes any nonbinding process, including, but not limited to, neutral evaluation or a dispute review board, in which an independent third party or



## DIVISION II GENERAL CONSTRUCTION

### 12 TEMPORARY TRAFFIC CONTROL

***Add to section 12-1.01:***

Submit a Traffic Control Plan that shows methods for maintaining traffic at all locations within the project limits. Maintaining traffic includes automobiles, bicycles, and pedestrians. Road closures or holding traffic longer than 15 minutes will need 2 weeks public notice.

***Replace Reserved in section 12-3.11B(5) with:***

A construction project funding sign must comply with the details shown on the California Department of Transportation's Traffic Operations website (<http://www.dot.ca.gov/trafficops/tcd/pfi.html>).

The sign must be a wood-post sign complying with section 82-3.

The sign panels must be framed, single-sheet aluminum panels complying with section 82-2.

The background on the sign must be Type II retroreflective sheeting. The Type II retroreflective sheeting must be on the Authorized Material List for signing and delineation materials.

The legend must be retroreflective except for nonreflective black letters and numerals. The blue must match PR color no. 3 on FHWA's Color Tolerance Chart. The orange must match PR color no. 6 on FHWA's Color Tolerance Chart.

***Replace the 3rd paragraphs of section 12-6.04 with:***

Temporary pavement marking is included in the bid item "Traffic Control System" and conform to Section 12-6.03D(5).

The legend for the type of project must read as follows:

ROADWAY REPAIR

The legend for the types of funding on a construction project funding sign must read as follows and in the following order:

COUNTY OF HUMBOLDT, FHWA

The Engineer provides the year of completion for the legend on the sign. Install a sign overlay for the year of completion within 15 days of notification.

Do not add information to the construction project funding sign unless authorized.

***Replace Reserved in section 12-3.11C(3) with:***

Install 2 Type 1 construction project funding sign at the location determined by the Engineer before starting major work activities visible to highway users.



Dispose of construction project funding signs upon completion of the project if authorized.

***Replace the last paragraph of section 12-4.01 with:***

Notify the local authorities in writing of your intent to begin work at least 5 days before work is to start. Submit a copy of the notice and send it to the local authorities before commencement of construction. Cooperate with local authorities to handle traffic through the area and make arrangements to keep the working area clear of parked vehicles. The local authorities must consist of:

1. Humboldt County Sheriff Department - (707) 445-7251

***Add to the end of section 12-4.02C(3)(a):***

If work vehicles or equipment are parked on the shoulder within 6 feet of a traffic lane, close the shoulder area with fluorescent-orange traffic cones or portable delineators. Place the cones or delineators on a taper in advance of the parked vehicles or equipment and along the edge of the traveled way at 25-foot intervals to a point not less than 25 feet past the last vehicle or piece of equipment. Use at least 9 cones or delineators for the taper. Place advance warning signs as specified in section 12-4.02C(8).

Keep a minimum of 1 traffic lane at least 10 feet wide open for traffic, except the full width of the traveled way must be open when construction operations are not active or an approved traffic control plan is in place.

***Add to the end of the 1st paragraph of section 12-4.02C(7)(a):***

except you may use a moving closure during traffic striping and pavement marker placement using a bituminous adhesive. Do not use a moving lane closure when grinding for recessed striping and recessed markers.

***Add to the end of section 12-4.02C(7)(a):***

After placing components of a stationary traffic control system, you may place the impact attenuator vehicle in advance of the work area or at another authorized location to protect traffic and workers.

***Add to the end of section 12-4.02C(7)(b):***

Closure spacing is the distance between the last cone of the upstream closure and the temporary sign W20-1 of the downstream closure. The number of lanes open in the upstream closures must be less than or equal to the number of lanes open in the downstream closures. For multiple closures in each direction of travel, pick up the downstream closures first.

For a stationary one-way-reversing traffic-control lane closure, you may stop traffic in 1 direction for periods not to exceed 15 minutes. After each stoppage, all accumulated traffic for that direction must pass through the work zone before another stoppage is made.

The maximum length of a single stationary one-way-reversing traffic-control lane closure is a 1/2 mile between flaggers.

For traffic under one-way-reversing traffic control on unpaved areas, the cones shown along the centerline are not required.

You may use a pilot car to control traffic. If a pilot car is used to control traffic, the cones shown along the centerline are not required. Pilot cars must have cellular or radio contact with other pilot cars and personnel in the work zone. The maximum speed of the pilot cars conveying or controlling traffic through the traffic control zone is 25 mph. Pilot cars must only use traffic lanes open to traffic.

^^

**13 WATER POLLUTION CONTROL**

*Insert into section 13-1.01:*

Preliminary calculations by the Engineer indicate that the project’s disturbed soil area is 2.2 acres including stockpile and/or Contractor’s staging area.

Manage work activities in a way that reduces the discharge of pollutants to surface waters, groundwater and separate municipal storm sewer systems.

*Add between the 4th and 5th paragraphs of section 13-3.01C(2)(a):*

The following RWQCBs will review the authorized SWPPP:

- 1. North Coast RWQCB Region 1

^^

**14 ENVIRONMENTAL STEWARDSHIP**

*Add to the 1st paragraph of section 14-6.03A:*

This project is within or near habitat for the regulated species shown in the following table:

<b>Regulated Species</b>
1. Migratory Birds

*Add to section 14-6.03B:*

Contractor shall notify the County two weeks prior to start of clearing and grubbing activities.

The bird nesting season is from February 1<sup>st</sup> through August 31<sup>st</sup>. If vegetation removal or ground disturbance cannot be confined to work during the non-breeding season, the County will have a qualified

biologist conduct preconstruction surveys within the vicinity of the impact area, to check for nesting activity of native birds and to evaluate the site for presence of raptors and special-status bird species. The biologist will conduct a preconstruction survey within the seven-day period prior to vegetation removal and ground-disturbing activities. If ground disturbance and vegetation removal work lapses for seven days or longer during the breeding season, a supplemental avian survey will be required before project work is reinitiated.

If an active nest is found, the biologist will determine the extent of an appropriate construction free buffer zone to be established around the nest and/or operational restrictions in consultation with CDFW. Buffer zones will be delineated with flagging and maintained until the nests have fledged or nesting activity has ceased.

^^

**DIVISION III EARTHWORK AND LANDSCAPE**

**17 GENERAL**

***Replace the 4th paragraph in section 17-2.03A with:***

Clear and grub vegetation only within the excavation and embankment slope lines.

^^

**19 EARTHWORK**

***Replace the 2nd, 3rd, and 4th paragraphs of section 19-2.03B with:***

Dispose of surplus material. Ensure enough material is available to complete the embankments before disposing of it.

***Add to the end of section 19-3.01A:***

Structure backfill includes constructing the geocomposite drain system. The systems must comply with section 68-7.

Delete the 1st paragraph of section 19-3.03B(2).

***Add to section 19-6.02B:***

The LTDS of geosynthetic reinforcement must comply with the requirements shown in the following table:





### Type A HMA Mix Design Requirements

Quality characteristic	Test method	Requirement
Air voids content (%)	AASHTO T 269 <sup>a</sup>	N <sub>initial</sub> > 8.0 N <sub>design</sub> = 4.0 (±2.0%) (N <sub>design</sub> = 5.0 for 1-inch aggregate) N <sub>max</sub> > 2.0
Gyrations compaction (no. of gyrations)	AASHTO T 312	N <sub>initial</sub> = 8 N <sub>design</sub> = 85.0 N <sub>max</sub> = 130
Voids in mineral aggregate (min, %) <sup>b</sup> Gradation: No. 4 3/8-inch 1/2-inch 3/4-inch 1-inch with NMAS = 1-inch with NMAS = 3/4-inch	MS-2 Asphalt Mixture Volumetrics	16.5–19.5 15.5–18.5 14.5–17.5 13.5–16.5 13.5–16.5 14.5–17.5
Dust proportion	MS-2 Asphalt Mixture Volumetrics	0.6–1.3
Hamburg wheel track (min number of passes at 0.55-inch rut depth) Binder grade: PG 58 PG 64 PG 70 PG 76 or higher	AASHTO T 324 (Modified) <sup>c</sup>	10,000 15,000 20,000 25,000

<sup>a</sup>Calculate the air voids content of each specimen using AASHTO T 275, Method A, to determine bulk specific gravity. Use AASHTO T 209, Method A, to determine theoretical maximum specific gravity. Use a digital manometer and pycnometer when performing AASHTO T 209.

<sup>b</sup>Measure bulk specific gravity using AASHTO T 275, Method A.

<sup>c</sup>Test plant-produced Type A HMA.







***Replace Reserved in section 83-2.01B with:*****83-2.01B(1) General****83-2.01B(1)(a) Summary**

Section 83-2.01B includes specifications for constructing vegetation control around railing and barrier posts.

Constructing minor concrete vegetation control includes clearing and excavation.

**83-2.01B(1)(b) Definitions**

Not Used

**83-2.01B(1)(c) Submittals**

Submit a mix design for the minor concrete to be used for vegetation control. The mix design must show proportions of:

1. Coarse aggregate
2. Fine aggregate
3. Cementitious material
4. Reinforcing fiber
5. Water

Include compressive strength test results with the mix design.

Submit a certificate of compliance for the crumb rubber aggregate, if used. Include the quantity in pounds of crumb rubber.

**83-2.01B(1)(d) Quality Assurance**

Not Used

**83-2.01B(2) Materials****83-2.01B(2)(a) General**

Not Used

**83-2.01B(2)(b) Minor Concrete****83-2.01B(2)(b)(i) General**

Concrete for vegetation control must comply with the specifications for minor concrete, except the concrete:

1. Must include reinforcing fibers
2. May include crumb rubber aggregate
3. Must contain:
  - 3.1. At least 505 pounds of cementitious material per cubic yard, if crumb rubber aggregate is used

3.2. At least 400 pounds of cementitious material per cubic yard, if crumb rubber aggregate is not used

4. Must have a maximum aggregate size of 3/8 inch

All ingredients must be added at the concrete plant before delivery to the job site.

You may use volumetric proportioning complying with ASTM C685/C685M or as specified.

The minor concrete must have a 28-day compressive strength from 1,400 to 2,500 psi.

### **83-2.01B(2)(b)(ii) Crumb Rubber Aggregate**

Crumb rubber aggregate must consist of ground or granulated scrap tire rubber from automobile and truck tires. Do not use tire buffings.

Crumb rubber aggregate must be ground and granulated at ambient temperature.

The crumb rubber aggregate gradation must comply with the requirements shown in the following table:

Sieve size	Percentage passing
1/2"	100
3/8"	90–100
1/4"	35–45
No. 4	5–15
No. 8	0–5
No. 16	0

Crumb rubber aggregate must not contain more than 0.01 percent of wire by mass and must be free of oils and volatile organic compounds.

Do not commingle crumb rubber from different sources.

The crumb rubber aggregate must be  $3.5 \pm 0.5$  percent by weight of the concrete.

### **83-2.01B(2)(b)(iii) Reinforcing Fibers**

Reinforcing fibers for minor concrete must be:

1. Manufactured specifically for use as concrete reinforcement from one of the following:
  - 1.1. Polypropylene, polyethylene, or a combination of both.
  - 1.2. Copolymer of polypropylene and polyethylene.
2. Blended ratio from 4 to 5.67 parts by weight of macro synthetic fibers to 1 part by weight of micro synthetic fibers. Synthetic fibers must be:
  - 2.1. Nonfibrillated macro fibers with individual fiber lengths less than  $2 \pm 1/2$  inches.
  - 2.2. Fibrillated or monofilament micro fibers of various lengths and thicknesses.
3. Supplied in sealed, degradable bags of appropriate size for adding whole bags to concrete batches.

4. From a commercial source.

The reinforcing fiber content of the minor concrete must be from 5 to 6 lb/cu yd.

**83-2.01B(2)(b)(iv) Coloring Agent**

Not Used

**83-2.01B(2)(c) Block-Out Material**

The block-out material must be a commercially available expanded polystyrene foam with a compressive strength of  $13 \pm 5$  psi at 10 percent deformation when tested under ASTM D1621.

If authorized, you may substitute an alternative block-out material that complies with the compressive strength requirements of the expanded polystyrene foam.

**83-2.01B(2)(d) Backfill Material**

Backfill material must be Class 2 aggregate base complying with section 26.

**83-2.01B(3) Construction**

**83-2.01B(3)(a) General**

Not Used

**83-2.01B(3)(b) Clearing**

Clear areas to receive vegetation control of vegetation, trash, and debris. Dispose of the removed material.

**83-2.01B(3)(c) Earthwork**

Excavate or backfill areas to receive vegetation control.

If the vegetation control abuts the existing surfacing and the edge of the existing surfacing is not on a neat line, cut the surfacing on a neat line to a minimum depth of 2 inches before removing the surfacing.

Perform grading so that the finished elevation of the vegetation control maintains the existing or planned flow lines, slope gradients, contours, and existing surfacing.

Grade the areas to receive vegetation control to a smooth, uniform surface and compact to a relative compaction of at least 90 percent.

**83-2.01B(3)(d) Block Outs**

For block-out material supplied in more than 1 piece, tape the pieces together to make a smooth surface on the top and sides.

Ensure that the block-out material does not move during concrete placement.

**83-2.01B(3)(e) Forming**

Forming must comply with section 73-1.03C.

Leave forms in place for at least 12 hours after surface finishing.

**83-2.01B(3)(f) Minor Concrete**

Strike off and compact the minor concrete until a layer of mortar is brought to the surface. Match the finished grade to the adjacent section of vegetation control, pavement, shoulder, or existing grade.

Construct contraction joints by scoring concrete with a grooving tool and rounding corners with an edger tool.

**83-2.01B(3)(g) Backfill Material**

Backfill material required for vegetation control under existing guardrail or barrier is change order work. Excavate or backfill areas to receive vegetation control.

**83-2.01B(4) Payment**

Not Used

*Replace Reserved in section 83-2.04B with:*

**83-2.04C(1) General****83-2.04C(1)(a) Summary**

Section 83-2.04C includes specifications for constructing alternative in-line terminal systems.

**83-2.04C(1)(b) Definitions**

Not Used

**83-2.04C(1)(c) Submittals**

Submit a certificate of compliance for alternative in-line terminal systems.

**83-2.04C(1)(d) Quality Assurance**

Not Used

**83-2.04C(2) Materials**

Alternative in-line terminal systems must be one of the following or a Department-authorized equal:

1. Type Soft-Stop In-Line Guardrail terminal system. Type Soft-Stop In-Line Guardrail terminal system must be manufactured by Trinity Highway Products, LLC, and must include the connection components. The Soft-Stop In-Line Guardrail can be obtained from the following manufacturer:

Address	Telephone no.
TRINITY HIGHWAY PRODUCTS LLC PO BOX 99 CENTERVILLE UT 84012	(800) 772-7976

2. Type MASH Sequentially Kinking Terminal. Type MASH Sequentially Kinking Terminal must be manufactured by Trinity Highway Products, LLC, and must include the connection components. The MASH Sequentially Kinking Terminal (8-post system) can be obtained from the following distributors:



***Add to section 96-1.02B:***

Filter fabric must be Class C.

^^

**PROPOSAL  
TO  
THE COUNTY OF HUMBOLDT  
FOR**

**STORM DAMAGE REPAIRS TO ALDERPOINT ROAD (F6B165)  
AT PM 21.8, 22.8, 23.0-23.05 & 23.75  
ER-32L0(329) & ER-32L0(330)  
CONTRACT NO.: 217288 & 217294**

Name of Bidder: \_\_\_\_\_  
(Name must be exactly as it appears [or will appear] on Contractor's license)

Business Address: \_\_\_\_\_  
\_\_\_\_\_

Telephone No.: \_\_\_\_\_

Place of Residence: \_\_\_\_\_

The work for which this proposal is submitted is for construction in accordance with the special provisions (including the payment of not less than the State general prevailing wage rates or Federal minimum wage rates), the project plans described above, including any addenda thereto, the contract annexed hereto and also in accordance with the California Department of Transportation Standard Plans dated 2018, the Standard Specifications dated 2018, and the Labor Surcharge and Equipment Rental Rates in effect at the time the work is performed.

Bids are to be submitted for the entire work. The amount of the bid for comparison purposes will be the total of all items.

The bidder shall set forth for each unit basis item of work a unit price and a total for the item, and for each lump sum item a total for the item, all in clearly legible figures in the respective spaces provided for that purpose. In the case of unit basis items, the amount set forth under the "Item Total" column shall be the product of the unit price bid and the estimated quantity for the item.

In case of discrepancy between the unit price and the total set forth for a unit basis item, the unit price shall prevail, except as provided in (a) or (b), as follows:

- (a) If the amount set forth as a unit price is unreadable or otherwise unclear, or is omitted, or is the same as the amount as the entry in the item total column, then the amount set forth in the item total column for the item shall prevail and shall be divided by the estimated quantity for the item and the price thus obtained shall be the unit price;

- (b) (Decimal Errors) If the product of the entered unit price and the estimated quantity is exactly off by a factor of ten, one hundred, etc., or one-tenth, or one-hundredth, etc. from the entered total, the discrepancy will be resolved by using the entered unit price or item total, whichever most closely approximates percentagewise the unit price or item total in the County of Humboldt's Final Estimate of cost.

If both the unit price and the item total are unreadable or otherwise unclear, or are omitted, the bid may be deemed irregular. Likewise if the item total for a lump sum item is unreadable or otherwise unclear, or is omitted, the bid may be deemed irregular unless the project being bid has only a single item and a clear, readable total bid is provided.

Symbols such as commas and dollar signs will be ignored and have no mathematical significance in establishing any unit price or item total or lump sums. Written unit prices, item totals and lump sums will be interpreted according to the number of digits and, if applicable, decimal placement. Cents symbols also have no significance in establishing any unit price or item total since all figures are assumed to be expressed in dollars and/or decimal fractions of a dollar. Bids on lump sum items shall be item totals only; if any unit price for a lump sum item is included in a bid and it differs from the item total, the items total shall prevail.

The foregoing provisions for the resolution of specific irregularities cannot be so comprehensive as to cover every omission, inconsistency, error or other irregularity which may occur in a bid. Any situation not specifically provided for will be determined in the discretion of the County of Humboldt, and that discretion will be exercised in the manner deemed by the County of Humboldt to best protect the public interest in the prompt and economical completion of the work. The decision of the County of Humboldt respecting the amount of a bid, or the existence or treatment of an irregularity in a bid, shall be final.

All bid proposals and materials submitted in response to this Notice to Bidders shall become the County of Humboldt's property and are subject to disclosure under the Public Records Act, California Government Code Sections 6250, et seq. All bid proposals submitted in response hereto, are considered public information, except for specifically identified trade secrets, which will be handled according to any and all applicable local, state and federal laws and regulations. Any portion of a bid proposal that is deemed to be a trade secret by the bidder shall be clearly marked "PROPRIETARY INFORMATION" at the top of the page in at least one-half inch (1/2") letters. Specifically identified proprietary information will not be released, if the bidder agrees to indemnify and defend the County of Humboldt in any action brought to disclose such information. By submitting a bid proposal in response to this Notice to Bidders, the bidder agrees that the County of Humboldt's failure to contact the bidder prior to the release of any proprietary information contained therein will not be a basis for liability by the County of Humboldt or any employee thereof. Items considered public information will be available for review after the bid opening.

If this proposal shall be accepted and the undersigned shall fail to enter into the contract and furnish the 2 bonds in the sums required by the State Contract Act, with surety satisfactory to the County of Humboldt, within 8 days, not including Saturdays, Sundays and legal holidays, after the bidder has received notice from the County of Humboldt that the contract has been awarded, the County of Humboldt may, at its option, determine that the bidder has abandoned the contract, and thereupon this proposal and the acceptance thereof shall be null and void and the forfeiture of the security accompanying this proposal shall operate and the same shall be the property of the County of Humboldt.



The undersigned, as bidder, declares that the only persons or parties interested in this proposal as principals are those named herein; that this proposal is made without collusion with any other person, firm, or corporation; that he has carefully examined the location of the proposed work, the annexed proposed form of contract, and the plans therein referred to; and he proposes, and agrees if this proposal is accepted, that he will contract with the County of Humboldt, in the form of the copy of the contract annexed hereto, to provide all necessary machinery, tools, apparatus and other means of construction, and to do all the work and furnish all the materials specified in the contract, in the manner and time therein prescribed, and according to the requirements of the Engineer as therein set forth, and that he will take in full payment therefor the following prices, to wit:

**ADDENDUM No. 1**

Attachment 1

**BID FORM (EXHIBIT A) PAGE 1 OF 2**  
**STORM DAMAGE REPAIRS ON ALDERPOINT ROAD**  
**(F6B165) PM 21.8,22.8, 23.0-23.05 & 23.75**  
**PROJECT NO.: ER-32L0(329) & ER-32L0(330)**  
**CONTRACT NO.: 217288 & 217294**

ITEM NO.	ITEM CODE	ITEM DESCRIPTION	UNIT	QTY	UNIT PRICE	TOTAL
1	100100	DEVELOP WATER SUPPLY	LS	1		
2	120090	CONSTRUCTION AREA SIGNS	EA	22		
3	120100	TRAFFIC CONTROL SYSTEM	LS	1		
4	120165	CHANNELIZER (SURFACE MOUNTED)	EA	216		
5	129000	TEMPORARY RAILING (TYPE K)	LF	1,420		
6	129110	TEMPORARY CRASH CUSHION	EA	10		
7	130100	JOB SITE MANAGEMENT	LS	1		
8	130300	PREPARE STORM WATER POLLUTION PREVENTION PLAN	LS	1		
9	130310	RAIN EVENT ACTION PLAN	EA	20		
10	130320	STORM WATER SAMPLING ANALYSIS DAY	DAY	6		
11	130330	STORM WATER ANNUAL REPORT	EA	1		
12	130610	TEMPORARY CHECK DAM	LF	360		
13	130620	TEMPORARY DRAINAGE INLET PROTECTION	EA	5		
14	130680	TEMPORARY SILT FENCE	LF	970		
15	130710	TEMPORARY CONSTRUCTION ENTRANCE	EA	2		
16	130900	TEMPORARY CONCRETE WASHOUT	EA	2		
17	170103	CLEARING AND GRUBBING	LS	1		
18	190101	ROADWAY EXCAVATION	CY	11,510		
19	192049	[F] STRUCTURE EXCAVATION (SOLDIER PILE WALL)	CY	162		
20	193029	[F] STRUCTURE BACKFILL (SOLDIER PILE WALL)	CY	37		
21	193116	[F] CONCRETE BACKFILL (SOLDIER PILE WALL)	CY	40		
22	193119	[F] LEAN CONCRETE BACKFILL	CY	28		
23	198215	SUBGRADE ENHANCEMENT GEOGRID	SY	1,700		
24	210280	ROLLED EROSION CONTROL BLANKET	SQFT	33,035		
25	210420	STRAW	SF	2,580		
26	210350	FIBER ROLLS	LF	2,630		
27	260203	CLASS 2 AGGREGATE BASE	CY	744		
28	390132	HOT MIX ASPHALT (TYPE A)	TON	805		
29	394077	PLACE HOT MIX ASPHALT DIKE (TYPE F)	LF	215		
30	398200	COLD PLANE ASPHALT CONCRETE PAVEMENT	SY	60		
31	460210	[P] GROUND ANCHOR (SUBHORIZONTAL)	EA	15		

**ADDENDUM No. 1  
 BID FORM (EXHIBIT A) PAGE 2 OF 2**

Attachment 1

32	4903XX	[P]	STEEL SOLDIER PILE (W 12 X 65)	LF	642		
33	490400		24" DRILLED HOLE	LF	578		
34	575004	[F]	TIMBER LAGGING	MFBM	14		
35	590120		CLEAN AND PAINT STEEL SOLDIER PILING	LS	1		
36	6411XX	[P]	8" PLASTIC PIPE	LF	14		
37	665016		18" CORRUGATED STEEL PIPE (0.064" THICK)	LF	270		
38	665022		24" CORRUGATED STEEL PIPE (0.064" THICK)	LF	133		
39	665030		30" CORRUGATED STEEL PIPE (0.064" THICK)	LF	62		
40	680254		CLEANOUT ASSEMBLY	EA	9		
41	680902		6" PERFORATED PLASTIC PIPE UNDERDRAIN	LF	1,037		
42	680905		8" PERFORATED PLASTIC PIPE UNDERDRAIN	LF	112		
43	681990		FILTER FABRIC	SY	3,510		
44	682020		CLASS 1 PERMEABLE MATERIAL	CY	2,095		
45	690122		24" CORRUGATED STEEL PIPE DOWNDRAIN (0.064" THICK)	LF	8		
46	692307		18" ANCHOR ASSEMBLY	EA	5		
47	700637		36" CORRUGATED STEEL PIPE INLET	LF	39		
48	710136		REMOVE PIPE	LF	187		
49	723080		ROCK SLOPE PROTECTION (60 lb, Class II, METHOD B)	CY	25		
50	729011		ROCK SLOPE PROTECTION FABRIC (CLASS 8)	SY	111		
51	750001	[F]	MISCELLANEOUS IRON AND STEEL	LB	885		
52	820130		OBJECT MARKER	EA	2		
53	832007		MIDWEST GUARDRAIL SYSTEM (WOOD POST)	LF	113		
54	832070		VEGETATION CONTROL (MINOR CONCRETE)	SY	111		
55	839521	[F]	CABLE RAILING	LF	112		
56	839584		ALTERNATIVE IN-LINE TERMINAL SYSTEM	EA	2		
57	840560		THERMOPLASTIC TRAFFIC STRIPE (SPRAYABLE)	LF	1,160		
58	210212		DRY SEED	SQFT	2,580		
59	665045		48" CORRUGATED STEEL PIPE (0.064" THICK)	LF	60		
60	999990		MOBILIZATION	LS	1		

NOTE: ITEM CODE LETTER DESIGNATION; F= FINAL PAY QUANTITY, P=ITEM ELIGIBLE FOR PARTIAL PAY

**BID TOTAL**

ACKNOWLEDGEMENT OF ADDENDA

<u>ADDENDUM NO.</u> Addendum 1	<u>INITIAL</u>
_____	_____
_____	_____

\_\_\_\_\_  
 (Bidder's Signature)

\_\_\_\_\_  
 (Title)

**PROPOSAL SIGNATURE PAGE**

Accompanying this proposal is \_\_\_\_\_

*(NOTICE: INSERT THE WORDS "CASH (\$\_\_\_)", "CASHIER'S CHECK", "CERTIFIED CHECK", OR "BIDDERS'S BOND", AS THE CASE MAY BE.)*

in the amount of at least **TEN PERCENT (10%)** of the total bid.

The names of all persons interested in the foregoing proposal as Principals are as follows:

\_\_\_\_\_  
\_\_\_\_\_

*(NOTE: If a Bidder or other interested person is a Corporation, state the legal name of the corporation, also names of the president, secretary, treasurer, and manager thereof; if a Co-partnership, state the true name of the firm, also state the names of all individual copartners composing the firm; if the Bidder or other interested person is an Individual, state the first and last names in full.)*

Licensed in accordance with an act providing for the registration of Contractors,

**LICENSE NO.** \_\_\_\_\_ **Classification(s)** \_\_\_\_\_

Note: It is optional to provide your contractors license number at this time. You are not required to provide your contractors license number until the time that the contract is to be awarded.

By my signature on this proposal I certify, under penalty of perjury under the laws of the State of California, that the foregoing questionnaire and statements of Public Contract Code Sections 10162, 10232 and 10285.1 are true and correct and that the bidder has complied with the requirements of Section 8103 of the Fair Employment and Housing Commission Regulations (Chapter 5, Title 2 of the California Administrative Code). By my signature on this proposal I further certify, under penalty of perjury under the laws of the State of California and the United States of America, that the Noncollusion Affidavit required by Title 23 United States Code, Section 112 and Public Contract Code Section 7106; and the Title 49 Code of Federal Regulations, Part 29 Debarment and Suspension Certification are true and correct.

Date: \_\_\_\_\_



\_\_\_\_\_  
\_\_\_\_\_  
\_\_\_\_\_

*Signature and Title of Bidder*

Bidder's Business Address \_\_\_\_\_

\_\_\_\_\_

Place of Residence \_\_\_\_\_

**BIDDER’S BOND**

COUNTY OF HUMBOLDT, DEPARTMENT OF PUBLIC WORKS

**STORM DAMAGE REPAIRS TO ALDERPOINT ROAD (F6B165)  
AT PM 21.8, 22.8, 23.0-23.05 & 23.75  
ER-32L0(329) & ER-32L0(330)  
CONTRACT NO.: 217288 & 217294**

for which bids are to be opened on **TUESDAY, MAY 4, 2021**, at 2:00 PM, in the Office of the Clerk of the Board, Humboldt County Courthouse, in Eureka, California.

**Know all men by these presents:** That we \_\_\_\_\_, as

**PRINCIPAL**, and \_\_\_\_\_,

as **SURETY**, are held and firmly bound unto the County of Humboldt in the penal sum of **TEN PERCENT (10%) OF THE TOTAL AMOUNT OF THE BID** of the **PRINCIPAL** named above, submitted by said **PRINCIPAL** to the County of Humboldt for the work described above, for the payment of which sum is lawful money of the United States, well and truly to be made, to the Director of the Department to which said bid was submitted, we bind ourselves, our heirs, executors, administrators and successors, jointly and severally, firmly by these presents. In no case shall the liability of the **SURETY** hereunder exceed the sum of:

\$ \_\_\_\_\_

**THE CONDITION OF THIS OBLIGATION IS SUCH**, that whereas the **PRINCIPAL** has submitted the above mentioned bid to the County of Humboldt, as aforesaid, for the construction as specifically described above,

**NOW, THEREFORE**, if the aforesaid **PRINCIPAL** is awarded the contract, and within the time and manner required under the Specifications, after the prescribed forms are presented to him for signature, enters into a written contract, in the prescribed form, in accordance with the bid, and files two bonds with the Department, one to guarantee faithful performance and the other to guarantee payment for labor and materials, as required by law, then this obligation shall be null and void; otherwise, it shall be and remain in full force and virtue.

**IN WITNESS WHEREOF**, we have hereunto set our hands and seals on this

\_\_\_\_\_ day of \_\_\_\_\_, 20\_\_\_\_.

\_\_\_\_\_ (seal)

\_\_\_\_\_ (seal)

**PRINCIPAL**

\_\_\_\_\_ (seal)

\_\_\_\_\_ (seal)

**SURETY**

Address: \_\_\_\_\_

Note: Signatures of those executing for **SURETY** must be properly acknowledged.

**CONTRACTOR’S CERTIFICATE REGARDING WORKER’S COMPENSATION**

**Labor Code Section 3700.**

"Every employer except the State and all political subdivisions or institutions thereof, shall secure the payment of compensation in one or more of the foregoing ways:

- A. By being insured against liability to pay compensation by one or more insurers duly authorized to write compensation insurance in this State.
- B. By securing from the Director of Industrial Relations a certificate of consent of self-insure, which may be given upon furnishing proof satisfactory to the Director of Industrial Relations of ability to self-insure and to pay any compensation that may become due to his employees."

I am aware of the provisions of Section 3700 of the Labor Code which requires every employer to be insured against liability for worker's compensation or to undertake self-insurance in accordance with the provisions of that code, and that I will comply with such provisions before commencing the performance of the work of this contract.



---



---



---

(In accordance with Article 5 [commencing at Section 1860 ], Chapter 1 , Part 7 , Division 2 , of the Labor Code, the above certificate must be signed and filed with the awarding body prior to commencing any work under this contract. )

**PUBLIC CONTRACT CODE SECTION 10285.1 STATEMENT**

In conformance with Public Contract Code Section 10285.1 (Chapter 376, Stats. 1985), the bidder hereby declares under penalty of perjury under the laws of the State of California that the bidder has \_\_\_\_, has not \_\_\_\_ been convicted within the preceding three years of any offenses referred to in that section, including any charge of fraud, bribery, collusion, conspiracy, or any other act in violation of any state or Federal antitrust law in connection with the bidding upon, award of, or performance of, any public works contract, as defined in Public Contract Code Section 1101, with any public entity, as defined in Public Contract Code Section 1100, including the Regents of the University of California or the Trustees of the California State University. The term "bidder" is understood to include any partner, member, officer, director, responsible managing officer, or responsible managing employee thereof, as referred to in Section 10285.1.

Note: The bidder must place a check mark after "has" or "has not" in one of the blank spaces provided. The above Statement is part of the Proposal. Signing this Proposal on the signature portion thereof shall also constitute signature of this Statement. Bidders are cautioned that making a false certification may subject the certifier to criminal prosecution.

**PUBLIC CONTRACT CODE SECTION 10162 QUESTIONNAIRE**

In conformance with Public Contract Code Section 10162, the Bidder shall complete, under penalty of perjury, the following questionnaire:

Has the bidder, any officer of the bidder, or any employee of the bidder who has a proprietary interest in the bidder, ever been disqualified, removed, or otherwise prevented from bidding on, or completing a federal, state, or local government project because of a violation of law or a safety regulation?

YES  NO

If the answer is yes, explain the circumstances in the following space.

## **PUBLIC CONTRACT CODE SECTION 10232 STATEMENT**

In conformance with Public Contract Code Section 10232, the Contractor, hereby states under penalty of perjury, that no more than one final unappealable finding of contempt of court by a federal court has been issued against the Contractor within the immediately preceding two-year period because of the Contractor's failure to comply with an order of a federal court which orders the Contractor to comply with an order of the National Labor Relations Board.

Note: The above Statement and Questionnaire are part of the Proposal. Signing this Proposal on the signature portion thereof shall also constitute signature of this Statement and Questionnaire.

Bidders are cautioned that making a false certification may subject the certifier to criminal prosecution.



## DEBARMENT AND SUSPENSION CERTIFICATION

### TITLE 49, CODE OF FEDERAL REGULATIONS, PART 29

The bidder, under penalty of perjury, certifies that, except as noted below, he/she or any other person associated therewith in the capacity of owner, partner, director, officer, manager:

- is not currently under suspension, debarment, voluntary exclusion, or determination of ineligibility by any Federal agency;
- has not been suspended, debarred, voluntarily excluded or determined ineligible by any Federal agency within the past 3 years;
- does not have a proposed debarment pending; and
- has not been indicted, convicted, or had a civil judgement rendered against it by a court of competent jurisdiction in any matter involving fraud or official misconduct within the past 3 years.

If there are any exceptions to this certification, insert the exceptions in the following space.

Exceptions will not necessarily result in denial of award, but will be considered in determining bidder responsibility. For any exception noted above, indicate below to whom it applies, initiating agency, and dates of action.

Notes: Providing false information may result in criminal prosecution or administrative sanctions. The above certification is part of the Proposal. Signing this Proposal on the signature portion thereof shall also constitute signature of this Certification.

*(THE BIDDER'S EXECUTION ON THE SIGNATURE PORTION OF THIS PROPOSAL SHALL ALSO CONSTITUTE AN ENDORSEMENT AND EXECUTION OF THOSE CERTIFICATIONS WHICH ARE A PART OF THIS PROPOSAL)*

### **EQUAL EMPLOYMENT OPPORTUNITY CERTIFICATION**

The bidder \_\_\_\_\_, proposed subcontractor \_\_\_\_\_, hereby certifies that he has \_\_\_\_\_, has not \_\_\_\_\_, participated in a previous contract or subcontract subject to the equal opportunity clauses, as required by Executive Orders 10925, 11114, or 11246, and that, where required, he has filed with the Joint Reporting Committee, the Director of the Office of Federal Contract Compliance, a Federal Government contracting or administering agency, or the former President's Committee on Equal Employment Opportunity, all reports due under the applicable filing requirements.

**Note:** The above certification is required by the Equal Employment Opportunity Regulations of the Secretary of Labor (41 CFR 60-1.7(b) (1)), and must be submitted by bidders and proposed subcontractors only in connection with contracts and subcontracts which are subject to the equal opportunity clause. Contracts and subcontracts which are exempt from the equal opportunity clause are set forth in 41 CFR 60-1.5. (Generally only contracts or subcontracts of \$10,000 or under are exempt.)

Currently, Standard Form 100 (EEO-1) is the only report required by the Executive Orders or their implementing regulations.

Proposed prime contractors and subcontractors who have participated in a previous contract or subcontract subject to the Executive Orders and have not filed the required reports should note that 41 CFR 60-1.7(b) (1) prevents the award of contracts and subcontracts unless such contractor submits a report covering the delinquent period or such other period specified by the Federal Highway Administration or by the Director, Office of Federal Contract Compliance, U.S. Department of Labor.

**NONCOLLUSION AFFIDAVIT**  
(Title 23 United States Code Section 112 and  
Public Contract Code Section 7106)

To the COUNTY OF HUMBOLDT, DEPARTMENT OF PUBLIC WORKS:

In conformance with Title 23 United States Code Section 112 and Public Contract Code 7106 the bidder declares that the bid is not made in the interest of, or on behalf of, any undisclosed person, partnership, company, association, organization, or corporation; that the bid is genuine and not collusive or sham; that the bidder has not directly or indirectly induced or solicited any other bidder to put in a false or sham bid, and has not directly or indirectly colluded, conspired, connived, or agreed with any bidder or anyone else to put in a sham bid, or that anyone shall refrain from bidding; that the bidder has not in any manner, directly or indirectly, sought by agreement, communication, or conference with anyone to fix the bid price of the bidder or any other bidder, or to fix any overhead, profit, or cost element of the bid price, or of that of any other bidder, or to secure any advantage against the public body awarding the contract of anyone interested in the proposed contract; that all statements contained in the bid are true; and, further, that the bidder has not, directly or indirectly, submitted his or her bid price or any breakdown thereof, or the contents thereof, or divulged information or data relative thereto, or paid, and will not pay, any fee to any corporation, partnership, company association, organization, bid depository, or to any member or agent thereof to effectuate a collusive or sham bid.

Note: The above Noncollusion Affidavit is part of the Proposal. Signing this Proposal on the signature portion thereof shall also constitute signature of this Noncollusion Affidavit.  
Bidders are cautioned that making a false certification may subject the certifier to criminal prosecution.

## NONLOBBYING CERTIFICATION FOR FEDERAL-AID CONTRACTS

The prospective participant certifies, by signing and submitting this bid or proposal, to the best of his or her knowledge and belief, that:

- (1) No Federal appropriated funds have been paid or will be paid, by or on behalf of the undersigned, to any person for influencing or attempting to influence an officer or employee of any Federal agency, a Member of Congress, an officer or employee of Congress, or an employee of a Member of Congress in connection with the awarding of any Federal contract, the making of any Federal grant, the making of any Federal loan, the entering into of any cooperative agreement, and the extension, continuation, renewal, amendment, or modification of any Federal contract, grant, loan, or cooperative agreement.
- (2) If any funds other than Federal appropriated funds have been paid or will be paid to any person for influencing or attempting to influence an officer or employee of any Federal agency, a Member of Congress, an officer or employee of Congress, or an employee of a Member of Congress in connection with this Federal contract, grant, loan, or cooperative agreement, the undersigned shall complete and submit Standard Form-LLL, "Disclosure of Lobbying Activities," in conformance with its instructions.

This certification is a material representation of fact upon which reliance was placed when this transaction was made or entered into. Submission of this certification is a prerequisite for making or entering into this transaction imposed by Section 1352, Title 31, U.S. Code. Any person who fails to file the required certification shall be subject to a civil penalty of not less than \$10,000 and not more than \$100,000 for each such failure.

The prospective participant also agrees by submitting his or her bid or proposal that he or she shall require that the language of this certification be included in all lower tier subcontracts, which exceed \$100,000 and that all such subrecipients shall certify and disclose accordingly.

### DISCLOSURE OF LOBBYING ACTIVITIES

Complete this form to disclose lobbying activities pursuant to 31 U.S.C. 1352

#### 1. Type of Federal Action:

- a. contract
- b. grant
- c. cooperative agreement
- d. loan
- e. loan guarantee
- f. loan insurance

#### 2. Status of Federal Action:

- a. bid/offer/application
- b. initial award
- c. post-award

#### 3. Report Type:

- a. initial
- b. material change

#### For Material Change Only:

year \_\_\_\_\_ quarter \_\_\_\_\_  
date of last report \_\_\_\_\_

#### 4. Name and Address of Reporting Entity

- Prime
- Subawardee  
Tier \_\_\_\_\_, if known

Congressional District, if known

#### 6. Federal Department/Agency:

#### 5. If Reporting Entity in No. 4 is Subawardee, Enter Name and Address of Prime:

Congressional District, if known

#### 7. Federal Program Name/Description:

CFDA Number, if applicable \_\_\_\_\_

#### 8. Federal Action Number, if known:

#### 9. Award Amount, if known:

#### 10. a. Name and Address of Lobby Entity (If individual, last name, first name, MI)

#### b. Individuals Performing Services (including address if different from No. 10a) (last name, first name, MI)

(attach Continuation Sheet(s) if necessary)

#### 11. Amount of Payment (check all that apply)

\$ \_\_\_\_\_  actual  planned

#### 13. Type of Payment (check all that apply)

- a. retainer
- b. one-time fee
- c. commission
- d. contingent fee
- e. deferred
- f. other, specify \_\_\_\_\_

#### 12. Form of Payment (check all that apply):

- a. cash
- b. in-kind; specify: nature \_\_\_\_\_  
value \_\_\_\_\_

#### 14. Brief Description of Services Performed or to be performed and Date(s) of Service, including officer(s), employee(s), or member(s) contacted, for Payment Indicated in Item 11:

(attach Continuation Sheet(s) if necessary)

#### 15. Continuation Sheet(s) attached: Yes No

16. Information requested through this form is authorized by Title 31 U.S.C. Section 1352. This disclosure of lobbying reliance was placed by the tier above when his transaction was made or entered into. This disclosure is required pursuant to 31 U.S.C. 1352. This information will be reported to Congress semiannually and will be available for public inspection. Any person who fails to file the required disclosure shall be subject to a civil penalty of not less than \$10,000 and not more than \$100,000 for each such failure.

Signature: \_\_\_\_\_

Print Name: \_\_\_\_\_

Title: \_\_\_\_\_

Telephone No.: \_\_\_\_\_ Date: \_\_\_\_\_

**Federal Use Only:**

Authorized for Local Reproduction  
Standard Form - LLL

## INSTRUCTIONS FOR COMPLETION OF SF-LLL, DISCLOSURE OF LOBBYING ACTIVITIES

This disclosure form shall be completed by the reporting entity, whether subawardee or prime Federal recipient, at the initiation or receipt of covered Federal action or a material change to previous filing pursuant to title 31 U.S.C. section 1352. The filing of a form is required for such payment or agreement to make payment to lobbying entity for influencing or attempting to influence an officer or employee of any agency, a Member of Congress an officer or employee of Congress or an employee of a Member of Congress in connection with a covered Federal action. Attach a continuation sheet for additional information if the space on the form is inadequate. Complete all items that apply for both the initial filing and material change report. Refer to the implementing guidance published by the Office of Management and Budget for additional information.

1. Identify the type of covered Federal action for which lobbying activity is and/or has been secured to influence, the outcome of a covered Federal action.
2. Identify the status of the covered Federal action.
3. Identify the appropriate classification of this report. If this is a follow-up report caused by a material change to the information previously reported, enter the year and quarter in which the change occurred. Enter the date of the last, previously submitted report by this reporting entity for this covered Federal action.
4. Enter the full name, address, city, state and zip code of the reporting entity. Include Congressional District if known. Check the appropriate classification of the reporting entity that designates if it is or expects to be a prime or subaward recipient. Identify the tier of the subawardee, e.g., the first subawardee of the prime is the first tier. Subawards include but are not limited to subcontracts, subgrants and contract awards under grants.
5. If the organization filing the report in Item 4 checks "Subawardee" then enter the full name, address, city, state and zip code of the prime Federal recipient. Include Congressional District, if known.
6. Enter the name of the Federal agency making the award or loan commitment. Include at least one organization level below agency name, if known. For example, Department of Transportation, United States Coast Guard.
7. Enter the Federal program name or description for the covered Federal action (item 1). If known, enter the full Catalog of Federal Domestic Assistance (CFDA) number for grants, cooperative agreements, loans, and loan commitments.
8. Enter the most appropriate Federal identifying number available for the Federal action identification in item 1 (e.g., Request for Proposal (RFP) number, Invitation for Bid (IFB) number, grant announcement number, the contract grant. or loan award number, the application/proposal control number assigned by the Federal agency). Include prefixes, e.g., "RFP-DE-90-001."
9. For a covered Federal action where there has been an award or loan commitment by the Federal agency, enter the Federal amount of the award/loan commitments for the prime entity identified in item 4 or 5.
10. (a) Enter the full name, address, city, state and zip code of the lobbying entity engaged by the reporting entity identified in item 4 to influenced the covered Federal action.  
(b) Enter the full names of the individual(s) performing services and include full address if different from 10 (a). Enter Last Name, First Name and Middle Initial (MI).
11. Enter the amount of compensation paid or reasonably expected to be paid by the reporting entity (item 4) to the lobbying entity (item 10). Indicate whether the payment has been made (actual) or will be made (planned). Check all boxes that apply. If this is a material change report, enter the cumulative amount of payment made or planned to be made.
12. Check the appropriate box(es). Check all boxes that apply. If payment is made through an in-kind contribution, specify the nature and value of the in-kind payment.
13. Check the appropriate box(es). Check all boxes that apply. If other, specify nature.
14. Provide a specific and detailed description of the services that the lobbyist has performed or will be expected to perform and the date(s) of any services rendered. Include all preparatory and related activity not just time spent in actual contact with Federal officials. Identify the Federal officer(s) or employee(s) contacted or the officer(s) employee(s) or Member(s) of Congress that were contacted.
15. Check whether or not a continuation sheet(s) is attached.
16. The certifying official shall sign and date the form, print his/her name title and telephone number.

Public reporting burden for this collection of information is estimated to average 30 minutes per response, including time for reviewing instruction, searching existing data sources, gathering and maintaining the data needed, and completing and reviewing the collection of information. Send comments regarding the burden estimate or any other aspect of this collection of information, including suggestions for reducing this burden, to the Office of Management and Budget, Paperwork Reduction Project (0348-0046), Washington, D.C. 20503.

**EXHIBIT 12-B: BIDDER'S LIST OF SUBCONTRACTORS (DBE AND NON-DBE) PART 1**

**ER-32L0(329) & ER-32L0(330) CONTRACT NO.: 217288 & 217294**

As of March 1, 2015, Contractors (and sub-contractors) wishing to bid on public works contracts shall be registered with the State Division of Industrial Relations and certified to bid on Public Works contracts. Please register at: <https://www.dir.ca.gov/Public-Works/Contractor-Registration.html>

In accordance with Title 49, Section 26.11 of the Code of Federal Regulations, and Section 4104 of the Public Contract Code of the State of California, as amended, the following information is required for each sub-contractor who will perform work amounting to more than one half of one percent (0.5%) of the Total Base Bid or \$10,000 (whichever is greater). **Photocopy this form for additional firms.** Federal Project Number:

Subcontractor Name and Location	Line Item & Description	Subcontract Amount	Percentage of Bid Item Sub-contracted	Contractor License Number	DBE (Y/N)	DBE Cert Number	Annual Gross Receipts	
				DIR Reg Number				
Name:								<\$1 million
City, State:								<\$5 million
								<\$10 million
								<\$15 million
								Age of Firm: ___ yrs.
Name:								<\$1 million
City, State:								<\$5 million
								<\$10 million
								<\$15 million
								Age of Firm: ___ yrs.
Name:								<\$1 million
City, State:								<\$5 million
								<\$10 million
								<\$15 million
								Age of Firm: ___ yrs.
Name:								<\$1 million
City, State:								<\$5 million
								<\$10 million
								<\$15 million
								Age of Firm: ___ yrs.
Name:								<\$1 million
City, State:								<\$5 million
								<\$10 million
								<\$15 million
								Age of Firm: ___ yrs.
Name:								<\$1 million
City, State:								<\$5 million
								<\$10 million
								<\$15 million
								Age of Firm: ___ yrs.

Distribution: Original-Local Agency File

**EXHIBIT 12-B: BIDDER'S LIST OF SUBCONTRACTORS (DBE AND NON-DBE) PART 2**  
**ER-32L0(329) & ER-32L0(330) CONTRACT NO.: 217288 & 217294**

In accordance with Title 49, Section 26 of the Code of Federal Regulations, the bidder shall list all subcontractors who provided a quote or bid, but **were not selected** to participate as a subcontractor on this project. **Photocopy this form for additional firms.** Federal Project Number: BPMP 5904(141)

Subcontractor Name and Location	Line Item & Description	Subcontract Amount	Percentage of Bid Item Sub-contracted	Contractor License Number	DBE (Y/N)	DBE Cert Number	Annual Gross Receipts	
				DIR Reg Number				
Name:								<\$1 million
City, State:								<\$5 million
								<\$10 million
								<\$15 million
								Age of Firm: ___ yrs.
Name:								<\$1 million
City, State:								<\$5 million
								<\$10 million
								<\$15 million
								Age of Firm: ___ yrs.
Name:								<\$1 million
City, State:								<\$5 million
								<\$10 million
								<\$15 million
								Age of Firm: ___ yrs.
Name:								<\$1 million
City, State:								<\$5 million
								<\$10 million
								<\$15 million
								Age of Firm: ___ yrs.
Name:								<\$1 million
City, State:								<\$5 million
								<\$10 million
								<\$15 million
								Age of Firm: ___ yrs.
Name:								<\$1 million
City, State:								<\$5 million
								<\$10 million
								<\$15 million
								Age of Firm: ___ yrs.

Distribution: Original-Local Agency File



**EXHIBIT 15-G CONSTRUCTION CONTRACT DBE COMMITMENT**

1. Local Agency: \_\_\_\_\_ 2. Contract DBE Goal: \_\_\_\_\_  
 3. Project Description: \_\_\_\_\_  
 4. Project Location: \_\_\_\_\_  
 5. Bidder's Name: \_\_\_\_\_ 6. Prime Certified DBE:  7. Bid Amount: \_\_\_\_\_  
 8. Total Dollar Amount for **ALL** Subcontractors: \_\_\_\_\_ 9. Total Number of **ALL** Subcontractors: \_\_\_\_\_

10. Bid Item Number	11. Description of Work, Service, or Materials Supplied	12. DBE Certification Number	13. DBE Contact Information (Must be certified on the date bids are opened)	14. DBE Dollar Amount
<b>Local Agency to Complete this Section upon Execution of Award</b>				
21. Local Agency Contract Number: _____				<b>15. TOTAL CLAIMED DBE PARTICIPATION</b>
22. Federal-Aid Project Number: _____				
23. Bid Opening Date: _____				%
24. Contract Award Date: _____				
25. Award Amount: _____				<p><b>IMPORTANT:</b> Identify all DBE firms being claimed for credit, regardless of tier. Names of the First Tier DBE Subcontractors and their respective item(s) of work listed above must be consistent, where applicable with the names and items of the work in the "Subcontractor List" submitted with your bid. Written confirmation of each listed DBE is required.</p>
26. Local Agency Representative's Signature _____		27. Date _____		
28. Local Agency Representative's Name _____		29. Phone _____		
30. Local Agency Representative's Title _____				
16. Preparer's Signature _____		17. Date _____		
18. Preparer's Name _____		19. Phone _____		
20. Preparer's Title _____				

**DISTRIBUTION:** 1. Original – Local Agency Updated January 2019  
 2. Copy – Caltrans District Local Assistance Engineer (DLAE). Failure to submit to DLAE within 30 days of contract execution may result in de-obligation of federal funds on contract.  
 3. Include additional copy with award package.

**ADA Notice:** For individuals with sensory disabilities, this document is available in alternate formats. For information call (916) 654-6410 or TDD (916) 654-3880 or write Records and Forms Management, 1120 N Street, MS-89, Sacramento, CA 95814.

## INSTRUCTIONS – CONSTRUCTION CONTRACT DBE COMMITMENT

### CONTRACTOR SECTION

- 1. Local Agency** - Enter the name of the local agency that is administering the contract.
- 2. Contract DBE Goal** - Enter the contract DBE goal percentage as it appears on the project advertisement.
- 3. Project Location** - Enter the project location(s) as it appears on the project advertisement.
- 4. Project Description** - Enter the project description as it appears on the project advertisement (Bridge Rehab, Seismic Rehab, Overlay, Widening, etc).
- 5. Bidder's Name** - Enter the contractor's firm name.
- 6. Prime Certified DBE** - Check box if prime contractor is a certified DBE.
- 7. Bid Amount** - Enter the total contract bid dollar amount for the prime contractor.
- 8. Total Dollar Amount for ALL Subcontractors** – Enter the total dollar amount for all subcontracted contractors. SUM = (DBEs + all Non-DBEs). Do not include the prime contractor information in this count.
- 9. Total number of ALL subcontractors** – Enter the total number of all subcontracted contractors. SUM = (DBEs + all Non-DBEs). Do not include the prime contractor information in this count.
- 10. Bid Item Number** - Enter bid item number for work, services, or materials supplied to be provided.
- 11. Description of Work, Services, or Materials Supplied** - Enter description of work, services, or materials to be provided. Indicate all work to be performed by DBEs including work performed by the prime contractor's own forces, if the prime is a DBE. If 100% of the item is not to be performed or furnished by the DBE, describe the exact portion to be performed or furnished by the DBE. See LAPM Chapter 9 to determine how to count the participation of DBE firms.
- 12. DBE Certification Number** - Enter the DBE's Certification Identification Number. All DBEs must be certified on the date bids are opened.
- 13. DBE Contact Information** - Enter the name, address, and phone number of all DBE subcontracted contractors. Also, enter the prime contractor's name and phone number, if the prime is a DBE.
- 14. DBE Dollar Amount** - Enter the subcontracted dollar amount of the work to be performed or service to be provided. Include the prime contractor if the prime is a DBE. See LAPM Chapter 9 for how to count full/partial participation.
- 15. Total Claimed DBE Participation** - \$: Enter the total dollar amounts entered in the "DBE Dollar Amount" column. %: Enter the total DBE participation claimed ("Total Claimed DBE Participation Dollars" divided by item "Bid Amount"). If the total % claimed is less than item "Contract DBE Goal," an adequately documented Good Faith Effort (GFE) is required (see Exhibit 15-H DBE Information - Good Faith Efforts of the LAPM).
- 16. Preparer's Signature** - The person completing the DBE commitment form on behalf of the contractor's firm must sign their name.
- 17. Date** - Enter the date the DBE commitment form is signed by the contractor's preparer.
- 18. Preparer's Name** - Enter the name of the person preparing and signing the contractor's DBE commitment form.
- 19. Phone** - Enter the area code and phone number of the person signing the contractor's DBE commitment form.
- 20. Preparer's Title** - Enter the position/title of the person signing the contractor's DBE commitment form.

### LOCAL AGENCY SECTION

- 21. Local Agency Contract Number** - Enter the Local Agency contract number or identifier.
- 22. Federal-Aid Project Number** - Enter the Federal-Aid Project Number(s).
- 23. Bid Opening Date** - Enter the date contract bids were opened.
- 24. Contract Award Date** - Enter the date the contract was executed.
- 25. Award Amount** – Enter the contract award amount as stated in the executed contract.

**26. Local Agency Representative's Signature** - The person completing this section of the form for the Local Agency must sign their name to certify that the information in this and the Contractor Section of this form is complete and accurate.

**27. Date** - Enter the date the DBE commitment form is signed by the Local Agency Representative.

**28. Local Agency Representative's Name** - Enter the name of the Local Agency Representative certifying the contractor's DBE commitment form.

**29. Phone** - Enter the area code and phone number of the person signing the contractor's DBE commitment form.

**30. Local Agency Representative Title** - Enter the position/title of the Local Agency Representative certifying the contractor's DBE commitment form.

**EXHIBIT 15-H: CONTRACTOR GOOD FAITH EFFORTS**Federal-aid Project No. **ER-32L0(329) & ER-32L0(330)**Bid Opening Date **MAY 4, 2021**

The County of Humboldt established a Disadvantaged Business Enterprise (DBE) goal of **8%** for this contract. The information provided herein shows the required good faith efforts to meet or exceed the DBE contract goal.

Bidders submit the following information to document their good faith efforts within five (5) business days from bid opening. Bidders are recommended to submit the following information even if the Exhibit 15-G: Construction Contract DBE Commitment indicate that the bidder has met the DBE goal. This form protects the bidder's eligibility for award of the contract if the administering agency determines that the bidder failed to meet the goal for various reasons, e.g., a DBE firm was not certified at bid opening, or the bidder made a mathematical error.

The following items are listed in the Section entitled "Submission of DBE Commitment" of the Special Provisions, **please attach additional sheets as needed:**

- A. The names and dates of each publication in which a request for DBE participation for this project was placed by the bidder (please attach copies of advertisements or proofs of publication):

Publications

Dates of Advertisement

---



---



---



---

- B. The names and dates of written notices sent to certified DBEs soliciting bids for this project and the dates and methods used for following up initial solicitations to determine with certainty whether the DBEs were interested (please attach copies of solicitations, telephone records, fax confirmations, etc.):

Names of DBEs Solicited

Date of Initial Solicitation

Follow Up Methods and Dates

---



---



---



---



---



---



---



---

C. The items of work made available to DBE firms including those unbundled contract work items into economically feasible units to facilitate DBE participation. It is the bidder's responsibility to demonstrate that sufficient work to facilitate DBE participation in order to meet or exceed the DBE contract goal.

Items of Work	Bidder Normally Performs Item (Y/N)	Breakdown of Items	Amount (\$)	Percentage Of Contract
---------------	-------------------------------------	--------------------	-------------	------------------------

---



---



---



---

D. The names, addresses and phone numbers of rejected DBE firms, the reasons for the bidder's rejection of the DBEs, the firms selected for that work (please attach copies of quotes from the firms involved), and the price difference for each DBE if the selected firm is not a DBE:

Names, addresses and phone numbers of rejected DBEs and the reasons for the bidder's rejection of the DBEs:

---



---



---



---

Names, addresses and phone numbers of firms selected for the work above:

---



---



---



---

E. Efforts (e.g. in advertisements and solicitations) made to assist interested DBEs in obtaining information related to the plans, specifications and requirements for the work which was provided to DBEs:

---



---



---



---

F. Efforts (e.g. in advertisements and solicitations) made to assist interested DBEs in obtaining bonding, lines of credit or insurance, necessary equipment, supplies, materials, or related assistance or services, excluding supplies and equipment the DBE subcontractor purchases or leases from the prime contractor or its affiliate:

---

---

---

---

---

G. The names of agencies, organizations or groups contacted to provide assistance in contacting, recruiting and using DBE firms (please attach copies of requests to agencies and any responses received, i.e., lists, Internet page download, etc.):

Name of Agency/Organization	Method/Date of Contact	Results
-----------------------------	------------------------	---------

H. Any additional data to support a demonstration of good faith efforts:

---

---

---

---

---

---

---

---

---

---

---

---

---

---

---

---

---

---

---

### EXHIBIT 9-F: DISADVANTAGED BUSINESS ENTERPRISE (DBE) RUNNING TALLY OF PAYMENTS

Save this form using the following naming convention, [yyyymm]-[Prime's DUNS Number]-[ss].xlsx. [ss] is two digit sequential numbering, applicable when consultant or contractor has more than one 9-F form to complete per pay period. For example, a valid saved file could read: 202001-123456789-01.xlsx. Prime contractors/consultants are required to submit this form no later than the 10<sup>th</sup> of the following month, after submitting an invoice for reimbursement that includes a payment to a DBE. If no payments have been made, do not submit the form. Email this form to [Business.Support.Unit@dot.ca.gov](mailto:Business.Support.Unit@dot.ca.gov) with a copy to their local administering agencies.

**Do not submit this form with the invoice, it will not be processed.**

(1) Reporting Period (mm-yyyy)	(2) Federal Aid Project Number		(3) Caltrans District			(4) Local Agency	
(5) Contract Number	(6) Total Contract Award Amount (\$)		(7) DBE Goal Percentage (%)			(8) DBE Committed Percentage (%)	
(9) Prime Contractor/Consultant DUNS Number	(10) Business Name		(11) Amount Prime Invoiced This Period (\$)			(12) Amount Paid to Prime To Date (\$)	(13) Prime Certified DBE?
(14) DBE Subcontractor/Subconsultant Name	(15) DBE Cert. Number	(16) Contract Type	(17) Date of Payment	(18) Amount of This Payment	(19) Amount Paid To Date	(20) Amount Committed To This DBE	(21) Comments
			Totals	\$0	\$0	\$0	

List all DBEs regardless of tier, whether or not the firms were originally listed in Exhibit 10-Q2 or 15-G as a DBE commitment. If the actual DBE utilization was different than that approved at the time of award, provide comments in box (21). All payments reported, including payments to contractor/consultant, are for the date listed. Select the most appropriate contract type (Agent, Consultant, Joint Venture, Manufacturer, Prime, Regular Dealer, Subcontractor, Truck/Haul, Service Provider) for the DBE from dropdown list.

By executing this 9-F, Contractor/Consultant represents and warrants, under penalty of perjury, that:  
 Contractor/Consultant contracted with the Disadvantaged Business Enterprise companies (DBEs) as set forth in their awarded bid on Contract number \_\_\_\_\_  
 Contractor/Consultant paid the full amounts listed on their 9-F to the DBEs set forth in Contractor's awarded bid, without reduction or offset.

(22) Prime Contractor/Consultant Manager's Name (Print)	(23) Business Phone Number	(24) Date

COPY DISTRIBUTION: Original - Prime Contractor/Consultant, Copy - E-mail: [Business.Support.Unit@dot.ca.gov](mailto:Business.Support.Unit@dot.ca.gov); Copy: Local Administering Agency

ADA NOTICE: For individuals with sensory disabilities, this document is available in alternate formats.  
 For information, call (916) 445-1233, Local Assistance Procedures Manual TTY 711, or write to Records and Forms Management, 1120 N Street, MS-89, Sacramento, CA 95814.

## Exhibit 9-F Instructions

### I. Purpose:

Title 49 of the Code of Federal Regulations (CFR), Part 26.37(c) requires recipients of federal-aid funding to “provide a running tally of actual attainments, including a means of comparing these attainments to commitments.” This requirement does not apply to projects that do not have any federal funding.

### II. Policy:

A. To comply with 49 CFR 26.37(c), the prime contractors/consultants must complete the Exhibit 9-F: Disadvantaged Business Enterprise Running Tally of Payments and email it to [business.support.unit@dot.ca.gov](mailto:business.support.unit@dot.ca.gov) and their local administering agencies after submitting an invoice for reimbursement that includes a payment to a DBE, but no later than the 10th of the following month. Submission of this Exhibit is required until all DBE subcontracting or material supply activity on the entire project is completed.

B. Save this form using the following naming convention, [yyyymm]-[Prime's DUNS Number]-[ss].xlsx. [ss] is two digit sequential numbering, applicable when consultant or contractor has more than one 9-F form to complete per pay period. For example, a valid saved file could read: 202001-123456789-01.xlsx

### III. Instructions:

- (1) **Reporting Period (mm-yyyy):** Indicate the month and year of payments being reported.
  - (2) **Federal Aid Project Number:** Enter the 7 digit federal-aid project number of the lead project on the contract. E.g. 5002(123) is a valid Federal-Aid Project Number.
  - (3) **Caltrans District:** Enter the appropriate Caltrans District number as 1 through 12.
  - (4) **Local Agency:** List the local agency's name.
  - (5) **Contract Number:** List the local agency assigned contract agreement number.
  - (6) **Total Contract Award Amount (\$):** Enter the total current contract award amount of the project.
  - (7) **DBE Goal Percentage (%):** Enter the contract DBE goal percentage as it appears on the project advertisement.
  - (8) **DBE Committed Percentage (%):** Enter percentage of the Prime contract committed to DBE firms.
  - (9) **Prime Contractor/Consultant DUNS Number:** Enter the unique nine-digit Data Universal Numbering System (DUNS) that Contractors/Consultants should have in order to participate in Federally-funded contracts.
  - (10) **Business Name:** List the name for the prime contractor/consultant as identified in Procedure 9 above.
  - (11) **Amount Prime's Invoice This Period (\$):** Enter the total invoice amount that prime submitted for reimbursement this period.
  - (12) **Amount Paid to Prime To Date (\$):** Enter the total payment that is paid to the Prime to date.
  - (13) **Prime certified DBE:** Enter "Yes" if Prime Contractor/Consultant is certified DBE and "No" otherwise.  
DBE Prime contractor needs to fill in from procedure (14) to (21) for payments to DBE Subcontractors and DBE Prime's self-performing.
- Note:** For Procedures (14) through (21) below, insert rows as needed to list all DBEs included on Exhibits 10-O2 or 15-G, and any other DBEs that were utilized regardless of tier.
- (14) **DBE Firm name:** List the DBE's firm name.
  - (15) **DBE Cert. Number:** List the DBE's certification number as listed in the California Unified Certification Program (CUCP) database.
  - (16) **Contract Type:** Select the most appropriate Subcontractor's contract type (Agent, Consultant, Joint Venture, Manufacturer, Prime, Regular Dealer, Subcontractor, Truck/Haul, Service Provider from dropdown list.)
  - (17) **Date of Payment:** List current check date when a check is issued to the DBE for work performed by the DBE.
  - (18) **Amount of This Payment:** List the total amount paid to the DBE this period.
  - (19) **Amount Paid to Date:** List the total amount paid to this DBE to date. This should be a total of past payments plus payment for the current work just invoiced to the Local Agency.
  - (20) **Amount Committed to This DBE Firm:** Copy the information from the agency signed Exhibit 10-O2 or 15-G. If the listed DBE was not originally committed to, type "0."
  - (21) **Comments:** Add appropriate notes if a DBE subcontract was terminated, a DBE subcontract was added, if change orders impacted the DBE's payments (include good faith efforts the prime contractor/consultant implemented), if task orders weren't issued, etc.
  - (22) **Prime Contractor/Consultant Manager's Name:** Enter the manager's name of the prime contractor/consultant of the project.
  - (23) **Business Phone Number:** Enter the manager's business phone number of the prime contractor/consultant.
  - (24) **Date:** Provide the date this form was prepared.
  - (25) **Copy Distribution:** The prime contractor/consultant will need to maintain a copy with the contract file (electronic and/or paper). The prime contractor/consultant will need to e-mail this form as provided in the Section II. Policy, paragraphs A as stated above. Local agency will need to keep a copy with the contract file.



**EXHIBIT 17-F FINAL REPORT-UTILIZATION OF DBE AND FIRST-TIER SUBCONTRACTORS**

1. Local Agency Contract Number <b>CONTRACT NO.: 217288 &amp; 217294</b>		2. Federal-Aid Project Number <b>ER-32L0(329) &amp; ER-32L0(330)</b>		3. Local Agency <b>HUMBOLDT COUNTY</b>			4. Contract Completion Date	
5. Contractor/Consultant			6. Business Address			7. Final Contract Amount		
8. Contract Item Number	9. Description of Work, Service, or Materials Supplied	10. Company Name and Business Address	11. DBE Certification Number	12. Contract Payments		13. Date Work Completed	14. Date of Final Payment	
				Non-DBE	DBE			
15. ORIGINAL DBE COMMITMENT AMOUNT      \$ _____				16. TOTAL				

List all first-tier subcontractors/subconsultants and DBEs regardless of tier whether or not the firms were originally listed for goal credit. If actual DBE utilization (or item of work) was different than that approved at the time of award, provide comments on an additional page. List actual amount paid to each entity. If no subcontractors/subconsultants were used on the contract, indicate on the form.

<b>I CERTIFY THAT THE ABOVE INFORMATION IS COMPLETE AND CORRECT</b>			
17. Contractor/Consultant Representative's Signature	18. Contractor/Consultant Representative's Name	19. Phone	20. Date
<b>I CERTIFY THAT THE CONTRACTING RECORDS AND ON-SITE PERFORMANCE OF THE DBE(S) HAS BEEN MONITORED</b>			
21. Local Agency Representative's Signature	22. Local Agency Representative's Name	23. Phone	24. Date

DISTRIBUTION: Original – Local Agency, Copy – Caltrans District Local Assistance Engineer. Include with Final Report of Expenditures

ADA NOTICE: For individuals with sensory disabilities, this document is available in alternate formats. For information, call (916) 445-1233, Local Assistance Procedures Manual TTY 711, or write to Records and Forms Management, 1120 N Street, MS-89, Sacramento, CA 95814.

## INSTRUCTIONS – FINAL REPORT-UTILIZATION OF DISADVANTAGED BUSINESS ENTERPRISES (DBE) AND FIRST-TIER SUBCONTRACTORS

1. **Local Agency Contract Number** - Enter the Local Agency contract number or identifier.
2. **Federal-Aid Project Number** - Enter the Federal-Aid Project Number.
3. **Local Agency** - Enter the name of the local or regional agency that is funding the contract.
4. **Contract Completion Date** - Enter the date the contract was completed.
5. **Contractor/Consultant** - Enter the contractor/consultant's firm name.
6. **Business Address** - Enter the contractor/consultant's business address.
7. **Final Contract Amount** - Enter the total final amount for the contract.
8. **Contract Item Number** - Enter contract item for work, services, or materials supplied provided. Not applicable for consultant contracts.
9. **Description of Work, Services, or Materials Supplied** - Enter description of work, services, or materials provided. Indicate all work to be performed by DBEs including work performed by the prime contractor/consultant's own forces, if the prime is a DBE. If 100% of the item is not to be performed or furnished by the DBE, describe the exact portion to be performed or furnished by the DBE. See LAPM Chapter 9 to determine how to count the participation of DBE firms.
10. **Company Name and Business Address** - Enter the name, address, and phone number of all subcontracted contractors/consultants. Also, enter the prime contractor/consultant's name and phone number, if the prime is a DBE.
11. **DBE Certification Number** - Enter the DBE's Certification Identification Number. Leave blank if subcontractor is not a DBE.
12. **Contract Payments** - Enter the subcontracted dollar amount of the work performed or service provided. Include the prime contractor/consultant if the prime is a DBE. The Non-DBE column is used to enter the dollar value of work performed by firms that are not certified DBE or for work after a DBE becomes decertified.
13. **Date Work Completed** - Enter the date the subcontractor/subconsultant's item work was completed.
14. **Date of Final Payment** - Enter the date when the prime contractor/consultant made the final payment to the subcontractor/subconsultant for the portion of work listed as being completed.
15. **Original DBE Commitment Amount** - Enter the "Total Claimed DBE Participation Dollars" from Exhibits 15-G or 10-O2 for the contract.
16. **Total** - Enter the sum of the "Contract Payments" Non-DBE and DBE columns.
17. **Contractor/Consultant Representative's Signature** - The person completing the form on behalf of the contractor/consultant's firm must sign their name.
18. **Contractor/Consultant Representative's Name** - Enter the name of the person preparing and signing the form.
19. **Phone** - Enter the area code and telephone number of the person signing the form.
20. **Date** - Enter the date the form is signed by the contractor's preparer.
21. **Local Agency Representative's Signature** - A Local Agency Representative must sign their name to certify that the contracting records and on-site performance of the DBE(s) has been monitored.
22. **Local Agency Representative's Name** - Enter the name of the Local Agency Representative signing the form.
23. **Phone** - Enter the area code and telephone number of the person signing the form.
24. **Date** - Enter the date the form is signed by the Local Agency Representative.

**EXHIBIT 17-O: DBE CERTIFICATION STATUS CHANGE**

1. Local Agency Contract Number <b>CONTRACT NO.: 217288 &amp; 217294</b>		2. Federal-Aid Project Number <b>ER-32L0(329) &amp; ER-32L0(330)</b>		3. Local Agency <b>HUMBOLDT COUNTY</b>		4. Contract Completion Date
5. Contractor/Consultant			6. Business Address			7. Final Contract Amount
8. Contract Item Number	9. DBE Contact Information	10. DBE Certification Number	11. Amount Paid While Certified	12. Certification/Decertification Date (Letter Attached)	13. Comments	

If there were no changes in the DBE certification of subcontractors/subconsultants, indicate on the form.

<b>I CERTIFY THAT THE ABOVE INFORMATION IS COMPLETE AND CORRECT</b>			
14. Contractor/Consultant Representative's Signature	15. Contractor/Consultant Representative's Name	16. Phone	17. Date
<b>I CERTIFY THAT THE CONTRACTING RECORDS AND ON-SITE PERFORMANCE OF THE DBE(S) HAS BEEN MONITORED</b>			
18. Local Agency Representative's Signature	19. Local Agency Representative's Name	20. Phone	21. Date

DISTRIBUTION: Original – Local Agency, Copy – Caltrans District Local Assistance Engineer. Include with Final Report of Expenditures

ADA NOTICE: For individuals with sensory disabilities, this document is available in alternate formats. For information, call (916) 445-1233, Local Assistance Procedures Manual TTY 711, or write to Records and Forms Management, 1120 N Street, MS-89, Sacramento, CA 95814.

**INSTRUCTIONS –DISADVANTAGED BUSINESS ENTERPRISES (DBE)  
CERTIFICATION STATUS CHANGE**

1. **Local Agency Contract Number** - Enter the Local Agency contract number or identifier.
2. **Federal-Aid Project Number** - Enter the Federal-Aid Project Number.
3. **Local Agency** - Enter the name of the local or regional agency that is funding the contract.
4. **Contract Completion Date** - Enter the date the contract was completed.
5. **Contractor/Consultant** - Enter the contractor/consultant's firm name.
6. **Business Address** - Enter the contractor/consultant's business address.
7. **Final Contract Amount** - Enter the total final amount for the contract.
8. **Contract Item Number** - Enter contract item for work, services, or materials supplied provided. Not applicable for consultant contracts.
9. **DBE Contact Information** - Enter the name, address, and phone number of all DBE subcontracted contractors/consultants.
10. **DBE Certification Number** - Enter the DBE's Certification Identification Number.
11. **Amount Paid While Certified** - Enter the actual dollar value of the work performed by those subcontractors/subconsultants during the time period they are certified as a DBE.
12. **Certification/Decertification Date (Letter Attached)** - Enter either the date of the Decertification Letter sent out by the Office of Business and Economic Opportunity (OBEO) or the date of the Certification Certificate mailed out by OBEO.
13. **Comments** - If needed, provide any additional information in this section regarding any of the above certification status changes.
14. **Contractor/Consultant Representative's Signature** - The person completing the form on behalf of the contractor/consultant's firm must sign their name.
15. **Contractor/Consultant Representative's Name** - Enter the name of the person preparing and signing the form.
16. **Phone** - Enter the area code and telephone number of the person signing the form.
17. **Date** - Enter the date the form is signed by the contractor's preparer.
18. **Local Agency Representative's Signature** - A Local Agency Representative must sign their name to certify that the contracting records and on-site performance of the DBE(s) has been monitored.
19. **Local Agency Representative's Name** - Enter the name of the Local Agency Representative signing the form.
20. **Phone** - Enter the area code and telephone number of the person signing the form.
21. **Date** - Enter the date the form is signed by the Local Agency Representative.

## AGREEMENT

This is an AGREEMENT made and entered into this \_\_\_\_\_ day  
of \_\_\_\_\_, 20\_\_\_\_\_, by and between the County of Humboldt, a  
political subdivision of the State of California (hereinafter referred to as COUNTY)  
and \_\_\_\_\_,  
a corporation organized and existing under the laws of the State of \_\_\_\_\_;  
a partnership consisting of \_\_\_\_\_  
\_\_\_\_\_  
an individual doing business as \_\_\_\_\_  
\_\_\_\_\_ in the State of California,  
hereinafter referred to as "CONTRACTOR".

### Section 1 - SCOPE OF WORK

Contractor shall furnish all Labor, Tools and Materials and perform all the work for the:

**STORM DAMAGE REPAIRS TO ALDERPOINT ROAD  
(F6B165)  
AT PM 21.8, 22.8, 23.0-23.05 & 23.75  
ER-32L0(329) & ER-32L0(330)  
CONTRACT NO.: 217288 & 217294**

in accordance with the contract documents referred to in Section 3 of this Agreement.

### Section 2 - CONTRACT PRICE

County shall pay, and Contractor shall accept Contractor's Bid Prices, as shown on EXHIBIT "A" attached hereto and made a part hereof, as full compensation for furnishing all materials and for doing all the work contemplated and embraced in this Agreement; also for all loss or damage, arising out of the work aforesaid, or from the actions of the elements, or from any unforeseen difficulties or obstructions which may arise or be encountered in the prosecution of the work until its acceptance by County, and for all risks of every description connected with the work; also for all expenses incurred by or in consequence of the suspension or discontinuance of the work and for well and faithfully completing the work, and the whole thereof, in the manner and according to the Plans and Specifications, and the requirements of the Engineer.

### **Section 3 - CONTRACT DOCUMENTS**

The complete contract between the parties hereto shall consist of the following, hereinafter referred to as the CONTRACT DOCUMENTS:

- Notice to Bidders
- Plans and Drawings
- Bid Form
- Bidder's Bond
- Supplemental Project Information
- Performance Bond
- Payment Bond
- This Agreement
- Special Provisions

And, as published by the Department of Transportation, State of California, except as modified by the Special Provisions:

- Standard Plans - dated 2018
- Revised Standard Plans – dated 04-17-2020
- Standard Specifications - dated 2018
- Revised Standard Specifications Dated 04-17-2020
- Equipment Rental Rates in effect at the time the work is performed

And, as published by the California Department of Industrial Relations, and the California Business, Transportation and Housing Agency:

- General Prevailing Wage Rates
- Labor and Surcharge Rates

And any addenda to any of the above documents, all of which are on file in the office of the Director of Public Works of the County of Humboldt. Each of said CONTRACT DOCUMENTS is incorporated and made a part of this Agreement by the reference contained in this Section.

All rights and obligations of the County and the Contractor are fully set forth and described in the Contract Documents. All of the above named documents are intended to be complimentary, so that any work called for in one, and mentioned in the other is to be performed and executed the same as if mentioned in all said documents.

### **Section 4 - BEGINNING OF WORK**

Following receipt and full execution and approval of the Contract Documents, and posting of the requisite Bonds as called for therein, the COUNTY will issue a "Notice to Proceed". Under no circumstances shall the CONTRACTOR enter upon the site of work until receipt of the "Notice to Proceed", or unless so authorized in writing by the COUNTY.

**Section 5 - TIME OF COMPLETION**

The work called for in this Agreement shall be commenced within fifty-five (55) days of receipt of Notice to Proceed by COUNTY and shall be fully completed within a period of 120 working days beginning on the fifty-fifth calendar day after the date of said approval of contract.

**Section 6 - PREVAILING WAGE**

Copies of the prevailing wage rates of per diem wages are on file in the Humboldt County Public Works office at 1106 Second Street, Eureka, California and are available to any interested person on request.

**Section 7 - WORKERS' COMPENSATION**

By my signature hereunder, as CONTRACTOR, I certify that I am aware of the provisions of Section 3700 of the Labor Code which requires every employer to be insured against liability for Workers' Compensation or to undertake self insurance in accordance with the provisions of that code, and I will comply with such provisions before commencing the performance of the work of this contract.

**Section 8 - COMPLIANCE WITH LAWS**

The Contractor agrees to comply with all local, state, and federal laws and regulations, including but not limited to the Americans With Disabilities Act. The Contractor further agrees to comply with any applicable federal, state or local licensing standards, any applicable accrediting standards, and any other applicable standards or criteria established locally or by the state or federal governments.

This agreement shall be governed by and construed in accordance with the laws of the State of California.

**Section 9 - NOTICES**

All notices shall be in writing and delivered in person or transmitted by mail. Notices required to be given to the COUNTY shall be addressed as follows:

Humboldt County Department of Public Works  
1106 Second Street, Eureka, California, 95501

Notices required to be given to CONTRACTOR shall be addressed as follows:

---

---

---

---

IN WITNESS WHEREOF, The parties hereto have entered into this Agreement as of the date first above set forth.

COUNTY OF HUMBOLDT

(SEAL) BY \_\_\_\_\_  
Chair, Board of Supervisors  
of the County of Humboldt,  
State of California

ATTEST:

KATHY HAYES  
Clerk of the Board of Supervisors  
of the County of Humboldt,  
State of California

BY \_\_\_\_\_  
Clerk of the Board

CONTRACTOR

BY \_\_\_\_\_

TITLE \_\_\_\_\_

BY \_\_\_\_\_

TITLE \_\_\_\_\_

(Two Signatures Required For Corporation)

APPROVED AS TO FORM:

BY \_\_\_\_\_  
Deputy County Counsel

INSURANCE CERTIFICATES REVIEWED  
AND APPROVED:

BY \_\_\_\_\_  
Risk Manager



**PAYMENT BOND**

KNOW ALL MEN BY THESE PRESENTS:

THAT WHEREAS, the County of Humboldt, by its order made \_\_\_\_\_, 20\_\_\_\_, has awarded to \_\_\_\_\_ hereinafter designated as the "Principal," a contract for the work described as follows:

**STORM DAMAGE REPAIRS TO ALDERPOINT ROAD (F6B165)  
AT PM 21.8, 22.8, 23.0-23.05 & 23.75**

NOW, THEREFORE, we the Principal and \_\_\_\_\_, Surety, are held and firmly bound unto the County of Humboldt in the penal sum of \_\_\_\_\_ Dollars (\$ \_\_\_\_\_), lawful money of the United States of America for the payment of which sum well and truly to be made, we bind ourselves, our heirs, executors, administrators, successors and assigns, jointly and severally, firmly by these presents.

THE CONDITION OF THIS OBLIGATION IS SUCH that if said Principal, his or its subcontractors, heirs, executors, administrators, successors, or assigns, shall fail to pay any of the persons named in Section 3181 of the Civil Code, or amounts due under the Unemployment Insurance Code, with respect to work or labor performed by claimant, or for any amounts required to be deducted, withheld, and paid over to the Franchise Tax Board from the wages of employees of the Contractor and his subcontractors pursuant to Section 18806 of the Revenue and Taxation Code with respect to such work and labor as required by Sections 3247 et seq. of the Civil Code of California, then said Surety will pay for the same, in or to an amount not exceeding the amount hereinafter set forth, and also will pay in case suit is brought upon this bond, such reasonable attorney's fees, as shall be fixed by the court, awarded and taxed as in the above-mentioned statutes provided.

AND, the said Surety, for value received, hereby stipulates and agrees that no change, extension of time, alteration or addition to the terms of the contract or to the work to be performed thereunder or the specifications accompanying the same shall in any way affect its obligations on this bond, and it does hereby waive notice of any such change, extension of time, alteration or addition to the terms of the contract, or to the work, or to the specifications.

IN WITNESS WHEREOF, this instrument has been duly executed by Principal and Surety above named, on the \_\_\_\_\_ day of \_\_\_\_\_, 20\_\_\_\_.

\_\_\_\_\_  
PRINCIPAL  
BY \_\_\_\_\_

\_\_\_\_\_  
SURETY  
BY \_\_\_\_\_  
Attorney-in-fact

**PERFORMANCE BOND**

COUNTY OF HUMBOLDT, DEPARTMENT OF PUBLIC WORKS

Bond No. \_\_\_\_\_

**WHEREAS**, the County of Humboldt, acting by and through the Department of Public Works, has awarded to Contractor \_\_\_\_\_, hereafter designated as the "Contractor", a contract for the work described as follows:

**STORM DAMAGE REPAIRS TO ALDERPOINT ROAD (F6B165)  
AT PM 21.8, 22.8, 23.0-23.05 & 23.75**

**AND WHEREAS**, the Contractor is required to furnish a bond in connection with said contract, guaranteeing the faithful performance thereof:

**NOW, THEREFORE**, we the undersigned Contractor and Surety are held firmly bound to the County of Humboldt in the sum of \$ \_\_\_\_\_ dollars (\$ \_\_\_\_\_), to be paid to said County or its certain attorney, its successors and assigns: for which payment, well and truly to be made, we bind ourselves, our heirs, executors and administrators, successors or assigns, jointly and severally, firmly by these presents.

**THE CONDITION OF THIS OBLIGATION IS SUCH,**

That if the above bound Contractor, its heirs, executors, administrators, successors or assigns, shall in all things stand to and abide by, and well and truly keep and perform the covenants, conditions and agreements in the foregoing contract and any alteration thereof made as therein provided, on his or their part to be kept and performed at the time and in the manner therein specified, and in all respects according to their intent and meaning, and shall indemnify and save harmless the County of Humboldt, its officers and agents, as therein stipulated, then this obligation shall become and be null and void; otherwise it shall be and remain in full force and virtue.

**IN WITNESS WHEREOF**, We have hereunto set our hands and seals on this \_\_\_\_\_ day of \_\_\_\_\_, 20\_\_.

Correspondence or claim relating to this bond should be sent to the surety at the following address:

\_\_\_\_\_  
\_\_\_\_\_  
\_\_\_\_\_

\_\_\_\_\_  
\_\_\_\_\_  
\_\_\_\_\_  
Contractor

\_\_\_\_\_  
Name of Surety (SEAL)

\_\_\_\_\_  
By: Attorney-in-Fact

NOTE: Signatures of those executing for the surety must be properly acknowledged.

**CERTIFICATE OF ACKNOWLEDGEMENT**

State of California, City / County of \_\_\_\_\_ SS

On this \_\_\_\_\_ day of \_\_\_\_\_ in the year 20\_\_\_\_ before me \_\_\_\_\_, a  
Notary public in and for the City / County of \_\_\_\_\_, personally appeared  
\_\_\_\_\_, known to me to be the person whose name is subscribed to this  
*Attorney-in-fact*  
instrument and known to me to be the attorney-in-fact of \_\_\_\_\_ and acknowledge to  
me that he/she subscribed the name of the said company thereto as surety, and his/her own name as attorney-in-  
fact.

(SEAL)

\_\_\_\_\_  
**NOTARY PUBLIC**

**REQUIRED CONTRACT PROVISIONS  
FEDERAL-AID CONSTRUCTION CONTRACTS**

- I. General
- II. Nondiscrimination
- III. Nonsegregated Facilities
- IV. Davis-Bacon and Related Act Provisions
- V. Contract Work Hours and Safety Standards Act Provisions
- VI. Subletting or Assigning the Contract
- VII. Safety: Accident Prevention
- VIII. False Statements Concerning Highway Projects
- IX. Implementation of Clean Air Act and Federal Water Pollution Control Act
- X. Compliance with Governmentwide Suspension and Debarment Requirements
- XI. Certification Regarding Use of Contract Funds for Lobbying

**ATTACHMENTS**

A. Employment and Materials Preference for Appalachian Development Highway System or Appalachian Local Access Road Contracts (included in Appalachian contracts only)

**I. GENERAL**

1. Form FHWA-1273 must be physically incorporated in each construction contract funded under Title 23 (excluding emergency contracts solely intended for debris removal). The contractor (or subcontractor) must insert this form in each subcontract and further require its inclusion in all lower tier subcontracts (excluding purchase orders, rental agreements and other agreements for supplies or services).

The applicable requirements of Form FHWA-1273 are incorporated by reference for work done under any purchase order, rental agreement or agreement for other services. The prime contractor shall be responsible for compliance by any subcontractor, lower-tier subcontractor or service provider.

Form FHWA-1273 must be included in all Federal-aid design-build contracts, in all subcontracts and in lower tier subcontracts (excluding subcontracts for design services, purchase orders, rental agreements and other agreements for supplies or services). The design-builder shall be responsible for compliance by any subcontractor, lower-tier subcontractor or service provider.

Contracting agencies may reference Form FHWA-1273 in bid proposal or request for proposal documents, however, the Form FHWA-1273 must be physically incorporated (not referenced) in all contracts, subcontracts and lower-tier subcontracts (excluding purchase orders, rental agreements and other agreements for supplies or services related to a construction contract).

2. Subject to the applicability criteria noted in the following sections, these contract provisions shall apply to all work performed on the contract by the contractor's own organization and with the assistance of workers under the contractor's immediate superintendence and to all work performed on the contract by piecework, station work, or by subcontract.

3. A breach of any of the stipulations contained in these Required Contract Provisions may be sufficient grounds for withholding of progress payments, withholding of final payment, termination of the contract, suspension / debarment or any other action determined to be appropriate by the contracting agency and FHWA.

4. Selection of Labor: During the performance of this contract, the contractor shall not use convict labor for any purpose within the limits of a construction project on a Federal-aid highway unless it is labor performed by convicts who are on parole, supervised release, or probation. The term Federal-aid highway does not include roadways functionally classified as local roads or rural minor collectors.

**II. NONDISCRIMINATION**

The provisions of this section related to 23 CFR Part 230 are applicable to all Federal-aid construction contracts and to all related construction subcontracts of \$10,000 or more. The provisions of 23 CFR Part 230 are not applicable to material supply, engineering, or architectural service contracts.

In addition, the contractor and all subcontractors must comply with the following policies: Executive Order 11246, 41 CFR 60, 29 CFR 1625-1627, Title 23 USC Section 140, the Rehabilitation Act of 1973, as amended (29 USC 794), Title VI of the Civil Rights Act of 1964, as amended, and related regulations including 49 CFR Parts 21, 26 and 27; and 23 CFR Parts 200, 230, and 633.

The contractor and all subcontractors must comply with: the requirements of the Equal Opportunity Clause in 41 CFR 60-1.4(b) and, for all construction contracts exceeding \$10,000, the Standard Federal Equal Employment Opportunity Construction Contract Specifications in 41 CFR 60-4.3.

Note: The U.S. Department of Labor has exclusive authority to determine compliance with Executive Order 11246 and the policies of the Secretary of Labor including 41 CFR 60, and 29 CFR 1625-1627. The contracting agency and the FHWA have the authority and the responsibility to ensure compliance with Title 23 USC Section 140, the Rehabilitation Act of 1973, as amended (29 USC 794), and Title VI of the Civil Rights Act of 1964, as amended, and related regulations including 49 CFR Parts 21, 26 and 27; and 23 CFR Parts 200, 230, and 633.

The following provision is adopted from 23 CFR 230, Appendix A, with appropriate revisions to conform to the U.S. Department of Labor (US DOL) and FHWA requirements.

**1. Equal Employment Opportunity:** Equal employment opportunity (EEO) requirements not to discriminate and to take affirmative action to assure equal opportunity as set forth under laws, executive orders, rules, regulations (28 CFR 35, 29 CFR 1630, 29 CFR 1625-1627, 41 CFR 60 and 49 CFR 27) and orders of the Secretary of Labor as modified by the provisions prescribed herein, and imposed pursuant to 23 U.S.C. 140 shall constitute the EEO and specific affirmative action standards for the contractor's project activities under

this contract. The provisions of the Americans with Disabilities Act of 1990 (42 U.S.C. 12101 et seq.) set forth under 28 CFR 35 and 29 CFR 1630 are incorporated by reference in this contract. In the execution of this contract, the contractor agrees to comply with the following minimum specific requirement activities of EEO:

a. The contractor will work with the contracting agency and the Federal Government to ensure that it has made every good faith effort to provide equal opportunity with respect to all of its terms and conditions of employment and in their review of activities under the contract.

b. The contractor will accept as its operating policy the following statement:

"It is the policy of this Company to assure that applicants are employed, and that employees are treated during employment, without regard to their race, religion, sex, color, national origin, age or disability. Such action shall include: employment, upgrading, demotion, or transfer; recruitment or recruitment advertising; layoff or termination; rates of pay or other forms of compensation; and selection for training, including apprenticeship, pre-apprenticeship, and/or on-the-job training."

**2. EEO Officer:** The contractor will designate and make known to the contracting officers an EEO Officer who will have the responsibility for and must be capable of effectively administering and promoting an active EEO program and who must be assigned adequate authority and responsibility to do so.

**3. Dissemination of Policy:** All members of the contractor's staff who are authorized to hire, supervise, promote, and discharge employees, or who recommend such action, or who are substantially involved in such action, will be made fully cognizant of, and will implement, the contractor's EEO policy and contractual responsibilities to provide EEO in each grade and classification of employment. To ensure that the above agreement will be met, the following actions will be taken as a minimum:

a. Periodic meetings of supervisory and personnel office employees will be conducted before the start of work and then not less often than once every six months, at which time the contractor's EEO policy and its implementation will be reviewed and explained. The meetings will be conducted by the EEO Officer.

b. All new supervisory or personnel office employees will be given a thorough indoctrination by the EEO Officer, covering all major aspects of the contractor's EEO obligations within thirty days following their reporting for duty with the contractor.

c. All personnel who are engaged in direct recruitment for the project will be instructed by the EEO Officer in the contractor's procedures for locating and hiring minorities and women.

d. Notices and posters setting forth the contractor's EEO policy will be placed in areas readily accessible to employees, applicants for employment and potential employees.

e. The contractor's EEO policy and the procedures to implement such policy will be brought to the attention of employees by means of meetings, employee handbooks, or other appropriate means.

**4. Recruitment:** When advertising for employees, the contractor will include in all advertisements for employees the notation: "An Equal Opportunity Employer." All such advertisements will be placed in publications having a large circulation among minorities and women in the area from which the project work force would normally be derived.

a. The contractor will, unless precluded by a valid bargaining agreement, conduct systematic and direct recruitment through public and private employee referral sources likely to yield qualified minorities and women. To meet this requirement, the contractor will identify sources of potential minority group employees, and establish with such identified sources procedures whereby minority and women applicants may be referred to the contractor for employment consideration.

b. In the event the contractor has a valid bargaining agreement providing for exclusive hiring hall referrals, the contractor is expected to observe the provisions of that agreement to the extent that the system meets the contractor's compliance with EEO contract provisions. Where implementation of such an agreement has the effect of discriminating against minorities or women, or obligates the contractor to do the same, such implementation violates Federal nondiscrimination provisions.

c. The contractor will encourage its present employees to refer minorities and women as applicants for employment. Information and procedures with regard to referring such applicants will be discussed with employees.

**5. Personnel Actions:** Wages, working conditions, and employee benefits shall be established and administered, and personnel actions of every type, including hiring, upgrading, promotion, transfer, demotion, layoff, and termination, shall be taken without regard to race, color, religion, sex, national origin, age or disability. The following procedures shall be followed:

a. The contractor will conduct periodic inspections of project sites to insure that working conditions and employee facilities do not indicate discriminatory treatment of project site personnel.

b. The contractor will periodically evaluate the spread of wages paid within each classification to determine any evidence of discriminatory wage practices.

c. The contractor will periodically review selected personnel actions in depth to determine whether there is evidence of discrimination. Where evidence is found, the contractor will promptly take corrective action. If the review indicates that the discrimination may extend beyond the actions reviewed, such corrective action shall include all affected persons.

d. The contractor will promptly investigate all complaints of alleged discrimination made to the contractor in connection with its obligations under this contract, will attempt to resolve such complaints, and will take appropriate corrective action within a reasonable time. If the investigation indicates that the discrimination may affect persons other than the complainant, such corrective action shall include such other persons. Upon completion of each investigation, the contractor will inform every complainant of all of their avenues of appeal.

**6. Training and Promotion:**

a. The contractor will assist in locating, qualifying, and increasing the skills of minorities and women who are

applicants for employment or current employees. Such efforts should be aimed at developing full journey level status employees in the type of trade or job classification involved.

b. Consistent with the contractor's work force requirements and as permissible under Federal and State regulations, the contractor shall make full use of training programs, i.e., apprenticeship, and on-the-job training programs for the geographical area of contract performance. In the event a special provision for training is provided under this contract, this subparagraph will be superseded as indicated in the special provision. The contracting agency may reserve training positions for persons who receive welfare assistance in accordance with 23 U.S.C. 140(a).

c. The contractor will advise employees and applicants for employment of available training programs and entrance requirements for each.

d. The contractor will periodically review the training and promotion potential of employees who are minorities and women and will encourage eligible employees to apply for such training and promotion.

**7. Unions:** If the contractor relies in whole or in part upon unions as a source of employees, the contractor will use good faith efforts to obtain the cooperation of such unions to increase opportunities for minorities and women. Actions by the contractor, either directly or through a contractor's association acting as agent, will include the procedures set forth below:

a. The contractor will use good faith efforts to develop, in cooperation with the unions, joint training programs aimed toward qualifying more minorities and women for membership in the unions and increasing the skills of minorities and women so that they may qualify for higher paying employment.

b. The contractor will use good faith efforts to incorporate an EEO clause into each union agreement to the end that such union will be contractually bound to refer applicants without regard to their race, color, religion, sex, national origin, age or disability.

c. The contractor is to obtain information as to the referral practices and policies of the labor union except that to the extent such information is within the exclusive possession of the labor union and such labor union refuses to furnish such information to the contractor, the contractor shall so certify to the contracting agency and shall set forth what efforts have been made to obtain such information.

d. In the event the union is unable to provide the contractor with a reasonable flow of referrals within the time limit set forth in the collective bargaining agreement, the contractor will, through independent recruitment efforts, fill the employment vacancies without regard to race, color, religion, sex, national origin, age or disability; making full efforts to obtain qualified and/or qualifiable minorities and women. The failure of a union to provide sufficient referrals (even though it is obligated to provide exclusive referrals under the terms of a collective bargaining agreement) does not relieve the contractor from the requirements of this paragraph. In the event the union referral practice prevents the contractor from meeting the obligations pursuant to Executive Order 11246, as amended, and these special provisions, such contractor shall immediately notify the contracting agency.

**8. Reasonable Accommodation for Applicants / Employees with Disabilities:** The contractor must be familiar

with the requirements for and comply with the Americans with Disabilities Act and all rules and regulations established there under. Employers must provide reasonable accommodation in all employment activities unless to do so would cause an undue hardship.

**9. Selection of Subcontractors, Procurement of Materials and Leasing of Equipment:** The contractor shall not discriminate on the grounds of race, color, religion, sex, national origin, age or disability in the selection and retention of subcontractors, including procurement of materials and leases of equipment. The contractor shall take all necessary and reasonable steps to ensure nondiscrimination in the administration of this contract.

a. The contractor shall notify all potential subcontractors and suppliers and lessors of their EEO obligations under this contract.

b. The contractor will use good faith efforts to ensure subcontractor compliance with their EEO obligations.

**10. Assurance Required by 49 CFR 26.13(b):**

a. The requirements of 49 CFR Part 26 and the State DOT's U.S. DOT-approved DBE program are incorporated by reference.

b. The contractor or subcontractor shall not discriminate on the basis of race, color, national origin, or sex in the performance of this contract. The contractor shall carry out applicable requirements of 49 CFR Part 26 in the award and administration of DOT-assisted contracts. Failure by the contractor to carry out these requirements is a material breach of this contract, which may result in the termination of this contract or such other remedy as the contracting agency deems appropriate.

**11. Records and Reports:** The contractor shall keep such records as necessary to document compliance with the EEO requirements. Such records shall be retained for a period of three years following the date of the final payment to the contractor for all contract work and shall be available at reasonable times and places for inspection by authorized representatives of the contracting agency and the FHWA.

a. The records kept by the contractor shall document the following:

(1) The number and work hours of minority and non-minority group members and women employed in each work classification on the project;

(2) The progress and efforts being made in cooperation with unions, when applicable, to increase employment opportunities for minorities and women; and

(3) The progress and efforts being made in locating, hiring, training, qualifying, and upgrading minorities and women;

b. The contractors and subcontractors will submit an annual report to the contracting agency each July for the duration of the project, indicating the number of minority, women, and non-minority group employees currently engaged in each work classification required by the contract work. This information is to be reported on [Form FHWA-1391](#). The staffing data should represent the project work force on board in all or any part of the last payroll period preceding the end of July. If on-the-job training is being required by special provision, the contractor

will be required to collect and report training data. The employment data should reflect the work force on board during all or any part of the last payroll period preceding the end of July.

### III. NONSEGREGATED FACILITIES

This provision is applicable to all Federal-aid construction contracts and to all related construction subcontracts of \$10,000 or more.

The contractor must ensure that facilities provided for employees are provided in such a manner that segregation on the basis of race, color, religion, sex, or national origin cannot result. The contractor may neither require such segregated use by written or oral policies nor tolerate such use by employee custom. The contractor's obligation extends further to ensure that its employees are not assigned to perform their services at any location, under the contractor's control, where the facilities are segregated. The term "facilities" includes waiting rooms, work areas, restaurants and other eating areas, time clocks, restrooms, washrooms, locker rooms, and other storage or dressing areas, parking lots, drinking fountains, recreation or entertainment areas, transportation, and housing provided for employees. The contractor shall provide separate or single-user restrooms and necessary dressing or sleeping areas to assure privacy between sexes.

### IV. DAVIS-BACON AND RELATED ACT PROVISIONS

This section is applicable to all Federal-aid construction projects exceeding \$2,000 and to all related subcontracts and lower-tier subcontracts (regardless of subcontract size). The requirements apply to all projects located within the right-of-way of a roadway that is functionally classified as Federal-aid highway. This excludes roadways functionally classified as local roads or rural minor collectors, which are exempt. Contracting agencies may elect to apply these requirements to other projects.

The following provisions are from the U.S. Department of Labor regulations in 29 CFR 5.5 "Contract provisions and related matters" with minor revisions to conform to the FHWA-1273 format and FHWA program requirements.

#### 1. Minimum wages

a. All laborers and mechanics employed or working upon the site of the work, will be paid unconditionally and not less often than once a week, and without subsequent deduction or rebate on any account (except such payroll deductions as are permitted by regulations issued by the Secretary of Labor under the Copeland Act (29 CFR part 3)), the full amount of wages and bona fide fringe benefits (or cash equivalents thereof) due at time of payment computed at rates not less than those contained in the wage determination of the Secretary of Labor which is attached hereto and made a part hereof, regardless of any contractual relationship which may be alleged to exist between the contractor and such laborers and mechanics.

Contributions made or costs reasonably anticipated for bona fide fringe benefits under section 1(b)(2) of the Davis-Bacon Act on behalf of laborers or mechanics are considered wages paid to such laborers or mechanics, subject to the provisions

of paragraph 1.d. of this section; also, regular contributions made or costs incurred for more than a weekly period (but not less often than quarterly) under plans, funds, or programs which cover the particular weekly period, are deemed to be constructively made or incurred during such weekly period. Such laborers and mechanics shall be paid the appropriate wage rate and fringe benefits on the wage determination for the classification of work actually performed, without regard to skill, except as provided in 29 CFR 5.5(a)(4). Laborers or mechanics performing work in more than one classification may be compensated at the rate specified for each classification for the time actually worked therein: Provided, That the employer's payroll records accurately set forth the time spent in each classification in which work is performed. The wage determination (including any additional classification and wage rates conformed under paragraph 1.b. of this section) and the Davis-Bacon poster (WH-1321) shall be posted at all times by the contractor and its subcontractors at the site of the work in a prominent and accessible place where it can be easily seen by the workers.

b. (1) The contracting officer shall require that any class of laborers or mechanics, including helpers, which is not listed in the wage determination and which is to be employed under the contract shall be classified in conformance with the wage determination. The contracting officer shall approve an additional classification and wage rate and fringe benefits therefore only when the following criteria have been met:

(i) The work to be performed by the classification requested is not performed by a classification in the wage determination; and

(ii) The classification is utilized in the area by the construction industry; and

(iii) The proposed wage rate, including any bona fide fringe benefits, bears a reasonable relationship to the wage rates contained in the wage determination.

(2) If the contractor and the laborers and mechanics to be employed in the classification (if known), or their representatives, and the contracting officer agree on the classification and wage rate (including the amount designated for fringe benefits where appropriate), a report of the action taken shall be sent by the contracting officer to the Administrator of the Wage and Hour Division, Employment Standards Administration, U.S. Department of Labor, Washington, DC 20210. The Administrator, or an authorized representative, will approve, modify, or disapprove every additional classification action within 30 days of receipt and so advise the contracting officer or will notify the contracting officer within the 30-day period that additional time is necessary.

(3) In the event the contractor, the laborers or mechanics to be employed in the classification or their representatives, and the contracting officer do not agree on the proposed classification and wage rate (including the amount designated for fringe benefits, where appropriate), the contracting officer shall refer the questions, including the views of all interested parties and the recommendation of the contracting officer, to the Wage and Hour Administrator for determination. The Wage and Hour Administrator, or an authorized representative, will issue a determination within 30 days of receipt and so advise the contracting officer or

will notify the contracting officer within the 30-day period that additional time is necessary.

(4) The wage rate (including fringe benefits where appropriate) determined pursuant to paragraphs 1.b.(2) or 1.b.(3) of this section, shall be paid to all workers performing work in the classification under this contract from the first day on which work is performed in the classification.

c. Whenever the minimum wage rate prescribed in the contract for a class of laborers or mechanics includes a fringe benefit which is not expressed as an hourly rate, the contractor shall either pay the benefit as stated in the wage determination or shall pay another bona fide fringe benefit or an hourly cash equivalent thereof.

d. If the contractor does not make payments to a trustee or other third person, the contractor may consider as part of the wages of any laborer or mechanic the amount of any costs reasonably anticipated in providing bona fide fringe benefits under a plan or program. Provided, That the Secretary of Labor has found, upon the written request of the contractor, that the applicable standards of the Davis-Bacon Act have been met. The Secretary of Labor may require the contractor to set aside in a separate account assets for the meeting of obligations under the plan or program.

## 2. Withholding

The contracting agency shall upon its own action or upon written request of an authorized representative of the Department of Labor, withhold or cause to be withheld from the contractor under this contract, or any other Federal contract with the same prime contractor, or any other federally-assisted contract subject to Davis-Bacon prevailing wage requirements, which is held by the same prime contractor, so much of the accrued payments or advances as may be considered necessary to pay laborers and mechanics, including apprentices, trainees, and helpers, employed by the contractor or any subcontractor the full amount of wages required by the contract. In the event of failure to pay any laborer or mechanic, including any apprentice, trainee, or helper, employed or working on the site of the work, all or part of the wages required by the contract, the contracting agency may, after written notice to the contractor, take such action as may be necessary to cause the suspension of any further payment, advance, or guarantee of funds until such violations have ceased.

## 3. Payrolls and basic records

a. Payrolls and basic records relating thereto shall be maintained by the contractor during the course of the work and preserved for a period of three years thereafter for all laborers and mechanics working at the site of the work. Such records shall contain the name, address, and social security number of each such worker, his or her correct classification, hourly rates of wages paid (including rates of contributions or costs anticipated for bona fide fringe benefits or cash equivalents thereof of the types described in section 1(b)(2)(B) of the Davis-Bacon Act), daily and weekly number of hours worked, deductions made and actual wages paid. Whenever the Secretary of Labor has found under 29 CFR 5.5(a)(1)(iv) that the wages of any laborer or mechanic include the amount of any costs reasonably anticipated in providing benefits under a plan or program described in section 1(b)(2)(B) of the Davis-

Bacon Act, the contractor shall maintain records which show that the commitment to provide such benefits is enforceable, that the plan or program is financially responsible, and that the plan or program has been communicated in writing to the laborers or mechanics affected, and records which show the costs anticipated or the actual cost incurred in providing such benefits. Contractors employing apprentices or trainees under approved programs shall maintain written evidence of the registration of apprenticeship programs and certification of trainee programs, the registration of the apprentices and trainees, and the ratios and wage rates prescribed in the applicable programs.

b.(1) The contractor shall submit weekly for each week in which any contract work is performed a copy of all payrolls to the contracting agency. The payrolls submitted shall set out accurately and completely all of the information required to be maintained under 29 CFR 5.5(a)(3)(i), except that full social security numbers and home addresses shall not be included on weekly transmittals. Instead the payrolls shall only need to include an individually identifying number for each employee (e.g., the last four digits of the employee's social security number). The required weekly payroll information may be submitted in any form desired. Optional Form WH-347 is available for this purpose from the Wage and Hour Division Web site at <http://www.dol.gov/esa/whd/forms/wh347instr.htm> or its successor site. The prime contractor is responsible for the submission of copies of payrolls by all subcontractors. Contractors and subcontractors shall maintain the full social security number and current address of each covered worker, and shall provide them upon request to the contracting agency for transmission to the State DOT, the FHWA or the Wage and Hour Division of the Department of Labor for purposes of an investigation or audit of compliance with prevailing wage requirements. It is not a violation of this section for a prime contractor to require a subcontractor to provide addresses and social security numbers to the prime contractor for its own records, without weekly submission to the contracting agency..

(2) Each payroll submitted shall be accompanied by a "Statement of Compliance," signed by the contractor or subcontractor or his or her agent who pays or supervises the payment of the persons employed under the contract and shall certify the following:

(i) That the payroll for the payroll period contains the information required to be provided under §5.5 (a)(3)(ii) of Regulations, 29 CFR part 5, the appropriate information is being maintained under §5.5 (a)(3)(i) of Regulations, 29 CFR part 5, and that such information is correct and complete;

(ii) That each laborer or mechanic (including each helper, apprentice, and trainee) employed on the contract during the payroll period has been paid the full weekly wages earned, without rebate, either directly or indirectly, and that no deductions have been made either directly or indirectly from the full wages earned, other than permissible deductions as set forth in Regulations, 29 CFR part 3;

(iii) That each laborer or mechanic has been paid not less than the applicable wage rates and fringe benefits or cash equivalents for the classification of work performed, as specified in the applicable wage determination incorporated into the contract.



(3) The weekly submission of a properly executed certification set forth on the reverse side of Optional Form WH-347 shall satisfy the requirement for submission of the "Statement of Compliance" required by paragraph 3.b.(2) of this section.

(4) The falsification of any of the above certifications may subject the contractor or subcontractor to civil or criminal prosecution under section 1001 of title 18 and section 231 of title 31 of the United States Code.

c. The contractor or subcontractor shall make the records required under paragraph 3.a. of this section available for inspection, copying, or transcription by authorized representatives of the contracting agency, the State DOT, the FHWA, or the Department of Labor, and shall permit such representatives to interview employees during working hours on the job. If the contractor or subcontractor fails to submit the required records or to make them available, the FHWA may, after written notice to the contractor, the contracting agency or the State DOT, take such action as may be necessary to cause the suspension of any further payment, advance, or guarantee of funds. Furthermore, failure to submit the required records upon request or to make such records available may be grounds for debarment action pursuant to 29 CFR 5.12.

#### 4. Apprentices and trainees

##### a. Apprentices (programs of the USDOL).

Apprentices will be permitted to work at less than the predetermined rate for the work they performed when they are employed pursuant to and individually registered in a bona fide apprenticeship program registered with the U.S. Department of Labor, Employment and Training Administration, Office of Apprenticeship Training, Employer and Labor Services, or with a State Apprenticeship Agency recognized by the Office, or if a person is employed in his or her first 90 days of probationary employment as an apprentice in such an apprenticeship program, who is not individually registered in the program, but who has been certified by the Office of Apprenticeship Training, Employer and Labor Services or a State Apprenticeship Agency (where appropriate) to be eligible for probationary employment as an apprentice.

The allowable ratio of apprentices to journeymen on the job site in any craft classification shall not be greater than the ratio permitted to the contractor as to the entire work force under the registered program. Any worker listed on a payroll at an apprentice wage rate, who is not registered or otherwise employed as stated above, shall be paid not less than the applicable wage rate on the wage determination for the classification of work actually performed. In addition, any apprentice performing work on the job site in excess of the ratio permitted under the registered program shall be paid not less than the applicable wage rate on the wage determination for the work actually performed. Where a contractor is performing construction on a project in a locality other than that in which its program is registered, the ratios and wage rates (expressed in percentages of the journeyman's hourly rate) specified in the contractor's or subcontractor's registered program shall be observed.

Every apprentice must be paid at not less than the rate specified in the registered program for the apprentice's level of progress, expressed as a percentage of the journeymen hourly

rate specified in the applicable wage determination. Apprentices shall be paid fringe benefits in accordance with the provisions of the apprenticeship program. If the apprenticeship program does not specify fringe benefits, apprentices must be paid the full amount of fringe benefits listed on the wage determination for the applicable classification. If the Administrator determines that a different practice prevails for the applicable apprentice classification, fringes shall be paid in accordance with that determination.

In the event the Office of Apprenticeship Training, Employer and Labor Services, or a State Apprenticeship Agency recognized by the Office, withdraws approval of an apprenticeship program, the contractor will no longer be permitted to utilize apprentices at less than the applicable predetermined rate for the work performed until an acceptable program is approved.

##### b. Trainees (programs of the USDOL).

Except as provided in 29 CFR 5.16, trainees will not be permitted to work at less than the predetermined rate for the work performed unless they are employed pursuant to and individually registered in a program which has received prior approval, evidenced by formal certification by the U.S. Department of Labor, Employment and Training Administration.

The ratio of trainees to journeymen on the job site shall not be greater than permitted under the plan approved by the Employment and Training Administration.

Every trainee must be paid at not less than the rate specified in the approved program for the trainee's level of progress, expressed as a percentage of the journeyman hourly rate specified in the applicable wage determination. Trainees shall be paid fringe benefits in accordance with the provisions of the trainee program. If the trainee program does not mention fringe benefits, trainees shall be paid the full amount of fringe benefits listed on the wage determination unless the Administrator of the Wage and Hour Division determines that there is an apprenticeship program associated with the corresponding journeyman wage rate on the wage determination which provides for less than full fringe benefits for apprentices. Any employee listed on the payroll at a trainee rate who is not registered and participating in a training plan approved by the Employment and Training Administration shall be paid not less than the applicable wage rate on the wage determination for the classification of work actually performed. In addition, any trainee performing work on the job site in excess of the ratio permitted under the registered program shall be paid not less than the applicable wage rate on the wage determination for the work actually performed.

In the event the Employment and Training Administration withdraws approval of a training program, the contractor will no longer be permitted to utilize trainees at less than the applicable predetermined rate for the work performed until an acceptable program is approved.

c. Equal employment opportunity. The utilization of apprentices, trainees and journeymen under this part shall be in conformity with the equal employment opportunity requirements of Executive Order 11246, as amended, and 29 CFR part 30.

d. Apprentices and Trainees (programs of the U.S. DOT).

Apprentices and trainees working under apprenticeship and skill training programs which have been certified by the Secretary of Transportation as promoting EEO in connection with Federal-aid highway construction programs are not subject to the requirements of paragraph 4 of this Section IV. The straight time hourly wage rates for apprentices and trainees under such programs will be established by the particular programs. The ratio of apprentices and trainees to journeymen shall not be greater than permitted by the terms of the particular program.

**5. Compliance with Copeland Act requirements.** The contractor shall comply with the requirements of 29 CFR part 3, which are incorporated by reference in this contract.

**6. Subcontracts.** The contractor or subcontractor shall insert Form FHWA-1273 in any subcontracts and also require the subcontractors to include Form FHWA-1273 in any lower tier subcontracts. The prime contractor shall be responsible for the compliance by any subcontractor or lower tier subcontractor with all the contract clauses in 29 CFR 5.5.

**7. Contract termination: debarment.** A breach of the contract clauses in 29 CFR 5.5 may be grounds for termination of the contract, and for debarment as a contractor and a subcontractor as provided in 29 CFR 5.12.

**8. Compliance with Davis-Bacon and Related Act requirements.** All rulings and interpretations of the Davis-Bacon and Related Acts contained in 29 CFR parts 1, 3, and 5 are herein incorporated by reference in this contract.

**9. Disputes concerning labor standards.** Disputes arising out of the labor standards provisions of this contract shall not be subject to the general disputes clause of this contract. Such disputes shall be resolved in accordance with the procedures of the Department of Labor set forth in 29 CFR parts 5, 6, and 7. Disputes within the meaning of this clause include disputes between the contractor (or any of its subcontractors) and the contracting agency, the U.S. Department of Labor, or the employees or their representatives.

**10. Certification of eligibility.**

a. By entering into this contract, the contractor certifies that neither it (nor he or she) nor any person or firm who has an interest in the contractor's firm is a person or firm ineligible to be awarded Government contracts by virtue of section 3(a) of the Davis-Bacon Act or 29 CFR 5.12(a)(1).

b. No part of this contract shall be subcontracted to any person or firm ineligible for award of a Government contract by virtue of section 3(a) of the Davis-Bacon Act or 29 CFR 5.12(a)(1).

c. The penalty for making false statements is prescribed in the U.S. Criminal Code, 18 U.S.C. 1001.

**V. CONTRACT WORK HOURS AND SAFETY STANDARDS ACT**

The following clauses apply to any Federal-aid construction contract in an amount in excess of \$100,000 and subject to the overtime provisions of the Contract Work Hours and Safety Standards Act. These clauses shall be inserted in addition to the clauses required by 29 CFR 5.5(a) or 29 CFR 4.6. As used in this paragraph, the terms laborers and mechanics include watchmen and guards.

**1. Overtime requirements.** No contractor or subcontractor contracting for any part of the contract work which may require or involve the employment of laborers or mechanics shall require or permit any such laborer or mechanic in any workweek in which he or she is employed on such work to work in excess of forty hours in such workweek unless such laborer or mechanic receives compensation at a rate not less than one and one-half times the basic rate of pay for all hours worked in excess of forty hours in such workweek.

**2. Violation; liability for unpaid wages; liquidated damages.** In the event of any violation of the clause set forth in paragraph (1.) of this section, the contractor and any subcontractor responsible therefor shall be liable for the unpaid wages. In addition, such contractor and subcontractor shall be liable to the United States (in the case of work done under contract for the District of Columbia or a territory, to such District or to such territory), for liquidated damages. Such liquidated damages shall be computed with respect to each individual laborer or mechanic, including watchmen and guards, employed in violation of the clause set forth in paragraph (1.) of this section, in the sum of \$10 for each calendar day on which such individual was required or permitted to work in excess of the standard workweek of forty hours without payment of the overtime wages required by the clause set forth in paragraph (1.) of this section.

**3. Withholding for unpaid wages and liquidated damages.** The FHWA or the contracting agency shall upon its own action or upon written request of an authorized representative of the Department of Labor withhold or cause to be withheld, from any moneys payable on account of work performed by the contractor or subcontractor under any such contract or any other Federal contract with the same prime contractor, or any other federally-assisted contract subject to the Contract Work Hours and Safety Standards Act, which is held by the same prime contractor, such sums as may be determined to be necessary to satisfy any liabilities of such contractor or subcontractor for unpaid wages and liquidated damages as provided in the clause set forth in paragraph (2.) of this section.

**4. Subcontracts.** The contractor or subcontractor shall insert in any subcontracts the clauses set forth in paragraph (1.) through (4.) of this section and also a clause requiring the subcontractors to include these clauses in any lower tier subcontracts. The prime contractor shall be responsible for compliance by any subcontractor or lower tier subcontractor with the clauses set forth in paragraphs (1.) through (4.) of this section.

## VI. SUBLETTING OR ASSIGNING THE CONTRACT

This provision is applicable to all Federal-aid construction contracts on the National Highway System.

1. The contractor shall perform with its own organization contract work amounting to not less than 30 percent (or a greater percentage if specified elsewhere in the contract) of the total original contract price, excluding any specialty items designated by the contracting agency. Specialty items may be performed by subcontract and the amount of any such specialty items performed may be deducted from the total original contract price before computing the amount of work required to be performed by the contractor's own organization (23 CFR 635.116).

a. The term "perform work with its own organization" refers to workers employed or leased by the prime contractor, and equipment owned or rented by the prime contractor, with or without operators. Such term does not include employees or equipment of a subcontractor or lower tier subcontractor, agents of the prime contractor, or any other assignees. The term may include payments for the costs of hiring leased employees from an employee leasing firm meeting all relevant Federal and State regulatory requirements. Leased employees may only be included in this term if the prime contractor meets all of the following conditions:

(1) the prime contractor maintains control over the supervision of the day-to-day activities of the leased employees;

(2) the prime contractor remains responsible for the quality of the work of the leased employees;

(3) the prime contractor retains all power to accept or exclude individual employees from work on the project; and

(4) the prime contractor remains ultimately responsible for the payment of predetermined minimum wages, the submission of payrolls, statements of compliance and all other Federal regulatory requirements.

b. "Specialty Items" shall be construed to be limited to work that requires highly specialized knowledge, abilities, or equipment not ordinarily available in the type of contracting organizations qualified and expected to bid or propose on the contract as a whole and in general are to be limited to minor components of the overall contract.

2. The contract amount upon which the requirements set forth in paragraph (1) of Section VI is computed includes the cost of material and manufactured products which are to be purchased or produced by the contractor under the contract provisions.

3. The contractor shall furnish (a) a competent superintendent or supervisor who is employed by the firm, has full authority to direct performance of the work in accordance with the contract requirements, and is in charge of all construction operations (regardless of who performs the work) and (b) such other of its own organizational resources (supervision, management, and engineering services) as the contracting officer determines is necessary to assure the performance of the contract.

4. No portion of the contract shall be sublet, assigned or otherwise disposed of except with the written consent of the contracting officer, or authorized representative, and such consent when given shall not be construed to relieve the contractor of any responsibility for the fulfillment of the contract. Written consent will be given only after the contracting agency has assured that each subcontract is

evidenced in writing and that it contains all pertinent provisions and requirements of the prime contract.

5. The 30% self-performance requirement of paragraph (1) is not applicable to design-build contracts; however, contracting agencies may establish their own self-performance requirements.

## VII. SAFETY: ACCIDENT PREVENTION

This provision is applicable to all Federal-aid construction contracts and to all related subcontracts.

1. In the performance of this contract the contractor shall comply with all applicable Federal, State, and local laws governing safety, health, and sanitation (23 CFR 635). The contractor shall provide all safeguards, safety devices and protective equipment and take any other needed actions as it determines, or as the contracting officer may determine, to be reasonably necessary to protect the life and health of employees on the job and the safety of the public and to protect property in connection with the performance of the work covered by the contract.

2. It is a condition of this contract, and shall be made a condition of each subcontract, which the contractor enters into pursuant to this contract, that the contractor and any subcontractor shall not permit any employee, in performance of the contract, to work in surroundings or under conditions which are unsanitary, hazardous or dangerous to his/her health or safety, as determined under construction safety and health standards (29 CFR 1926) promulgated by the Secretary of Labor, in accordance with Section 107 of the Contract Work Hours and Safety Standards Act (40 U.S.C. 3704).

3. Pursuant to 29 CFR 1926.3, it is a condition of this contract that the Secretary of Labor or authorized representative thereof, shall have right of entry to any site of contract performance to inspect or investigate the matter of compliance with the construction safety and health standards and to carry out the duties of the Secretary under Section 107 of the Contract Work Hours and Safety Standards Act (40 U.S.C.3704).

## VIII. FALSE STATEMENTS CONCERNING HIGHWAY PROJECTS

This provision is applicable to all Federal-aid construction contracts and to all related subcontracts.

In order to assure high quality and durable construction in conformity with approved plans and specifications and a high degree of reliability on statements and representations made by engineers, contractors, suppliers, and workers on Federal-aid highway projects, it is essential that all persons concerned with the project perform their functions as carefully, thoroughly, and honestly as possible. Willful falsification, distortion, or misrepresentation with respect to any facts related to the project is a violation of Federal law. To prevent any misunderstanding regarding the seriousness of these and similar acts, Form FHWA-1022 shall be posted on each Federal-aid highway project (23 CFR 635) in one or more places where it is readily available to all persons concerned with the project:

18 U.S.C. 1020 reads as follows:

"Whoever, being an officer, agent, or employee of the United States, or of any State or Territory, or whoever, whether a person, association, firm, or corporation, knowingly makes any false statement, false representation, or false report as to the character, quality, quantity, or cost of the material used or to be used, or the quantity or quality of the work performed or to be performed, or the cost thereof in connection with the submission of plans, maps, specifications, contracts, or costs of construction on any highway or related project submitted for approval to the Secretary of Transportation; or

Whoever knowingly makes any false statement, false representation, false report or false claim with respect to the character, quality, quantity, or cost of any work performed or to be performed, or materials furnished or to be furnished, in connection with the construction of any highway or related project approved by the Secretary of Transportation; or

Whoever knowingly makes any false statement or false representation as to material fact in any statement, certificate, or report submitted pursuant to provisions of the Federal-aid Roads Act approved July 1, 1916, (39 Stat. 355), as amended and supplemented;

Shall be fined under this title or imprisoned not more than 5 years or both."

#### **IX. IMPLEMENTATION OF CLEAN AIR ACT AND FEDERAL WATER POLLUTION CONTROL ACT**

This provision is applicable to all Federal-aid construction contracts and to all related subcontracts.

By submission of this bid/proposal or the execution of this contract, or subcontract, as appropriate, the bidder, proposer, Federal-aid construction contractor, or subcontractor, as appropriate, will be deemed to have stipulated as follows:

1. That any person who is or will be utilized in the performance of this contract is not prohibited from receiving an award due to a violation of Section 508 of the Clean Water Act or Section 306 of the Clean Air Act.

2. That the contractor agrees to include or cause to be included the requirements of paragraph (1) of this Section X in every subcontract, and further agrees to take such action as the contracting agency may direct as a means of enforcing such requirements.

#### **X. CERTIFICATION REGARDING DEBARMENT, SUSPENSION, INELIGIBILITY AND VOLUNTARY EXCLUSION**

This provision is applicable to all Federal-aid construction contracts, design-build contracts, subcontracts, lower-tier subcontracts, purchase orders, lease agreements, consultant contracts or any other covered transaction requiring FHWA approval or that is estimated to cost \$25,000 or more – as defined in 2 CFR Parts 180 and 1200.

##### **1. Instructions for Certification – First Tier Participants:**

a. By signing and submitting this proposal, the prospective first tier participant is providing the certification set out below.

b. The inability of a person to provide the certification set out below will not necessarily result in denial of participation in this

covered transaction. The prospective first tier participant shall submit an explanation of why it cannot provide the certification set out below. The certification or explanation will be considered in connection with the department or agency's determination whether to enter into this transaction. However, failure of the prospective first tier participant to furnish a certification or an explanation shall disqualify such a person from participation in this transaction.

c. The certification in this clause is a material representation of fact upon which reliance was placed when the contracting agency determined to enter into this transaction. If it is later determined that the prospective participant knowingly rendered an erroneous certification, in addition to other remedies available to the Federal Government, the contracting agency may terminate this transaction for cause of default.

d. The prospective first tier participant shall provide immediate written notice to the contracting agency to whom this proposal is submitted if any time the prospective first tier participant learns that its certification was erroneous when submitted or has become erroneous by reason of changed circumstances.

e. The terms "covered transaction," "debarred," "suspended," "ineligible," "participant," "person," "principal," and "voluntarily excluded," as used in this clause, are defined in 2 CFR Parts 180 and 1200. "First Tier Covered Transactions" refers to any covered transaction between a grantee or subgrantee of Federal funds and a participant (such as the prime or general contract). "Lower Tier Covered Transactions" refers to any covered transaction under a First Tier Covered Transaction (such as subcontracts). "First Tier Participant" refers to the participant who has entered into a covered transaction with a grantee or subgrantee of Federal funds (such as the prime or general contractor). "Lower Tier Participant" refers any participant who has entered into a covered transaction with a First Tier Participant or other Lower Tier Participants (such as subcontractors and suppliers).

f. The prospective first tier participant agrees by submitting this proposal that, should the proposed covered transaction be entered into, it shall not knowingly enter into any lower tier covered transaction with a person who is debarred, suspended, declared ineligible, or voluntarily excluded from participation in this covered transaction, unless authorized by the department or agency entering into this transaction.

g. The prospective first tier participant further agrees by submitting this proposal that it will include the clause titled "Certification Regarding Debarment, Suspension, Ineligibility and Voluntary Exclusion-Lower Tier Covered Transactions," provided by the department or contracting agency, entering into this covered transaction, without modification, in all lower tier covered transactions and in all solicitations for lower tier covered transactions exceeding the \$25,000 threshold.

h. A participant in a covered transaction may rely upon a certification of a prospective participant in a lower tier covered transaction that is not debarred, suspended, ineligible, or voluntarily excluded from the covered transaction, unless it knows that the certification is erroneous. A participant is responsible for ensuring that its principals are not suspended, debarred, or otherwise ineligible to participate in covered transactions. To verify the eligibility of its principals, as well as the eligibility of any lower tier prospective participants, each participant may, but is not required to, check the Excluded Parties List System website (<https://www.epls.gov/>), which is compiled by the General Services Administration.

i. Nothing contained in the foregoing shall be construed to require the establishment of a system of records in order to render in good faith the certification required by this clause. The knowledge and information of the prospective participant is not required to exceed that which is normally possessed by a prudent person in the ordinary course of business dealings.

j. Except for transactions authorized under paragraph (f) of these instructions, if a participant in a covered transaction knowingly enters into a lower tier covered transaction with a person who is suspended, debarred, ineligible, or voluntarily excluded from participation in this transaction, in addition to other remedies available to the Federal Government, the department or agency may terminate this transaction for cause or default.

\* \* \* \* \*

## **2. Certification Regarding Debarment, Suspension, Ineligibility and Voluntary Exclusion – First Tier Participants:**

a. The prospective first tier participant certifies to the best of its knowledge and belief, that it and its principals:

(1) Are not presently debarred, suspended, proposed for debarment, declared ineligible, or voluntarily excluded from participating in covered transactions by any Federal department or agency;

(2) Have not within a three-year period preceding this proposal been convicted of or had a civil judgment rendered against them for commission of fraud or a criminal offense in connection with obtaining, attempting to obtain, or performing a public (Federal, State or local) transaction or contract under a public transaction; violation of Federal or State antitrust statutes or commission of embezzlement, theft, forgery, bribery, falsification or destruction of records, making false statements, or receiving stolen property;

(3) Are not presently indicted for or otherwise criminally or civilly charged by a governmental entity (Federal, State or local) with commission of any of the offenses enumerated in paragraph (a)(2) of this certification; and

(4) Have not within a three-year period preceding this application/proposal had one or more public transactions (Federal, State or local) terminated for cause or default.

b. Where the prospective participant is unable to certify to any of the statements in this certification, such prospective participant shall attach an explanation to this proposal.

### **2. Instructions for Certification - Lower Tier Participants:**

(Applicable to all subcontracts, purchase orders and other lower tier transactions requiring prior FHWA approval or estimated to cost \$25,000 or more - 2 CFR Parts 180 and 1200)

a. By signing and submitting this proposal, the prospective lower tier is providing the certification set out below.

b. The certification in this clause is a material representation of fact upon which reliance was placed when this transaction was entered into. If it is later determined that the prospective lower tier participant knowingly rendered an erroneous certification, in addition to other remedies available to the Federal Government, the department, or agency with which

this transaction originated may pursue available remedies, including suspension and/or debarment.

c. The prospective lower tier participant shall provide immediate written notice to the person to which this proposal is submitted if at any time the prospective lower tier participant learns that its certification was erroneous by reason of changed circumstances.

d. The terms "covered transaction," "debarred," "suspended," "ineligible," "participant," "person," "principal," and "voluntarily excluded," as used in this clause, are defined in 2 CFR Parts 180 and 1200. You may contact the person to which this proposal is submitted for assistance in obtaining a copy of those regulations. "First Tier Covered Transactions" refers to any covered transaction between a grantee or subgrantee of Federal funds and a participant (such as the prime or general contract). "Lower Tier Covered Transactions" refers to any covered transaction under a First Tier Covered Transaction (such as subcontracts). "First Tier Participant" refers to the participant who has entered into a covered transaction with a grantee or subgrantee of Federal funds (such as the prime or general contractor). "Lower Tier Participant" refers any participant who has entered into a covered transaction with a First Tier Participant or other Lower Tier Participants (such as subcontractors and suppliers).

e. The prospective lower tier participant agrees by submitting this proposal that, should the proposed covered transaction be entered into, it shall not knowingly enter into any lower tier covered transaction with a person who is debarred, suspended, declared ineligible, or voluntarily excluded from participation in this covered transaction, unless authorized by the department or agency with which this transaction originated.

f. The prospective lower tier participant further agrees by submitting this proposal that it will include this clause titled "Certification Regarding Debarment, Suspension, Ineligibility and Voluntary Exclusion-Lower Tier Covered Transaction," without modification, in all lower tier covered transactions and in all solicitations for lower tier covered transactions exceeding the \$25,000 threshold.

g. A participant in a covered transaction may rely upon a certification of a prospective participant in a lower tier covered transaction that is not debarred, suspended, ineligible, or voluntarily excluded from the covered transaction, unless it knows that the certification is erroneous. A participant is responsible for ensuring that its principals are not suspended, debarred, or otherwise ineligible to participate in covered transactions. To verify the eligibility of its principals, as well as the eligibility of any lower tier prospective participants, each participant may, but is not required to, check the Excluded Parties List System website (<https://www.epls.gov/>), which is compiled by the General Services Administration.

h. Nothing contained in the foregoing shall be construed to require establishment of a system of records in order to render in good faith the certification required by this clause. The knowledge and information of participant is not required to exceed that which is normally possessed by a prudent person in the ordinary course of business dealings.

i. Except for transactions authorized under paragraph e of these instructions, if a participant in a covered transaction knowingly enters into a lower tier covered transaction with a person who is suspended, debarred, ineligible, or voluntarily excluded from participation in this transaction, in addition to other remedies available to the Federal Government, the

department or agency with which this transaction originated may pursue available remedies, including suspension and/or debarment.

\* \* \* \* \*

**Certification Regarding Debarment, Suspension, Ineligibility and Voluntary Exclusion--Lower Tier Participants:**

1. The prospective lower tier participant certifies, by submission of this proposal, that neither it nor its principals is presently debarred, suspended, proposed for debarment, declared ineligible, or voluntarily excluded from participating in covered transactions by any Federal department or agency.

2. Where the prospective lower tier participant is unable to certify to any of the statements in this certification, such prospective participant shall attach an explanation to this proposal.

\* \* \* \* \*

**XI. CERTIFICATION REGARDING USE OF CONTRACT FUNDS FOR LOBBYING**

This provision is applicable to all Federal-aid construction contracts and to all related subcontracts which exceed \$100,000 (49 CFR 20).

1. The prospective participant certifies, by signing and submitting this bid or proposal, to the best of his or her knowledge and belief, that:

a. No Federal appropriated funds have been paid or will be paid, by or on behalf of the undersigned, to any person for influencing or attempting to influence an officer or employee of any Federal agency, a Member of Congress, an officer or employee of Congress, or an employee of a Member of Congress in connection with the awarding of any Federal contract, the making of any Federal grant, the making of any Federal loan, the entering into of any cooperative agreement, and the extension, continuation, renewal, amendment, or modification of any Federal contract, grant, loan, or cooperative agreement.

b. If any funds other than Federal appropriated funds have been paid or will be paid to any person for influencing or attempting to influence an officer or employee of any Federal agency, a Member of Congress, an officer or employee of Congress, or an employee of a Member of Congress in connection with this Federal contract, grant, loan, or cooperative agreement, the undersigned shall complete and submit Standard Form-LLL, "Disclosure Form to Report Lobbying," in accordance with its instructions.

2. This certification is a material representation of fact upon which reliance was placed when this transaction was made or entered into. Submission of this certification is a prerequisite for making or entering into this transaction imposed by 31 U.S.C. 1352. Any person who fails to file the required certification shall be subject to a civil penalty of not less than \$10,000 and not more than \$100,000 for each such failure.

3. The prospective participant also agrees by submitting its bid or proposal that the participant shall require that the language of this certification be included in all lower tier subcontracts, which exceed \$100,000 and that all such recipients shall certify and disclose accordingly.

**ATTACHMENT A - EMPLOYMENT AND MATERIALS PREFERENCE FOR APPALACHIAN DEVELOPMENT HIGHWAY SYSTEM OR APPALACHIAN LOCAL ACCESS ROAD CONTRACTS**

This provision is applicable to all Federal-aid projects funded under the Appalachian Regional Development Act of 1965.

1. During the performance of this contract, the contractor undertaking to do work which is, or reasonably may be, done as on-site work, shall give preference to qualified persons who regularly reside in the labor area as designated by the DOL wherein the contract work is situated, or the subregion, or the Appalachian counties of the State wherein the contract work is situated, except:

a. To the extent that qualified persons regularly residing in the area are not available.

b. For the reasonable needs of the contractor to employ supervisory or specially experienced personnel necessary to assure an efficient execution of the contract work.

c. For the obligation of the contractor to offer employment to present or former employees as the result of a lawful collective bargaining contract, provided that the number of nonresident persons employed under this subparagraph (1c) shall not exceed 20 percent of the total number of employees employed by the contractor on the contract work, except as provided in subparagraph (4) below.

2. The contractor shall place a job order with the State Employment Service indicating (a) the classifications of the laborers, mechanics and other employees required to perform the contract work, (b) the number of employees required in each classification, (c) the date on which the participant estimates such employees will be required, and (d) any other pertinent information required by the State Employment Service to complete the job order form. The job order may be placed with the State Employment Service in writing or by telephone. If during the course of the contract work, the information submitted by the contractor in the original job order is substantially modified, the participant shall promptly notify the State Employment Service.

3. The contractor shall give full consideration to all qualified job applicants referred to him by the State Employment Service. The contractor is not required to grant employment to any job applicants who, in his opinion, are not qualified to perform the classification of work required.

4. If, within one week following the placing of a job order by the contractor with the State Employment Service, the State Employment Service is unable to refer any qualified job applicants to the contractor, or less than the number requested, the State Employment Service will forward a certificate to the contractor indicating the unavailability of applicants. Such certificate shall be made a part of the contractor's permanent project records. Upon receipt of this certificate, the contractor may employ persons who do not normally reside in the labor area to fill positions covered by the certificate, notwithstanding the provisions of subparagraph (1c) above.

5. The provisions of 23 CFR 633.207(e) allow the contracting agency to provide a contractual preference for the use of mineral resource materials native to the Appalachian region.

6. The contractor shall include the provisions of Sections 1 through 4 of this Attachment A in every subcontract for work which is, or reasonably may be, done as on-site work.

## Female and Minority Goals

To comply with Section II, "Nondiscrimination," of "Required Contract Provisions Federal-Aid Construction Contracts," the following female and minority utilization goals for Federal-aid construction contracts and subcontracts that exceed \$10,000.

The nationwide goal for female utilization is 6.9 percent.

The goals for minority utilization [45 Fed Reg 65984 (10/3/1980)] are as follows:

### Minority Utilization Goals

	Economic Area	Goal (Percent)
174	Redding CA: Non-SMSA Counties: CA Lassen; CA Modoc; CA Plumas; CA Shasta; CA Siskiyou; CA Tehama	6.8
175	Eureka, CA Non-SMSA Counties: CA Del Norte; CA Humboldt; CA Trinity	6.6
176	San Francisco-Oakland-San Jose, CA: SMSA Counties: 7120 Salinas-Seaside-Monterey, CA CA Monterey 7360 San Francisco-Oakland CA Alameda; CA Contra Costa; CA Marin; CA San Francisco; CA San Mateo 7400 San Jose, CA CA Santa Clara, CA 7485 Santa Cruz, CA CA Santa Cruz 7500 Santa Rosa CA Sonoma 8720 Vallejo-Fairfield-Napa, CA CA Napa; CA Solano Non-SMSA Counties: CA Lake; CA Mendocino; CA San Benito	28.9 25.6 19.6 14.9 9.1 17.1 23.2
177	Sacramento, CA: SMSA Counties: 6920 Sacramento, CA CA Placer; CA Sacramento; CA Yolo Non-SMSA Counties CA Butte; CA Colusa; CA El Dorado; CA Glenn; CA Nevada; CA Sierra; CA Sutter; CA Yuba	16.1 14.3
178	Stockton-Modesto, CA: SMSA Counties: 5170 Modesto, CA CA Stanislaus 8120 Stockton, CA CA San Joaquin Non-SMSA Counties CA Alpine; CA Amador; CA Calaveras; CA Mariposa; CA Merced; CA Tuolumne	12.3 24.3 19.8
179	Fresno-Bakersfield, CA SMSA Counties: 0680 Bakersfield, CA CA Kern 2840 Fresno, CA CA Fresno Non-SMSA Counties:	19.1 26.1 23.6
	<sup>14</sup> CA Kings; CA Madera; CA Tulare	



180	Los Angeles, CA: SMSA Counties: 0360 Anaheim-Santa Ana-Garden Grove, CA CA Orange 4480 Los Angeles-Long Beach, CA CA Los Angeles 6000 Oxnard-Simi Valley-Ventura, CA CA Ventura 6780 Riverside-San Bernardino-Ontario, CA CA Riverside; CA San Bernardino 7480 Santa Barbara-Santa Maria-Lompoc, CA CA Santa Barbara Non-SMSA Counties CA Inyo; CA Mono; CA San Luis Obispo	11.9          28.3       21.5       19.0       19.7       24.6
181	San Diego, CA: SMSA Counties 7320 San Diego, CA CA San Diego Non-SMSA Counties CA Imperial	16.9          18.2

For each July during which work is performed under the contract, you and each non-material-supplier subcontractor with a subcontract of \$10,000 or more must complete Form FHWA PR-1391 (Appendix C to 23 CFR 230). Submit the forms by August 15.

**Federal Trainee Program**

For the Federal training program, the number of trainees or apprentices is 0.

This section applies if a number of trainees or apprentices is specified in the special provisions.

As part of your equal opportunity affirmative action program, provide on-the-job training to develop full journeymen in the types of trades or job classifications involved.

You have primary responsibility for meeting this training requirement.

If you subcontract a contract part, determine how many trainees or apprentices are to be trained by the subcontractor.

Include these training requirements in your subcontract.

Where feasible, 25 percent of apprentices or trainees in each occupation must be in their 1st year of apprenticeship or training.

Distribute the number of apprentices or trainees among the work classifications on the basis of your needs and the availability of journeymen in the various classifications within a reasonable recruitment area.

Before starting work, submit to the County of Humboldt:

1. Number of apprentices or trainees to be trained for each classification
2. Training program to be used
3. Training starting date for each classification

Obtain the County of Humboldt approval for this submitted information before you start work. The County of Humboldt credits you for each apprentice or trainee you employ on the work who is currently enrolled or becomes enrolled in an approved program.

The primary objective of this section is to train and upgrade minorities and women toward journeymen status. Make every effort to enroll minority and women apprentices or trainees, such as conducting systematic and direct recruitment through public and private sources likely to yield minority and women apprentices or

trainees, to the extent they are available within a reasonable recruitment area. Show that you have made the efforts. In making these efforts, do not discriminate against any applicant for training.

Do not employ as an apprentice or trainee an employee:

1. In any classification in which the employee has successfully completed a training course leading to journeyman status or in which the employee has been employed as a journeyman
2. Who is not registered in a program approved by the US Department of Labor, Bureau of Apprenticeship and Training

Ask the employee if the employee has successfully completed a training course leading to journeyman status or has been employed as a journeyman. Your records must show the employee's answers to the questions.

In your training program, establish the minimum length and training type for each classification. The County of Humboldt and FHWA approves a program if one of the following is met:

1. It is calculated to:
  - Meet the your equal employment opportunity responsibilities
  - Qualify the average apprentice or trainee for journeyman status in the classification involved by the end of the training period
2. It is registered with the U.S. Department of Labor, Bureau of Apprenticeship and Training, and it is administered in a way consistent with the equal employment responsibilities of Federal-aid highway construction contracts

Obtain the State's approval for your training program before you start work involving the classification covered by the program.

Provide training in the construction crafts, not in clerk-typist or secretarial-type positions. Training is allowed in lower level management positions such as office engineers, estimators, and timekeepers if the training is oriented toward construction applications. Training is allowed in the laborer classification if significant and meaningful training is provided and approved by the division office. Off-site training is allowed if the training is an integral part of an approved training program and does not make up a significant part of the overall training.

The County of Humboldt reimburses you 80 cents per hour of training given an employee on this contract under an approved training program:

1. For on-site training
2. For off-site training if the apprentice or trainee is currently employed on a Federal-aid project and you do at least one of the following:
  - Contribute to the cost of the training
  - Provide the instruction to the apprentice or trainee
  - Pay the apprentice's or trainee's wages during the off-site training period
3. If you comply this section.

Each apprentice or trainee must:

1. Begin training on the project as soon as feasible after the start of work involving the apprentice's or trainee's skill
2. Remain on the project as long as training opportunities exist in the apprentice's or trainee's work classification or until the apprentice or trainee has completed the training program

Furnish the apprentice or trainee:

1. Copy of the program you will comply with in providing the training
2. Certification showing the type and length of training satisfactorily completed

## **Title VI Assurances**

During the performance of this Agreement, the contractor, for itself, its assignees and successors in interest (hereinafter collectively referred to as CONTRACTOR) agrees as follows:

- (1) Compliance with Regulations: CONTRACTOR shall comply with the regulations relative to nondiscrimination in federally assisted programs of the Department of Transportation, Title 49, Code of Federal Regulations, Part 21, as they may be amended from time to time, (hereinafter referred to as the REGULATIONS), which are herein incorporated by reference and made a part of this agreement.
- (2) Nondiscrimination: CONTRACTOR, with regard to the work performed by it during the AGREEMENT, shall not discriminate on the grounds of race, color, sex, national origin, religion, age, or disability in the selection and retention of sub-applicants, including procurements of materials and leases of equipment. CONTRACTOR shall not participate either directly or indirectly in the discrimination prohibited by Section 21.5 of the Regulations, including employment practices when the agreement covers a program set forth in Appendix B of the Regulations.
- (3) Solicitations for Sub-agreements, Including Procurements of Materials and Equipment: In all solicitations either by competitive bidding or negotiation made by CONTRACTOR for work to be performed under a Sub-agreement, including procurements of materials or leases of equipment, each potential sub-applicant or supplier shall be notified by CONTRACTOR of the CONTRACTOR'S obligations under this Agreement and the Regulations relative to nondiscrimination on the grounds of race, color, or national origin.
- (4) Information and Reports: CONTRACTOR shall provide all information and reports required by the Regulations, or directives issued pursuant thereto, and shall permit access to its books, records, accounts, other sources of information, and its facilities as may be determined by the California Department of Transportation or FHWA to be pertinent to ascertain compliance with such Regulations or directives. Where any information required of CONTRACTOR is in the exclusive possession of another who fails or refuses to furnish this information, CONTRACTOR shall so certify to the California Department of Transportation or the FHWA as appropriate, and shall set forth what efforts CONTRACTOR has made to obtain the information.
- (5) Sanctions for Noncompliance: In the event of CONTRACTOR'S noncompliance with the nondiscrimination provisions of this agreement, the California Department of Transportation shall impose such agreement sanctions as it or the FHWA may determine to be appropriate, including, but not limited to:
  - (a) withholding of payments to CONTRACTOR under the Agreement within a reasonable period of time, not to exceed 90 days; and/or
  - (b) cancellation, termination or suspension of the Agreement, in whole or in part.
- (6) Incorporation of Provisions: CONTRACTOR shall include the provisions of paragraphs (1) through (6) in every sub-agreement, including procurements of materials and leases of equipment, unless exempt by the Regulations, or directives issued pursuant thereto.

CONTRACTOR shall take such action with respect to any sub-agreement or procurement as the California Department of Transportation or FHWA may direct as a means of enforcing such provisions including sanctions for noncompliance, provided, however, that, in the event CONTRACTOR becomes involved in, or is threatened with, litigation with a sub-applicant or supplier as a result of such direction, CONTRACTOR may request the California Department of Transportation enter into such litigation to protect the interests of the State, and, in addition, CONTRACTOR may request the United States to enter into such litigation to protect the interests of the United States.

**MAINTAIN RECORDS AND SUBMIT REPORTS DOCUMENTING YOUR PERFORMANCE UNDER THIS SECTION**

^^

"General Decision Number: CA20210004 04/23/2021

Superseded General Decision Number: CA20200004

State: California

Construction Types: Heavy (Heavy and Dredging) and Highway

Counties: Del Norte, Humboldt, Lake and Mendocino Counties in California.

DREDGING PROJECTS (does not include hopper dredge work); HEAVY CONSTRUCTION PROJECTS (does not include water well drilling); AND HIGHWAY CONSTRUCTION PROJECTS

Note: Under Executive Order (EO) 13658, an hourly minimum wage of \$10.95 for calendar year 2021 applies to all contracts subject to the Davis-Bacon Act for which the contract is awarded (and any solicitation was issued) on or after January 1, 2015. If this contract is covered by the EO, the contractor must pay all workers in any classification listed on this wage determination at least \$10.95 per hour (or the applicable wage rate listed on this wage determination, if it is higher) for all hours spent performing on the contract in calendar year 2021. If this contract is covered by the EO and a classification considered necessary for performance of work on the contract does not appear on this wage determination, the contractor must pay workers in that classification at least the wage rate determined through the conformance process set forth in 29 CFR 5.5(a)(1)(ii) (or the EO minimum wage rate, if it is higher than the conformed wage rate). The EO minimum wage rate will be adjusted annually. Please note that this EO applies to the above-mentioned types of contracts entered into by the federal government that are subject to the Davis-Bacon Act itself, but it does not apply to contracts subject only to the Davis-Bacon Related Acts, including those set forth at 29 CFR 5.1(a)(2)-(60). Additional information on contractor requirements and worker protections under the EO is available at [www.dol.gov/whd/govcontracts](http://www.dol.gov/whd/govcontracts).

Modification Number	Publication Date
0	01/01/2021
1	02/26/2021
2	04/02/2021
3	04/23/2021

ASBE0016-005 01/01/2021

	Rates	Fringes
Asbestos Workers/Insulator (Includes the application of all insulating materials, Protective Coverings, Coatings, and Finishes to all types of mechanical systems)		
(1) Mendocino County.....	\$ 46.81	33.50
(2) Del Norte, Humboldt, Lake Counties.....	\$ 46.81	33.50

ASBE0016-006 01/01/2021

	Rates	Fringes
Asbestos Removal worker/hazardous material handler (Includes preparation, wetting, stripping, removal, scrapping, vacuuming, bagging and disposing of all insulation materials from mechanical systems, whether they contain asbestos or not)....	\$ 30.45	10.60

BRCA0003-001 08/01/2020

	Rates	Fringes
MARBLE FINISHER.....	\$ 36.53	17.08

BRCA0003-003 08/01/2020

	Rates	Fringes
MARBLE MASON.....	\$ 51.30	28.47

BRCA0003-006 05/01/2020

	Rates	Fringes
--	-------	---------

BRICKLAYER.....\$ 47.65 27.47

SPECIALTY PAY:

- (A) Underground work such as tunnel work, sewer work, manholes, catch basins, sewer pipes and telephone conduit shall be paid \$1.25 per hour above the regular rate. Work in direct contact with raw sewage shall receive \$1.25 per hour in addition to the above.
- (B) Operating a saw or grinder shall receive \$1.25 per hour above the regular rate.
- (C) Gunite nozzle person shall receive \$1.25 per hour above the regular rate.

-----  
BRCA0003-008 07/01/2019

	Rates	Fringes
TERRAZZO FINISHER.....	\$ 37.58	17.33
TERRAZZO WORKER/SETTER.....	\$ 48.53	26.84

-----  
BRCA0003-013 04/01/2020

	Rates	Fringes
TILE FINISHER		
Del Norte & Humboldt		
Counties.....	\$ 31.22	17.10
Lake & Mendocino Counties...	\$ 29.34	16.54
TILE LAYER		
Del Norte & Humboldt		
Counties.....	\$ 52.03	20.31
Lake & Mendocino Counties...	\$ 48.90	20.23

-----  
CARP0034-001 07/01/2020

	Rates	Fringes
Diver		
Assistant Tender, ROV		
Tender/Technician.....	\$ 51.90	34.02
Diver standby.....	\$ 58.09	34.02
Diver Tender.....	\$ 57.09	34.02
Diver wet.....	\$ 101.42	34.02
Manifold Operator (mixed		
gas).....	\$ 62.09	34.02
Manifold Operator (Standby).\$	57.09	34.02

DEPTH PAY (Surface Diving):  
 050 to 100 ft \$2.00 per foot  
 101 to 150 ft \$3.00 per foot  
 151 to 220 ft \$4.00 per foot  
 221 ft.-deeper \$5.00 per foot

SATURATION DIVING:  
 The standby rate shall apply until saturation starts. The saturation diving rate applies when divers are under pressure continuously until work task and decompression are complete. The diver rate shall be paid for all saturation hours.

DIVING IN ENCLOSURES:  
 Where it is necessary for Divers to enter pipes or tunnels, or other enclosures where there is no vertical ascent, the following premium shall be paid: Distance traveled from entrance 26 feet to 300 feet: \$1.00 per foot. When it is necessary for a diver to enter any pipe, tunnel or other enclosure less than 48" in height, the premium will be \$1.00 per foot.

WORK IN COMBINATION OF CLASSIFICATIONS:  
 Employees working in any combination of classifications within the diving crew (except dive supervisor) in a shift are paid in the classification with the highest rate for that shift.

-----  
CARP0034-003 07/01/2020

	Rates	Fringes
Piledriver.....	\$ 51.90	34.02

-----  
CARP0751-002 07/01/2020

Del Norte, Humboldt, Lake and Mendocino Counties		
	Rates	Fringes
Carpenters		
Bridge Builder/Highway		
Carpenter.....	\$ 52.65	30.82
Hardwood Floorlayer,		
Shingler, Power Saw		

Operator, Steel Scaffold & Steel Shoring Erector, Saw Filer.....	\$ 45.57	30.82
Journeyman Carpenter.....	\$ 45.42	30.82
Millwright.....	\$ 47.92	32.41

-----  
ELEC0551-001 06/01/2020

LAKE AND MENDOCINO COUNTIES

	Rates	Fringes
ELECTRICIAN.....	\$ 52.40	3%+23.31

TUNNEL WORK: Add \$0.50 per hour.

-----  
ELEC0551-002 06/01/2020

DEL NORTE AND HUMBOLDT COUNTIES

	Rates	Fringes
Electricians:.....	\$ 52.40	3%+23.31

TUNNEL WORK: Add \$0.50 per hour.

-----  
ELEC1245-002 06/01/2020

HUMBOLDT, LAKE AND MENDOCINO COUNTIES

	Rates	Fringes
LINE CONSTRUCTION		
(1) Lineman; Cable splicer..	\$ 59.14	20.78
(2) Equipment specialist (operates crawler tractors, commercial motor vehicles, backhoes, trenchers, cranes (50 tons and below), overhead & underground distribution line equipment).....	\$ 47.24	19.59
(3) Groundman.....	\$ 36.12	19.19
(4) Powderman.....	\$ 51.87	18.79

HOLIDAYS: New Year's Day, M.L. King Day, Memorial Day,  
Independence Day, Labor Day, Veterans Day, Thanksgiving Day  
and day after Thanksgiving, Christmas Day

-----  
ENGI0003-014 06/29/2020

""AREA 1"" WAGE RATES ARE LISTED BELOW

""AREA 2"" RECEIVES AN ADDITIONAL \$2.00 PER HOUR ABOVE AREA 1  
RATES.

SEE AREA DEFINITIONS BELOW

	Rates	Fringes
OPERATOR: Power Equipment (AREA 1:)		
GROUP 1.....	\$ 51.42	31.15
GROUP 2.....	\$ 49.89	31.15
GROUP 3.....	\$ 48.41	31.15
GROUP 4.....	\$ 47.03	31.15
GROUP 5.....	\$ 45.76	31.15
GROUP 6.....	\$ 44.44	31.15
GROUP 7.....	\$ 43.30	31.15
GROUP 8.....	\$ 42.16	31.15
GROUP 8-A.....	\$ 39.95	31.15
OPERATOR: Power Equipment (Cranes and Attachments - AREA 1:)		
GROUP 1		
Cranes.....	\$ 52.30	31.15
Oiler.....	\$ 43.79	31.15
Truck crane oiler.....	\$ 46.08	31.15
GROUP 2		
Cranes.....	\$ 50.54	31.15
Oiler.....	\$ 42.83	31.15
Truck crane oiler.....	\$ 45.07	31.15
GROUP 3		
Cranes.....	\$ 48.80	31.15
Hydraulic.....	\$ 44.44	31.15
Oiler.....	\$ 42.55	31.15
Truck crane oiler.....	\$ 44.83	31.15
GROUP 4		
Cranes.....	\$ 45.76	31.15
OPERATOR: Power Equipment (Piledriving - AREA 1:)		
GROUP 1		

Lifting devices.....	\$ 52.64	31.15
Oiler.....	\$ 43.38	31.15
Truck Crane Oiler.....	\$ 45.66	31.15
GROUP 2		
Lifting devices.....	\$ 50.82	31.15
Oiler.....	\$ 43.11	31.15
Truck Crane Oiler.....	\$ 45.41	31.15
GROUP 3		
Lifting devices.....	\$ 49.14	31.15
Oiler.....	\$ 42.89	31.15
Truck Crane Oiler.....	\$ 45.12	31.15
GROUP 4		
Lifting devices.....	\$ 47.37	31.15
GROUP 5		
Lifting devices.....	\$ 44.73	31.15
GROUP 6		
Lifting devices.....	\$ 42.50	31.15
OPERATOR: Power Equipment (Steel Erection - AREA 1:)		
GROUP 1		
Cranes.....	\$ 53.27	31.15
Oiler.....	\$ 43.72	31.15
Truck Crane Oiler.....	\$ 45.95	31.15
GROUP 2		
Cranes.....	\$ 51.50	31.15
Oiler.....	\$ 43.45	31.15
Truck Crane Oiler.....	\$ 45.73	31.15
GROUP 3		
Cranes.....	\$ 50.02	31.15
Hydraulic.....	\$ 45.07	31.15
Oiler.....	\$ 43.23	31.15
Truck Crane Oiler.....	\$ 45.46	31.15
GROUP 4		
Cranes.....	\$ 48.00	31.15
GROUP 5		
Cranes.....	\$ 46.70	31.15
OPERATOR: Power Equipment (Tunnel and Underground Work - AREA 1:)		
SHAFTS, STOPES, RAISES:		
GROUP 1.....	\$ 47.52	31.15
GROUP 1-A.....	\$ 49.99	31.15
GROUP 2.....	\$ 46.26	31.15
GROUP 3.....	\$ 44.93	31.15
GROUP 4.....	\$ 43.79	31.15
GROUP 5.....	\$ 42.65	31.15
UNDERGROUND:		
GROUP 1.....	\$ 47.42	31.15
GROUP 1-A.....	\$ 49.89	31.15
GROUP 2.....	\$ 46.16	31.15
GROUP 3.....	\$ 44.83	31.15
GROUP 4.....	\$ 43.69	31.15
GROUP 5.....	\$ 42.55	31.15

FOOTNOTE: Work suspended by ropes or cables, or work on a Yo-Yo Cat: \$.60 per hour additional.

POWER EQUIPMENT OPERATOR CLASSIFICATIONS

GROUP 1: Operator of helicopter (when used in erection work); Hydraulic excavator, 7 cu. yds. and over; Power shovels, over 7 cu. yds.

GROUP 2: Highline cableway; Hydraulic excavator, 3-1/2 cu. yds. up to 7 cu. yds.; Licensed construction work boat operator, on site; Power blade operator (finish); Power shovels, over 1 cu. yd. up to and including 7 cu. yds. m.r.c.

GROUP 3: Asphalt milling machine; Cable backhoe; Combination backhoe and loader over 3/4 cu. yds.; Continuous flight tie back machine assistant to engineer or mechanic; Crane mounted continuous flight tie back machine, tonnage to apply; Crane mounted drill attachment, tonnage to apply; Dozer, slope brd; Gradall; Hydraulic excavator, up to 3 1/2 cu. yds.; Loader 4 cu. yds. and over; Long reach excavator; Multiple engine scraper (when used as push pull); Power shovels, up to and including 1 cu. yd.; Pre-stress wire wrapping machine; Side boom cat, 572 or larger; Track loader 4 cu. yds. and over; Wheel excavator (up to and including 750 cu. yds. per hour)

GROUP 4: Asphalt plant engineer/box person; Chicago boom; Combination backhoe and loader up to and including 3/4 cu. yd.; Concrete batch plant (wet or dry); Dozer and/or push cat; Pull- type elevating loader; Gradesetter, grade checker (GPS, mechanical or otherwise); Grooving and grinding machine; Heading shield operator; Heavy-duty drilling equipment, Hughes, LDH, Watson 3000 or similar; Heavy-duty repairperson and/or welder; Lime spreader; Loader under 4 cu. yds.; Lubrication and service engineer (mobile and grease rack); Mechanical finishers or spreader machine (asphalt, Barber-Greene and similar); Miller

Formless M-9000 slope paver or similar; Portable crushing and screening plants; Power blade support; Roller operator, asphalt; Rubber-tired scraper, self-loading (paddle-wheels, etc.); Rubber-tired earthmoving equipment (scrapers); Slip form paver (concrete); Small tractor with drag; Soil stabilizer (P & H or equal); Spider plow and spider puller; Tubex pile rig; Unlicensed construction work boat operator, on site; Timber skidder; Track loader up to 4 yds.; Tractor-drawn scraper; Tractor, compressor drill combination; Welder; Woods-Mixer (and other similar Pugmill equipment)

GROUP 5: Cast-in-place pipe laying machine; Combination slusher and motor operator; Concrete conveyor or concrete pump, truck or equipment mounted; Concrete conveyor, building site; Concrete pump or pumpcrete gun; Drilling equipment, Watson 2000, Texoma 700 or similar; Drilling and boring machinery, horizontal (not to apply to waterliners, wagon drills or jackhammers); Concrete mixer/all; Person and/or material hoist; Mechanical finishers (concrete) (Clary, Johnson, Bidwell Bridge Deck or similar types); Mechanical burm, curb and/or curb and gutter machine, concrete or asphalt; Mine or shaft hoist; Portable crusher; Power jumbo operator (setting slip-forms, etc., in tunnels); Screed (automatic or manual); Self-propelled compactor with dozer; Tractor with boom D6 or smaller; Trenching machine, maximum digging capacity over 5 ft. depth; Vermeer T-600B rock cutter or similar

GROUP 6: Armor-Coater (or similar); Ballast jack tamper; Boom-type backfilling machine; Assistant plant engineer; Bridge and/or gantry crane; Chemical grouting machine, truck-mounted; Chip spreading machine operator; Concrete saw (self-propelled unit on streets, highways, airports and canals); Deck engineer; Drilling equipment Texoma 600, Hughes 200 Series or similar up to and including 30 ft. m.r.c.; Drill doctor; Helicopter radio operator; Hydro-hammer or similar; Line master; Skidsteer loader, Bobcat larger than 743 series or similar (with attachments); Locomotive; Lull hi-lift or similar; Oiler, truck mounted equipment; Pavement breaker, truck-mounted, with compressor combination; Paving fabric installation and/or laying machine; Pipe bending machine (pipelines only); Pipe wrapping machine (tractor propelled and supported); Screed (except asphaltic concrete paving); Self-propelled pipeline wrapping machine; Tractor; Self-loading chipper; Concrete barrier moving machine

GROUP 7: Ballast regulator; Boom truck or dual-purpose A-frame truck, non-rotating - under 15 tons; Cary lift or similar; Combination slurry mixer and/or cleaner; Drilling equipment, 20 ft. and under m.r.c.; Firetender (hot plant); Grouting machine operator; Highline cableway signalperson; Stationary belt loader (Kolman or similar); Lift slab machine (Vagtborg and similar types); Maginnes internal full slab vibrator; Material hoist (1 drum); Mechanical trench shield; Pavement breaker with or without compressor combination; Pipe cleaning machine (tractor propelled and supported); Post driver; Roller (except asphalt); Chip Seal; Self-propelled automatically applied concrete curing machine (on streets, highways, airports and canals); Self-propelled compactor (without dozer); Signalperson; Slip-form pumps (lifting device for concrete forms); Tie spacer; Tower mobile; Trenching machine, maximum digging capacity up to and including 5 ft. depth; Truck-type loader

GROUP 8: Bit sharpener; Boiler tender; Box operator; Brakeperson; Combination mixer and compressor (shotcrete/gunite); Compressor operator; Deckhand; Fire tender; Forklift (under 20 ft.); Generator; Gunite/shotcrete equipment operator; Hydraulic monitor; Ken seal machine (or similar); Mixermobile; Oiler; Pump operator; Refrigeration plant; Reservoir-debris tug (self-propelled floating); Ross Carrier (construction site); Rotomist operator; Self-propelled tape machine; Shuttlecar; Self-propelled power sweeper operator (includes vacuum sweeper); Slusher operator; Surface heater; Switchperson; Tar pot firetender; Tugger hoist, single drum; Vacuum cooling plant; Welding machine (powered other than by electricity)

GROUP 8-A: Elevator operator; Skidsteer loader-Bobcat 743 series or smaller, and similar (without attachments); Mini excavator under 25 H.P. (backhoe-trencher); Tub grinder wood chipper

-----  
ALL CRANES AND ATTACHMENTS

GROUP 1: Clamshell and dragline over 7 cu. yds.; Crane, over 100 tons; Derrick, over 100 tons; Derrick barge pedestal-mounted, over 100 tons; Self-propelled boom-type lifting device, over 100 tons



GROUP 2: Clamshell and dragline over 1 cu. yd. up to and including 7 cu. yds.; Crane, over 45 tons up to and including 100 tons; Derrick barge, 100 tons and under; Self-propelled boom-type lifting device, over 45 tons; Tower crane

GROUP 3: Clamshell and dragline up to and including 1 cu. yd.; Cranes 45 tons and under; Self-propelled boom-type lifting device 45 tons and under;

GROUP 4: Boom Truck or dual purpose A-frame truck, non-rotating over 15 tons; Truck-mounted rotating telescopic boom type lifting device, Manitex or similar (boom truck) over 15 tons; Truck-mounted rotating telescopic boom type lifting device, Manitex or similar (boom truck) - under 15 tons;

-----  
PILEDRIVERS

GROUP 1: Derrick barge pedestal mounted over 100 tons; Clamshell over 7 cu. yds.; Self-propelled boom-type lifting device over 100 tons; Truck crane or crawler, land or barge mounted over 100 tons

GROUP 2: Derrick barge pedestal mounted 45 tons to and including 100 tons; Clamshell up to and including 7 cu. yds.; Self-propelled boom-type lifting device over 45 tons; Truck crane or crawler, land or barge mounted, over 45 tons up to and including 100 tons; Fundex F-12 hydraulic pile rig

GROUP 3: Derrick barge pedestal mounted under 45 tons; Self-propelled boom-type lifting device 45 tons and under; Skid/scow piledriver, any tonnage; Truck crane or crawler, land or barge mounted 45 tons and under

GROUP 4: Assistant operator in lieu of assistant to engineer; Forklift, 10 tons and over; Heavy-duty repairperson/welder

GROUP 5: Deck engineer

GROUP 6: Deckhand; Fire tender  
-----

STEEL ERECTORS

GROUP 1: Crane over 100 tons; Derrick over 100 tons; Self-propelled boom-type lifting device over 100 tons

GROUP 2: Crane over 45 tons to 100 tons; Derrick under 100 tons; Self-propelled boom-type lifting device over 45 tons to 100 tons; Tower crane

GROUP 3: Crane, 45 tons and under; Self-propelled boom-type lifting device, 45 tons and under

GROUP 4: Chicago boom; Forklift, 10 tons and over; Heavy-duty repair person/welder

GROUP 5: Boom cat  
-----  
--

TUNNEL AND UNDERGROUND WORK

GROUP 1-A: Tunnel bore machine operator, 20' diameter or more

GROUP 1: Heading shield operator; Heavy-duty repairperson; Mucking machine (rubber tired, rail or track type); Raised bore operator (tunnels); Tunnel mole bore operator

GROUP 2: Combination slusher and motor operator; Concrete pump or pumpcrete gun; Power jumbo operator

GROUP 3: Drill doctor; Mine or shaft hoist

GROUP 4: Combination slurry mixer cleaner; Grouting Machine operator; Motorman

GROUP 5: Bit Sharpener; Brakeman; Combination mixer and compressor (gunite); Compressor operator; Oiler; Pump operator; Slusher operator  
-----

AREA DESCRIPTIONS:

POWER EQUIPMENT OPERATORS, CRANES AND ATTACHMENTS, TUNNEL AND UNDERGROUND [These areas do not apply to Piledrivers and Steel Erectors]

AREA 1: DEL NORTE, HUMBOLDT, LAKE, MENDOCINO  
AREA 2 -NOTED BELOW

THE REMAINING COUNTIES ARE SPLIT BETWEEN AREA 1 AND AREA 2 AS NOTED BELOW:

DEL NORTE COUNTY:  
Area 1: Extreme Southwest corner  
Area 2: Remainder

HUMBOLDT COUNTY:  
Area 1: Except Eastern and Southwestern parts  
Area 2: Remainder

LAKE COUNTY:  
Area 1: Southern part  
Area 2: Remainder

MENDOCINO COUNTY:  
Area 1: Central and Southeastern Parts  
Area 2: Remainder

-----  
ENGI0003-019 06/29/2020

SEE AREA DESCRIPTIONS BELOW

	Rates	Fringes
OPERATOR: Power Equipment (LANDSCAPE WORK ONLY)		
GROUP 1		
AREA 1.....	\$ 39.95	30.28
AREA 2.....	\$ 41.95	30.28
GROUP 2		
AREA 1.....	\$ 36.35	30.28
AREA 2.....	\$ 38.35	30.28
GROUP 3		
AREA 1.....	\$ 31.74	30.28
AREA 2.....	\$ 33.74	30.28

GROUP DESCRIPTIONS:

GROUP 1: Landscape Finish Grade Operator: All finish grade work regardless of equipment used, and all equipment with a rating more than 65 HP.

GROUP 2: Landscape Operator up to 65 HP: All equipment with a manufacturer's rating of 65 HP or less except equipment covered by Group 1 or Group 3. The following equipment shall be included except when used for finish work as long as manufacturer's rating is 65 HP or less: A-Frame and Winch Truck, Backhoe, Forklift, Hydragraphic Seeder Machine, Roller, Rubber-Tired and Track Earthmoving Equipment, Skiploader, Straw Blowers, and Trencher 31 HP up to 65 HP.

GROUP 3: Landscape Utility Operator: Small Rubber-Tired Tractor, Trencher Under 31 HP.

AREA DESCRIPTIONS:

AREA 1: ALAMEDA, BUTTE, CONTRA COSTA, KINGS, MARIN, MERCED, NAPA, SACRAMENTO, SAN BENITO, SAN FRANCISCO, SAN JOAQUIN, SAN MATEO, SANTA CLARA, SANTA CRUZ, SOLANO, STANISLAUS, SUTTER, YOLO, AND YUBA COUNTIES

AREA 2 - MODOC COUNTY

THE REMAINING COUNTIES ARE SPLIT BETWEEN AREA 1 AND AREA 2 AS NOTED BELOW:

ALPINE COUNTY:  
Area 1: Northernmost part  
Area 2: Remainder

CALAVERAS COUNTY:  
Area 1: Except Eastern part  
Area 2: Eastern part

COLUSA COUNTY:  
Area 1: Eastern part  
Area 2: Remainder

DEL NORTE COUNTY:  
Area 1: Extreme Southwestern corner  
Area 2: Remainder

ELDORADO COUNTY:  
Area 1: North Central part  
Area 2: Remainder

FRESNO COUNTY

Area 1: Except Eastern part  
Area 2: Eastern part

GLENN COUNTY:  
Area 1: Eastern part  
Area 2: Remainder

HUMBOLDT COUNTY:  
Area 1: Except Eastern and Southwestern parts  
Area 2: Remainder

LAKE COUNTY:  
Area 1: Southern part  
Area 2: Remainder

LASSEN COUNTY:  
Area 1: Western part along the Southern portion of border  
with Shasta County  
Area 2: Remainder

MADERA COUNTY  
Area 1: Remainder  
Area 2: Eastern part

MARIPOSA COUNTY  
Area 1: Remainder  
Area 2: Eastern part

MENDOCINO COUNTY:  
Area 1: Central and Southeastern parts  
Area 2: Remainder

MONTEREY COUNTY  
Area 1: Remainder  
Area 2: Southwestern part

NEVADA COUNTY:  
Area 1: All but the Northern portion along the border of  
Sierra County  
Area 2: Remainder

PLACER COUNTY:  
Area 1: All but the Central portion  
Area 2: Remainder

PLUMAS COUNTY:  
Area 1: Western portion  
Area 2: Remainder

SHASTA COUNTY:  
Area 1: All but the Northeastern corner  
Area 2: Remainder

SIERRA COUNTY:  
Area 1: Western part  
Area 2: Remainder

SISKIYOU COUNTY:  
Area 1: Central part  
Area 2: Remainder

SONOMA COUNTY:  
Area 1: All but the Northwestern corner  
Area 2: Reaminder

TEHAMA COUNTY:  
Area 1: All but the Western border with mendocino & Trinity  
Counties  
Area 2: Remainder

TRINITY COUNTY:  
Area 1: East Central part and the Northeaster border with  
Shasta County  
Area 2: Remainder

TULARE COUNTY;  
Area 1: Remainder  
Area 2: Eastern part

TUOLUMNE COUNTY:  
Area 1: Remainder  
Area 2: Eastern Part

-----  
IRON0433-006 07/01/2020

	Rates	Fringes
IRONWORKER		
Fence Erector.....	\$ 34.58	24.81
Ornamental, Reinforcing and Structural.....	\$ 41.00	33.45

PREMIUM PAY:

\$6.00 additional per hour at the following locations:

China Lake Naval Test Station, Chocolate Mountains Naval Reserve-Niland, Edwards AFB, Fort Irwin Military Station, Fort Irwin Training Center-Goldstone, San Clemente Island, San Nicholas Island, Susanville Federal Prison, 29 Palms - Marine Corps, U.S. Marine Base - Barstow, U.S. Naval Air Facility - Sealey, Vandenberg AFB

\$4.00 additional per hour at the following locations:

Army Defense Language Institute - Monterey, Fallon Air Base, Naval Post Graduate School - Monterey, Yermo Marine Corps Logistics Center

\$2.00 additional per hour at the following locations:

Port Hueneme, Port Mugu, U.S. Coast Guard Station - Two Rock

-----  
LAB00067-002 06/29/2020

AREA "A" - ALAMEDA, CONTRA COSTA, SAN FRANCISCO, SAN MATEO AND SANTA CLARA COUNTIES

AREA "B" - CALAVERAS, FRESNO, KINGS, MADERA, MARIPOSA, MERCED, MONTEREY, SAN BENITO, SAN JOAQUIN, STANISLAUS, AND TUOLUMNE COUNTIES

	Rates	Fringes
Asbestos Removal Laborer		
All Counties.....	\$ 25.05	12.00
LABORER (Lead Removal)		
Area A.....	\$ 33.07	25.30
Area B.....	\$ 32.07	25.30

ASBESTOS REMOVAL-SCOPE OF WORK: Site mobilization; initial site clean-up; site preparation; removal of asbestos-containing materials from walls and ceilings; or from pipes, boilers and mechanical systems only if they are being scrapped; encapsulation, enclosure and disposal of asbestos-containing materials by hand or with equipment or machinery; scaffolding; fabrication of temporary wooden barriers; and assembly of decontamination stations.

-----  
LAB00261-006 07/01/2020

MARIN COUNTY

	Rates	Fringes
LABORER		
Mason Tender-Brick.....	\$ 34.09	23.71

FOOTNOTE: Refractory work where heat-protective clothing is required: \$2.00 per hour additional.

-----  
LAB00324-003 06/25/2018

DEL NORTE, HUMBOLDT, LAKE, AND MENDOCINO COUNTIES

	Rates	Fringes
LABORER (TRAFFIC CONTROL/LANE CLOSURE)		
Escort Driver, Flag Person..	\$ 29.54	23.65
Traffic Control Person I....	\$ 29.84	23.65
Traffic Control Person II...\$	27.34	23.65

TRAFFIC CONTROL PERSON I: Layout of traffic control, crash cushions, construction area and roadside signage.

TRAFFIC CONTROL PERSON II: Installation and removal of temporary/permanent signs, markers, delineators and crash cushions.

-----  
LAB00324-005 06/25/2018

	Rates	Fringes
Laborers: (CONSTRUCTION CRAFT LABORERS)		
Construction Specialist		
Group.....	\$ 30.49	23.20
GROUP 1.....	\$ 29.79	23.20
GROUP 1-a.....	\$ 30.01	23.20
GROUP 1-c.....	\$ 29.84	23.20

GROUP 1-e.....	\$ 30.34	23.20
GROUP 1-f.....	\$ 29.37	23.20
GROUP 2.....	\$ 29.64	23.20
GROUP 3.....	\$ 29.54	23.20
GROUP 4.....	\$ 23.23	23.20
See groups 1-b and 1-d under laborer classifications		
Laborers: (GUNITE)		
GROUP 1.....	\$ 28.35	18.66
GROUP 2.....	\$ 27.85	18.66
GROUP 3.....	\$ 27.26	18.66
GROUP 4.....	\$ 27.14	18.66
Laborers: (WRECKING)		
GROUP 1.....	\$ 29.79	23.20
GROUP 2.....	\$ 29.64	23.20
Landscape Laborer (Gardeners, Horticultural & Landscape Laborers)		
Establishment Warranty Period.....	\$ 23.23	23.20
New Construction.....	\$ 29.54	23.20

FOOTNOTES:  
Laborers working off or with or from bos'n chairs, swinging scaffolds, belts (not applicable to workers entitled to receive the wage rate set forth in Group 1-a): \$0.25 per hour additional.

LABORER CLASSIFICATIONS

CONSTRUCTION SPECIALIST GROUP: Asphalt ironer and raker; Chainsaw; Laser beam in connection with laborers' work; Masonry and plasterer tender; Cast-in-place manhole form setter; Pressure pipelayer; Davis trencher - 300 or similar type (and all small trenchers); Blaster; Diamond driller; Multiple unit drill; Hydraulic drill

GROUP 1: Asphalt spreader boxes (all types); Barko, Wacker and similar type tampers; Buggymobile; Caulker, bander, pipewrapper, conduit layer, plastic pipelayer; Certified hazardous waste worker; Compactors of all types; Concrete and magnesite mixer, 1/2 yd. and under; Concrete pan work; Concrete sander; Concrete saw; Cribber and/or shoring; Cut granite curb setter; Dri-pak-it machine; Faller, logloader and bucket; Form raiser, slip forms; Green cutter; Headerboard, Hubsetter, aligner, by any method; High pressure blow pipe (1-1/2" or over, 100 lbs. pressure/over); Hydro seeder and similar ype; Jackhammer operator; Jacking of pipe over 12 inches; Jackson and similar type compactor; Kettle tender, pot and worker applying asphalt, lay-kold, creosote, lime, caustic and similar type materials (applying means applying, dipping or handling of such materials); Lagging, sheeting, whaling, bracing, trenchjacking, lagging hammer; Magnesite, epoxyresin, fiberglass, mastic worker (wet or dry); No joint pipe and stripping of same, including repair of voids; Pavement breaker and spader, including tool grinder; Perma curb; Pipelayer (including grade checking in connection with pipelaying); Precast-manhole setter; Pressure pipe tester; Post hole digger, air, gas and electric; Power broom sweeper; Power tampers of all types (except as shown in Group 2); Ram set gun and stud gun; Riprap stonepaver and rock-slinger, including placing of sacked concrete and/or sand (wet or dry) and gabions and similar type; Rotary scarifier or multiple head concrete chipping scarifier; Roto and Ditch Witch; Rototiller; Sandblaster, pot, gun, nozzle operators; Signalling and rigging; Tank cleaner; Tree climber; Turbo blaster; Vibrascreed, bull float in connection with laborers' work; Vibrator

GROUP 1-a: Joy drill model TwM-2A; Gardner-Denver model DH143 and similar type drills; Track driller; Jack leg driller; Wagon driller; Mechanical drillers, all types regardless of type or method of power; Mechanical pipe layers, all types regardless of type or method of power; Blaster and powder; All work of loading, placing and blasting of all powder and explosives of whatever type regardless of method used for such loading and placing; High scalers (including drilling of same); Tree topper; Bit grinder

GROUP 1-b: Sewer cleaners shall receive \$4.00 per day above Group 1 wage rates. "Sewer cleaner" means any worker who handles or comes in contact with raw sewage in small diameter sewers. Those who work inside recently active, large diameter sewers, and all recently active sewer manholes, shall receive \$5.00 per day above Group 1 wage rates.

GROUP 1-c: Burning and welding in connection with laborers' work; Synthetic thermoplastics and similar type welding

GROUP 1-d: Maintenance and repair track and road beds (underground structures). All employees performing work covered herein shall receive \$ .25 per hour above their

regular rate for all work performed on underground structures not specifically covered herein. This paragraph shall not be construed to apply to work below ground level in open cut. It shall apply to cut and cover work of subway construction after the temporary cover has been placed.

GROUP 1-e: Work on and/or in bell hole footings and shafts thereof, and work on and in deep footings. (A deep footing is a hole 15 feet or more in depth.) In the event the depth of the footing is unknown at the commencement of excavation, and the final depth exceeds 15 feet, the deep footing wage rate would apply to all employees for each and every day worked on or in the excavation of the footing from the date of inception.

GROUP 1-f: Wire winding machine in connection with guniting or shot crete

GROUP 2: Asphalt shoveler; Cement dumper and handling dry cement or gypsum; Choke-setter and rigger (clearing work); Concrete bucket dumper and chute; Concrete chipping and grinding; Concrete laborer (wet or dry); Driller tender, chuck tender, nipper; Guinea chaser (stake), grout crew; High pressure nozzle, adductor; Hydraulic monitor (over 100 lbs. pressure); Loading and unloading, carrying and hauling of all rods and materials for use in reinforcing concrete construction; Pittsburgh chipper and similar type brush shredders; Sloper; Single foot, hand-held, pneumatic tamper; All pneumatic, air, gas and electric tools not listed in Groups 1 through 1-f; Jacking of pipe - under 12 inches

GROUP 3: Construction laborers, including bridge and general laborer; Dump, load spotter; Flag person; Fire watcher; Fence erector; Guardrail erector; Gardener, horticultural and landscape laborer; Jetting; Limber, brush loader and piler; Pavement marker (button setter); Maintenance, repair track and road beds; Streetcar and railroad construction track laborer; Temporary air and water lines, Victaulic or similar; Tool room attendant (jobsite only)

GROUP 4: All clean-up work of debris, grounds and building including but not limited to: street cleaner; cleaning and washing windows; brick cleaner (jobsite only); material cleaner (jobsite only). The classification "material cleaner" is to be utilized under the following conditions:

- A: at demolition site for the salvage of the material.
  - B: at the conclusion of a job where the material is to be salvaged and stocked to be reused on another job.
  - C: for the cleaning of salvage material at the jobsite or temporary jobsite yard.
- The material cleaner classification should not be used in the performance of "form stripping, cleaning and oiling and moving to the next point of erection".

GUNITE LABORER CLASSIFICATIONS

GROUP 1: Structural Nozzleman

GROUP 2: Nozzleman, Gunman, Potman, Groundman

GROUP 3: Reboundman

GROUP 4: Gunit laborer

WRECKING WORK LABORER CLASSIFICATIONS

GROUP 1: Skilled wrecker (removing and salvaging of sash, windows and materials)

GROUP 2: Semi-skilled wrecker (salvaging of other building materials)

LAB00324-007 06/25/2018

DEL NORTE, HUMBOLDT, LAKE, AND MENDOCINO COUNTIES

	Rates	Fringes
Tunnel and Shaft Laborers:		
GROUP 1.....	\$ 37.82	24.11
GROUP 2.....	\$ 37.59	24.11
GROUP 3.....	\$ 37.34	24.11
GROUP 4.....	\$ 36.89	24.11
GROUP 5.....	\$ 36.35	24.11
Shotcrete Specialist.....	\$ 38.34	24.11

TUNNEL AND SHAFT CLASSIFICATIONS

GROUP 1: Diamond driller; Groundmen; Gunit and shotcrete nozzlelemen

GROUP 2: Rodmen; Shaft work & raise (below actual or excavated ground level)

GROUP 3: Bit grinder; Blaster, driller, powdermen, heading; Cherry pickermen - where car is lifted; Concrete finisher in tunnel; Concrete screedman; Grout pumpman and potman; Gunite & shotcrete gunman & potman; Headermen; High pressure nozzlelema; Miner - tunnel, including top and bottom man on shaft and raise work; Nipper; Nozzleman on slick line; Sandblaster - potman, Robotic Shotcrete Placer, Segment Erector, Tunnel Muck Hauler, Steel Form raiser and setter; Timberman, retimberman (wood or steel or substitute materials therefore); Tugger (for tunnel laborer work); Cable tender; Chuck tender; Powderman - primer house

GROUP 4: Vibrator operator, pavement breaker; Bull gang - muckers, trackmen; Concrete crew - includes rodding and spreading, Dumpmen (any method)

GROUP 5: Grout crew; Reboundman; Swamper/ Brakeman

LABO0324-009 07/01/2018

DEL NORTE, HUMBOLDT, LAKE, MENDOCINO, NAPA, SOLANO, AND SONOMA COUNTIES

	Rates	Fringes
LABORER		
Mason Tender-Brick.....	\$ 31.45	22.20

FOOTNOTE: Refractory work where heat-protective clothing is required: \$2.00 per hour additional.

PAIN0016-021 01/01/2021

LAKE AND MENDOCINO COUNTIES

	Rates	Fringes
Painters:.....	\$ 45.22	25.48

PAIN1034-001 06/01/1993

DEL NORTE AND HUMBOLDT COUNTIES

	Rates	Fringes
Painters:		
Brush & Roller.....	\$ 13.35	2.94
Sandblaster, spray, structural steel & swing stage.....	\$ 13.60	2.94

PAIN1176-001 07/01/2020

HIGHWAY IMPROVEMENT

	Rates	Fringes
Parking Lot Striping/Highway Marking:		
GROUP 1.....	\$ 38.48	16.88
GROUP 2.....	\$ 32.71	16.88
GROUP 3.....	\$ 33.09	16.88

CLASSIFICATIONS

GROUP 1: Striper: Layout and application of painted traffic stripes and marking; hot thermo plastic; tape, traffic stripes and markings

GROUP 2: Gamecourt & Playground Installer

GROUP 3: Protective Coating, Pavement Sealing

PLAS0300-005 07/01/2017

	Rates	Fringes
CEMENT MASON/CONCRETE FINISHER...	\$ 33.49	23.67

PLUM0038-004 07/01/2020

LAKE AND MENDOCINO COUNTIES

	Rates	Fringes
Landscape/Irrigation Fitter (Underground/Utility Fitter).....	\$ 63.04	31.48

PLUMBER

Work on wooden frame structures 5 stories or less excluding high-rise buildings and commercial work such as hospitals, prisons, hotels, schools, casinos, wastewater treatment plants, and research facilities as well as refrigeration pipefitting, service and repair work - MARKET

RECOVERY RATE.....\$ 64.86	43.54
All other work - NEW CONSTRUCTION RATE.....\$ 76.30	45.27

-----  
PLUM0355-005 07/01/2020

DEL NORTE AND HUMBOLDT COUNTIES:

	Rates	Fringes
Underground Utility Worker /Landscape Fitter.....\$ 29.90		16.30

-----  
SHEE0104-016 06/29/2020

	Rates	Fringes
SHEET METAL WORKER Mechanical contracts \$200,000 or less.....\$ 55.92		45.29
All other work.....\$ 64.06		46.83

-----  
\* TEAM0094-001 07/01/2019

	Rates	Fringes
Truck drivers:		
GROUP 1.....\$ 32.80		29.19
GROUP 2.....\$ 33.10		29.19
GROUP 3.....\$ 33.40		29.19
GROUP 4.....\$ 33.75		29.19
GROUP 5.....\$ 34.10		29.19

FOOTNOTES:

Articulated dump truck; Bulk cement spreader (with or without auger); Dumpcrete truck; Skid truck (debris box); Dry pre-batch concrete mix trucks; Dumpster or similar type; Slurry truck: Use dump truck yardage rate.  
Heater planer; Asphalt burner; Scarifier burner; Industrial lift truck (mechanical tailgate); Utility and clean-up truck: Use appropriate rate for the power unit or the equipment utilized.

TRUCK DRIVER CLASSIFICATIONS

GROUP 1: Dump trucks, under 6 yds.; Single unit flat rack (2-axle unit); Nipper truck (when flat rack truck is used appropriate flat rack shall apply); Concrete pump truck (when flat rack truck is used appropriate flat rack shall apply); Concrete pump machine; Fork lift and lift jitneys; Fuel and/or grease truck driver or fuel person; Snow buggy; Steam cleaning; Bus or personhaul driver; Escort or pilot car driver; Pickup truck; Teamster oiler/greaser and/or serviceperson; Hook tender (including loading and unloading); Team driver; Tool room attendant (refineries)

GROUP 2: Dump trucks, 6 yds. and under 8 yds.; Transit mixers, through 10 yds.; Water trucks, under 7,000 gals.; Jetting trucks, under 7,000 gals.; Single-unit flat rack (3-axle unit); Highbed heavy duty transport; Scissor truck; Rubber-tired muck car (not self-loaded); Rubber-tired truck jumbo; Winch truck and "A" frame drivers; Combination winch truck with hoist; Road oil truck or bootperson; Buggymobile; Ross, Hyster and similar straddle carriers; Small rubber-tired tractor

GROUP 3: Dump trucks, 8 yds. and including 24 yds.; Transit mixers, over 10 yds.; Water trucks, 7,000 gals. and over; Jetting trucks, 7,000 gals. and over; Vacuum trucks under 7500 gals. Trucks towing tilt bed or flat bed pull trailers; Lowbed heavy duty transport; Heavy duty transport tiller person; Self-propelled street sweeper with self-contained refuse bin; Boom truck - hydro-lift or Swedish type extension or retracting crane; P.B. or similar type self-loading truck; Tire repairperson; Combination bootperson and road oiler; Dry distribution truck (A bootperson when employed on such equipment, shall receive the rate specified for the classification of road oil trucks or bootperson); Ammonia nitrate distributor, driver and mixer; Snow Go and/or plow



GROUP 4: Dump trucks, over 25 yds. and under 65 yds.; Water pulls - DW 10's, 20's, 21's and other similar equipment when pulling Aqua/pak or water tank trailers; Helicopter pilots (when transporting men and materials); Lowbed Heavy Duty Transport up to including 7 axles; DW10's, 20's, 21's and other similar Cat type, Terra Cobra, LeTourneau Pulls, Tournorocker, Euclid and similar type equipment when pulling fuel and/or grease tank trailers or other miscellaneous trailers; Vacuum Trucks 7500 gals and over and truck repairman

GROUP 5: Dump trucks, 65 yds. and over; Holland hauler; Low bed Heavy Duty Transport over 7 axles

-----  
WELDERS - Receive rate prescribed for craft performing operation to which welding is incidental.  
=====

Note: Executive Order (EO) 13706, Establishing Paid Sick Leave for Federal Contractors applies to all contracts subject to the Davis-Bacon Act for which the contract is awarded (and any solicitation was issued) on or after January 1, 2017. If this contract is covered by the EO, the contractor must provide employees with 1 hour of paid sick leave for every 30 hours they work, up to 56 hours of paid sick leave each year. Employees must be permitted to use paid sick leave for their own illness, injury or other health-related needs, including preventive care; to assist a family member (or person who is like family to the employee) who is ill, injured, or has other health-related needs, including preventive care; or for reasons resulting from, or to assist a family member (or person who is like family to the employee) who is a victim of, domestic violence, sexual assault, or stalking. Additional information on contractor requirements and worker protections under the EO is available at [www.dol.gov/whd/govcontracts](http://www.dol.gov/whd/govcontracts).

Unlisted classifications needed for work not included within the scope of the classifications listed may be added after award only as provided in the labor standards contract clauses (29CFR 5.5 (a) (1) (ii)).

-----  
The body of each wage determination lists the classification and wage rates that have been found to be prevailing for the cited type(s) of construction in the area covered by the wage determination. The classifications are listed in alphabetical order of "identifiers" that indicate whether the particular rate is a union rate (current union negotiated rate for local), a survey rate (weighted average rate) or a union average rate (weighted union average rate).

Union Rate Identifiers

A four letter classification abbreviation identifier enclosed in dotted lines beginning with characters other than "SU" or "UAVG" denotes that the union classification and rate were prevailing for that classification in the survey. Example: PLUM0198-005 07/01/2014. PLUM is an abbreviation identifier of the union which prevailed in the survey for this classification, which in this example would be Plumbers. 0198 indicates the local union number or district council number where applicable, i.e., Plumbers Local 0198. The next number, 005 in the example, is an internal number used in processing the wage determination. 07/01/2014 is the effective date of the most current negotiated rate, which in this example is July 1, 2014.

Union prevailing wage rates are updated to reflect all rate changes in the collective bargaining agreement (CBA) governing this classification and rate.

Survey Rate Identifiers

Classifications listed under the "SU" identifier indicate that no one rate prevailed for this classification in the survey and the published rate is derived by computing a weighted average rate based on all the rates reported in the survey for that classification. As this weighted average rate includes all rates reported in the survey, it may include both union and non-union rates. Example: SULA2012-007 5/13/2014. SU indicates the rates are survey rates based on a weighted average calculation of rates and are not majority rates. LA indicates the State of Louisiana. 2012 is the year of survey on which these classifications and rates are based. The next number, 007 in the example, is an internal number used in producing the wage determination. 5/13/2014 indicates the survey completion date for the classifications and rates under that identifier.

Survey wage rates are not updated and remain in effect until a new survey is conducted.

#### Union Average Rate Identifiers

Classification(s) listed under the UAVG identifier indicate that no single majority rate prevailed for those classifications; however, 100% of the data reported for the classifications was union data. EXAMPLE: UAVG-OH-0010 08/29/2014. UAVG indicates that the rate is a weighted union average rate. OH indicates the state. The next number, 0010 in the example, is an internal number used in producing the wage determination. 08/29/2014 indicates the survey completion date for the classifications and rates under that identifier.

A UAVG rate will be updated once a year, usually in January of each year, to reflect a weighted average of the current negotiated/CBA rate of the union locals from which the rate is based.

---

#### WAGE DETERMINATION APPEALS PROCESS

1.) Has there been an initial decision in the matter? This can be:

- \* an existing published wage determination
- \* a survey underlying a wage determination
- \* a Wage and Hour Division letter setting forth a position on a wage determination matter
- \* a conformance (additional classification and rate) ruling

On survey related matters, initial contact, including requests for summaries of surveys, should be with the Wage and Hour Regional Office for the area in which the survey was conducted because those Regional Offices have responsibility for the Davis-Bacon survey program. If the response from this initial contact is not satisfactory, then the process described in 2.) and 3.) should be followed.

With regard to any other matter not yet ripe for the formal process described here, initial contact should be with the Branch of Construction Wage Determinations. Write to:

Branch of Construction Wage Determinations  
Wage and Hour Division  
U.S. Department of Labor  
200 Constitution Avenue, N.W.  
Washington, DC 20210

2.) If the answer to the question in 1.) is yes, then an interested party (those affected by the action) can request review and reconsideration from the Wage and Hour Administrator (See 29 CFR Part 1.8 and 29 CFR Part 7). Write to:

Wage and Hour Administrator  
U.S. Department of Labor  
200 Constitution Avenue, N.W.  
Washington, DC 20210

The request should be accompanied by a full statement of the interested party's position and by any information (wage payment data, project description, area practice material, etc.) that the requestor considers relevant to the issue.

3.) If the decision of the Administrator is not favorable, an interested party may appeal directly to the Administrative Review Board (formerly the Wage Appeals Board). Write to:

Administrative Review Board  
U.S. Department of Labor  
200 Constitution Avenue, N.W.  
Washington, DC 20210

4.) All decisions by the Administrative Review Board are final.

---

END OF GENERAL DECISION"

HUMBOLDT COUNTY DEPARTMENT OF PUBLIC WORKS

Sheet 1 of 3**CONTRACT CHANGE ORDER**Change Requested by: Engineer  Contractor 

CCO No.	Suppl. No.	Contract No.	Road	Federal Number(s)
1	0	217288 (PM 21.8-23.05)	Alderpoint Road (F6B165)	ER-32L0(329)

To: Granite Construction Company, Contractor

You are directed to make the following changes from the plans and specifications or do the following described work not included in the plans and specifications for this contract. **NOTE: This change order is not effective until approved by the Engineer**

Description of work to be done, estimate of quantities and prices to be paid. (Segregate between additional work at contract price, agreed price and force account.) Unless otherwise stated, rates for rental of equipment cover only such time as equipment is actually used and no allowance will be made for idle time. The last percentage shown is the net accumulated increase or decrease from the original quantity in the Engineer's Estimate

Project locations PM 22.8-23.05: **1)** Increase the authorized quantities of the following items of work due to normal quantity overruns associated with the planned construction and adjustments to fit field conditions: Item No. 10, Storm Water Sampling and Analysis Day; Item No. 27, Class 2 Aggregate Base; Item No. 28, Hot Mix Asphalt (Type A); Item No. 37, 18" Corrugated Steel Pipe (0.064" Thick); Item No. 39, 30" Corrugated Steel Pipe (0.064" Thick); Item No. 41, 6" Perforated Plastic Pipe Underdrain; Item No. 43, Filter Fabric; and Item No. 57, Thermoplastic Traffic Stripe (Sprayable). **2)** Decrease the authorized quantities of the following items of work due to normal quantity underruns associated with the planned construction and adjustments to fit field conditions: Item No. 9, Rain Event Action Plan and Item No. 40, Cleanout Assembly. **3)** Provide compensation for authorized extra work. **4)** Provide a contract time extension.

**1) Increase in Bid Item at Bid Item Price:**

Item No. 10, Storm Water Sampling and Analysis Day  
10 EA (166.7%) @ \$250.00 / EA = \$2,500.00 (+166.7%)

Item No. 27, Class 2 Aggregate Base  
220.0 CY (29.6%) @ \$140.00 / CY = \$30,800.00 (+29.6%)

Item No. 28, Hot Mix Asphalt (Type A)  
233.0 Ton (28.9%) @ \$235.00 / Ton = \$54,755.00 (+28.9%)

Item No. 37, 18" Corrugated Steel Pipe (0.064" Thick)  
101.0 LF (37.4%) @ \$155.00 / LF = \$15,655.00 (+37.4%)

Item No. 39, 30" Corrugated Steel Pipe (0.064" Thick)  
18.0 LF (29.0%) @ \$255.00 / LF = \$4,590.00 (+29.0%)

Item No. 41, 6" Perforated Plastic Pipe Underdrain  
565.0 LF (54.5%) @ \$65.00 / LF = \$36,725.00 (+54.5%)

Item No. 43, Filter Fabric  
300.0 SY (8.5%) @ \$1.50 / SY = \$450.00 (+8.5%)

Item No. 57, Thermoplastic Traffic Stripe (Sprayable)  
600.0 LF (51.7%) @ \$3.50 / LF = \$2,100.00 (+51.7%)

Total Increase: \$147,575.00

There shall be no adjustment of the contract unit price for Item No. 10, 27, 28, 37, 39, 41, and 57 in accordance with Section 9-1.06B, "Increases of More Than 25 Percent," of the Standard Specifications.

HUMBOLDT COUNTY DEPARTMENT OF PUBLIC WORKS

Sheet 2 of 3**CONTRACT CHANGE ORDER**Change Requested by: Engineer  Contractor 

CCO No.	Suppl. No.	Contract No.	Road	Federal Number(s)
1	0	217288 (PM 21.8-23.05)	Alderpoint Road (F6B165)	ER-32L0(329)

To: Granite Construction Company, Contractor

You are directed to make the following changes from the plans and specifications or do the following described work not included in the plans and specifications for this contract. **NOTE: This change order is not effective until approved by the Engineer.**

Description of work to be done, estimate of quantities and prices to be paid. (Segregate between additional work at contract price, agreed price and force account.) Unless otherwise stated, rates for rental of equipment cover only such time as equipment is actually used and no allowance will be made for idle time. The last percentage shown is the net accumulated increase or decrease from the original quantity in the Engineer's Estimate

**2) Decrease in Bid Item at Bid Item Price:**

Item No. 9, Rain Event Action Plan  
10 EA (50%) @ \$500.00 / EA = \$5,000.00 (-50%)

Item No. 40, Cleanout Assembly  
9.0 EA (100%) @ \$2,950.00 / EA = \$26,550.00 (-100%)

Total Decrease: (\$31,550.00)

There shall be no adjustment of the contract unit price for Item No. 9 in accordance with Section 9-1.06C, "Decrease of More Than 25 Percent," of the Standard Specifications.

In accordance with the provisions of Section 9-1.06D, Eliminated Items, of the Standard Specifications, the adjustment due to the elimination of Item No. 40 is zero since no costs were incurred.

**3) Extra Work at Agreed Lump Sum Price:**

In accordance with the provisions of Section 4-1.05, Changes and Extra Work, and Section 9-1.04, Force Account, of the Standard Specifications, provide compensation for the following work authorized by the Engineer:

- PM 22.8: Construct rock overside drain; Adjust position of drainage inlet; Remove and replace unsuitable material encountered in the planned excavation; and Adjust positions of culvert downdrain outlet to fit field conditions.
- PM 23.0-23.05: Remove unsuitable material encountered in planned excavation and replace or mix with County furnished Riverrun material; Place shoulder backing in areas where the HMA surfacing limits were extended; and Adjust position of drainage inlet to fit field conditions.

For this specified work, the Contractor agrees to accept a lump sum payment of **\$66,665.70**. This sum shall constitute full compensation for the work, complete in-place, including all markups.

**4) Time Adjustment:**

Based on a time impact analysis (TIA), a determination of the delay in completion of the contract due to the work specified Contract Change Order No. 1 has been made in accordance with Sections 4-1.05, Changes and Extra Work, and 8-1.07B, Time Adjustments, of the Standard Specifications. A six (6) working day extension is granted.

The work specified in Change Order No. 1 delayed the controlling operation and completion of the contract by a period of six (6) working days which include the following dates: September 1-2, 2021; September 23, 2021; September 30, 2021; and October 7-8, 2021.

HUMBOLDT COUNTY DEPARTMENT OF PUBLIC WORKS

Sheet 3 of 3**CONTRACT CHANGE ORDER**Change Requested by: Engineer  Contractor 

CCO No.	Suppl. No.	Contract No.	Road	Federal Number(s)
1	0	217288 (PM 21.8-23.05)	Alderpoint Road (F6B165)	ER-32L0(329)

To: Granite Construction Company, Contractor

You are directed to make the following changes from the plans and specifications or do the following described work not included in the plans and specifications for this contract. **NOTE: This change order is not effective until approved by the Engineer.**

Description of work to be done, estimate of quantities and prices to be paid. (Segregate between additional work at contract price, agreed price and force account.) Unless otherwise stated, rates for rental of equipment cover only such time as equipment is actually used and no allowance will be made for idle time. The last percentage shown is the net accumulated increase or decrease from the original quantity in the Engineer's Estimate

No Additional Text in This Section.

Estimated Cost: Decrease  Increase  \$ 182,690.70By reason of this order the time of completion will be adjusted as follows: **SIX (6) WORKING DAY EXTENSION**

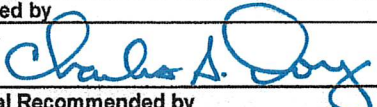
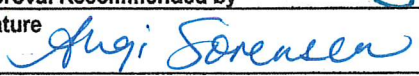
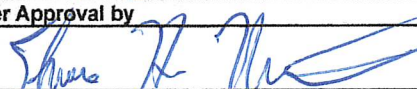
Submitted by		
Signature	(Print name & title)	Date
	Charles A. Dory, P.E., Resident Engineer	3/5/2022
Approval Recommended by		
Signature	(Print name & title)	Date
	Angi Sorensen, P.E., Assoc. Civil Engineer	4/20/22
Engineer Approval by		
Signature	(Print name & title)	Date
	Thomas K. Mattson, P.E., Director of Public Works	4/20/22

We the undersigned contractor, have given careful consideration to the change proposed and agree, if this proposal is approved, that we will provide all equipment, furnish the materials, except as may otherwise be noted above, and perform all services necessary for the work above specified, and will accept as full payment therefor the prices shown above. **NOTE: If you, the contractor, do not sign acceptance of this order, your attention is directed to the requirements of the specification as to proceeding with the ordered work and filing a written protest within the time therein specified.**

Contractor Acceptance by		
Signature	(Print name & title)	Date
	Matt Storm - Construction Manager	4/4/22



CONTRACT CHANGE ORDER NUMBER	1	SUPL. NO.	1
------------------------------	---	-----------	---

DATE PREPARED BY RESIDENT ENGINEER: August 18, 2023

PROJECT NAME: STORM DAMAGE REPAIR TO ALDERPOINT ROAD AT PM 21.80, 22.80, & 23.00-23.05

PROJECT NO. ER-32L0(329) CONTRACT NO. 217288

TO: GRANITE CONSTRUCTION COMPANY, P.O. BOX 742478, LOS ANGELES, CA 90074-2478

YOU ARE HEREBY DIRECTED TO MAKE THE HEREIN DESCRIBED CHANGES FROM THE PLANS AND SPECIFICATIONS OR TO DO THE FOLLOWING DESCRIBED WORK NOT INCLUDED IN THE PLANS AND SPECIFICATIONS FOR THIS CONTRACT. NOTE THIS CHANGE ORDER IS NOT EFFECTIVE UNTIL APPROVED BY THE DIRECTOR OF PUBLIC WORKS

DESCRIPTION OF WORK TO BE DONE, ESTIMATE OF QUANTITIES, AND PRICES PAID. (SEGREGATE BETWEEN ADDITIONAL WORK AT CONTRACT PRICE, AGREED PRICE AND FORCE ACCOUNT.) UNLESS OTHERWISE STATED, RATES FOR RENTAL OF EQUIPMENT COVER ONLY SUCH TIME AS EQUIPMENT IS ACTUALLY USED AND NO ALLOWANCE WILL BE MADE FOR IDLE TIME. THE LAST PERCENTAGE SHOWN IS THE NET ACCUMULATED INCREASE OR DECREASE FROM THE ORIGINAL QUANTITY IN THE ENGINEER'S ESTIMATE.

Reconcile differences between quantities authorized in Change Order No. 1 and installed quantities.

**INCREASE IN CONTRACT BID ITEMS AT CONTRACT BID ITEM PRICES**

ITEM NO. 57	THERMOPLASTIC TRAFFIC STRIPE (SPRAYABLE)				
	83 LF	7.16%	@	\$ 3.50 / LF	\$ 290.50
<b>TOTAL INCREASE =</b>					<b>\$ 290.50</b>

**DECREASE IN CONTRACT BID ITEMS AT CONTRACT BID ITEM PRICES**

ITEM NO. 9	RAIN EVENT ACTION PLAN				
	-5 EA	-25.00%	@	\$ 500.00 / EA	\$ (2,500.00)
ITEM NO. 27	CLASS 2 AGGREGATE BASE (CY)				
	-80.50 CY	-10.82%	@	\$ 140.00 / CY	\$ (11,270.00)
ITEM NO. 28	HOT MIX ASPHALT (TYPE A)				
	-77.02 TN	-9.57%	@	\$ 235.00 / TN	\$ (18,099.70)
ITEM NO. 37	18" CORRUGATED STEEL PIPE (0.064" TH)				
	-133 LF	-49.26%	@	\$ 155.00 / LF	\$ (20,615.00)
<b>TOTAL DECREASE =</b>					<b>\$ (52,484.70)</b>

No adjustment to contract unit price for Item No. 37, 18" Corrugated Steel Pipe (0.064" Th), will be made in accordance with Section 9-1.06C, "Decreases of More Than 25 Percent," of the *Standard Specifications* by reason of this change order.

Return \$540.00 to contingency fund by correcting clerical error in Change Order No. 1. Increase of \$4,590.00 for Item No. 39, 30" Corrugated Steel Pipe (0.064" Thick), was based on a unit price of \$255/LF. Correct unit price is \$225/LF, resulting in an authorized increase of \$4,050.00 for the quantity increase of 18 LF.

**TOTAL CORRECTION = \$ (540.00)**

A determination of the delay in completion of the project due to the work specified in this change order has been made in accordance with Section 8-1.02, Schedule, and Section 8-1.07, Delays, of the *Standard Specifications*. No time adjustment is granted because these changes did not delay controlling operations.

**ESTIMATED TOTAL DECREASE = \$ (52,734.20)**

BY REASON OF THIS CHANGE, THE CONTRACT TIME WILL BE INCREASED BY 0 WORKING DAYS

**SUBMITTED BY:**

SIGNATURE 	PRINT NAME AND TITLE ANGI SORENSEN, CONSTRUCTION ENGINEER	DATE 9/29/23
--	--	-----------------

**DIRECTOR APPROVAL BY:**

SIGNATURE 	PRINT NAME AND TITLE TOM MATTSO, DIRECTOR OF PUBLIC WORKS	DATE 9/29/23
--	--	-----------------

WE, THE UNDERSIGNED CONTRACTOR, HAVE GIVEN CAREFUL CONSIDERATION TO THIS CHANGE PROPOSED AND AGREE, IF THIS PROPOSAL IS APPROVED, THAT WE WILL PROVIDE ALL EQUIPMENT, FURNISH ALL MATERIALS, EXCEPT AS MAY OTHERWISE BE NOTED ABOVE, AND PERFORM ALL SERVICES NECESSARY FOR THE WORK ABOVE SPECIFIED, AND WILL ACCEPT AS FULL PAYMENT, THEREFORE, THE PRICES SHOWN ABOVE. NOTE: IF YOU, THE CONTRACTOR, DO NOT SIGN ACCEPTANCE OF THIS ORDER, YOUR ATTENTION IS DIRECTED TO THE REQUIREMENTS OF THE SPECIFICATION AS TO PROCEEDING WITH THE ORDERED WORK AND FILING A WRITTEN PROTEST WITHIN THE TIME THEREIN SPECIFIED.

**CONTRACTOR ACCEPTANCE BY:**

SIGNATURE 	PRINT NAME AND TITLE Matt Storm - Construction Manager	DATE 9/28/23
--	---	-----------------

Digitally signed by Matt Storm  
 Contact Info:  
 Construction Manager -  
 North Coast Area  
 Date: 2023.09.28  
 18:40:39-07'00'

HUMBOLDT COUNTY DEPARTMENT OF PUBLIC WORKS

Sheet 1 of 3**CONTRACT CHANGE ORDER**Change Requested by: Engineer  Contractor 

CCO No.	Suppl. No.	Contract No.	Road	Federal Number(s)
2	0	217288 (PM 21.8-23.05)	Alderpoint Road (F6B165)	ER-32L0(329)

To: Granite Construction Company, Contractor

You are directed to make the following changes from the plans and specifications or do the following described work not included in the plans and specifications for this contract. **NOTE: This change order is not effective until approved by the Engineer.**



Description of work to be done, estimate of quantities and prices to be paid. (Segregate between additional work at contract price, agreed price and force account.) Unless otherwise stated, rates for rental of equipment cover only such time as equipment is actually used and no allowance will be made for idle time. The last percentage shown is the net accumulated increase or decrease from the original quantity in the Engineer's Estimate

Raise the OMP drainage inlet to new roadway elevation at PM 21.8. This work was completed prior to an agreed price, and is therefore paid for at Force Account. Extra work bills 21-23 are included for payment for a total of \$12,213.53. Payment is full compensation for furnishing and activities to complete the work.

Three (3) working days are warranted for this change for days 9/8/23, 9/9/23 and 9/12/23.

Estimated Cost: Decrease  Increase  \$ 12,213.53

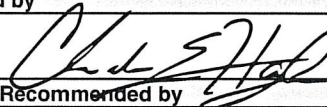
By reason of this order the time of completion will be adjusted as follows: **Three (3) WORKING DAY EXTENSION**

Submitted by		
Signature 	(Print name & title) Charlie Hayler, P.E., Resident Engineer	Date 6/1/2023
Approval Recommended by		
Signature 	(Print name & title) Angi Sorensen, P.E., Assoc. Civil Engineer	Date 7/25/23
Engineer Approval by		
Signature 	(Print name & title) Thomas K. Mattson, P.E., Director of Public Works	Date 7/25/23

We the undersigned contractor, have given careful consideration to the change proposed and agree, if this proposal is approved, that we will provide all equipment, furnish the materials, except as may otherwise be noted above, and perform all services necessary for the work above specified, and will accept as full payment therefor the prices shown above. **NOTE: If you, the contractor, do not sign acceptance of this order, your attention is directed to the requirements of the specification as to proceeding with the ordered work and filing a written protest within the time therein specified.**

Contractor Acceptance by		
Signature 	(Print name & title) Matt Storm - Construction Manger	Date 6/20/2023

Digitally signed by Matt Storm

Contact Info:

Construction Manager -  
North Coast Area  
Date: 2023.06.20  
13:20:42-07'00'

CEM-4900 (OLD HC-5 REV. 8/97)

CONTRACT CHANGE ORDER NUMBER	3	SUPPL. NO.	
------------------------------	---	------------	--

DATE PREPARED BY RESIDENT ENGINEER: August 18, 2023

PROJECT NAME: STORM DAMAGE REPAIR TO ALDERPOINT ROAD AT PM 21.80, 22.80, & 23.00-23.05

PROJECT NO. ER-32L0(329) CONTRACT NO. 217288

TO: GRANITE CONSTRUCTION COMPANY, P.O. BOX 742478, LOS ANGELES, CA 90074-2478

YOU ARE HEREBY DIRECTED TO MAKE THE HEREIN DESCRIBED CHANGES FROM THE PLANS AND SPECIFICATIONS OR TO DO THE FOLLOWING DESCRIBED WORK NOT INCLUDED IN THE PLANS AND SPECIFICATIONS FOR THIS CONTRACT. **NOTE THIS CHANGE ORDER IS NOT EFFECTIVE UNTIL APPROVED BY THE DIRECTOR OF PUBLIC WORKS**

DESCRIPTION. OF WORK TO BE DONE, ESTIMATE OF QUANTITIES, AND PRICES PAID. (SEGREGATE BETWEEN ADDITIONAL WORK AT CONTRACT PRICE, AGREED PRICE AND FORCE ACCOUNT.) UNLESS OTHERWISE STATED, RATES FOR RENTAL OF EQUIPMENT COVER ONLY SUCH TIME AS EQUIPMENT IS ACTUALLY USED AND NO ALLOWANCE WILL BE MADE FOR IDLE TIME. THE LAST PERCENTAGE SHOWN IS THE NET ACCUMULATED INCREASE OR DECREASE FROM THE ORIGINAL QUANTITY IN THE ENGINEER'S ESTIMATE.

**INCREASE IN CONTRACT BID ITEMS AT CONTRACT BID ITEM PRICES**

ITEM NO. 14	TEMPORARY SILT FENCE						
	73 LF	7.53%	@	\$	3.00 / LF	\$	219.00
ITEM NO. 18	ROADWAY EXCAVATION						
	67.1 CY	0.58%	@	\$	35.00 / CY	\$	2,348.50
ITEM NO. 33	24" DRILLED HOLE						
	31.44 LF	5.44%	@	\$	250.00 / LF	\$	7,860.00
ITEM NO. 44	CLASS 1 PERMEABLE MATERIAL						
	60 CY	2.86%	@	\$	85.00 / CY	\$	5,100.00
ITEM NO. 45	24" CORRUGATED STEEL PIPE DOWNDRAIN (0.064" TH)						
	12.00 LF	150.00%	@	\$	265.00 / LF	\$	3,180.00
ITEM NO. 49	ROCK SLOPE PROTECTION (60 LB, CLASS II, METHOD B)						
	4.07 CY	16.28%	@	\$	375.00 / CY	\$	1,526.25
ITEM NO. 54	VEGETATION CONTROL (MINOR CONCRETE)						
	6.65 SY	5.99%	@	\$	55.00 / SY	\$	365.75

**TOTAL INCREASE = \$ 20,599.50**

**DECREASE IN CONTRACT BID ITEMS AT CONTRACT BID ITEM PRICES**

ITEM NO. 4	CHANNELIZER (SURFACE MOUNTED)						
	-45 EA	-20.83%	@	\$	45.00 / EA	\$	(2,025.00)
ITEM NO. 5	TEMPORARY RAILING (TYPE K)						
	-440 LF	-30.99%	@	\$	30.00 / LF	\$	(13,200.00)
ITEM NO. 6	TEMPORARY CRASH CUSHION						
	-4 EA	-40.00%	@	\$	1,025.00 / EA	\$	(4,100.00)
ITEM NO. 12	TEMPORARY CHECK DAM						
	-360 LF	-100.00%	@	\$	11.00 / LF	\$	(3,960.00)
ITEM NO. 13	TEMPORARY DRAINAGE INLET PROTECTION						
	-1 EA	-20.00%	@	\$	62.00 / EA	\$	(62.00)
ITEM NO. 15	TEMPORARY CONSTRUCTION ENTRANCE						
	-1 EA	-50.00%	@	\$	8,425.00 / EA	\$	(8,425.00)
ITEM NO. 16	TEMPORARY CONCRETE WASHOUT						
	-1 EA	-50.00%	@	\$	580.00 / EA	\$	(580.00)



**DECREASE IN CONTRACT BID ITEMS AT CONTRACT BID ITEM PRICES (CONTINUED)**

ITEM NO. 26	FIBER ROLLS					
	-700 LF	-26.62%	@	\$ 7.68	/ LF	\$ (5,376.00)
ITEM NO. 38	24" CORRUGATED STEEL PIPE (0.064" TH)					
	-8 LF	-6.02%	@	\$ 145.00	/ LF	\$ (1,160.00)
ITEM NO. 46	18" ANCHOR ASSEMBLY					
	-1 EA	-20.00%	@	\$ 1,025.00	/ EA	\$ (1,025.00)
ITEM NO. 52	OBJECT MARKER					
	-2 EA	-100.00%	@	\$ 250.00	/ EA	\$ (500.00)

**TOTAL DECREASE = \$ (40,413.00)**

No adjustment to contract unit prices for Item No. 5, Temporary Railing (Type K); Item No. 15, Temporary Construction Entrance; and Item No. 26, Fiber Rolls, will be made in accordance with Section 9-1.06C, "Decreases of More Than 25 Percent," of the *Standard Specifications* by reason of this change order.

In accordance with Section 9-1.06D, "Eliminated Items," of the *Standard Specifications*, the adjustment due to the elimination of Item No. 12, Temporary Check Dam, and Item No. 52, Object Marker, is zero.

A determination of the delay in completion of the project due to the work specified in this change order has been made in accordance with Section 8-1.02, Schedule, and Section 8-1.07, Delays, of the *Standard Specifications*. No time adjustment is granted because these changes did not delay controlling operations.

**ESTIMATED TOTAL DECREASE = \$ (19,813.50)**

BY REASON OF THIS CHANGE, THE CONTRACT TIME WILL BE INCREASED BY 0 WORKING DAYS

**SUBMITTED BY:**

SIGNATURE 	PRINT NAME AND TITLE ANGI SORENSEN, CONSTRUCTION ENGINEER	DATE 9/28/23
--	--	-----------------

**DIRECTOR APPROVAL BY:**

SIGNATURE 	PRINT NAME AND TITLE TOM MATTSON, DIRECTOR OF PUBLIC WORKS	DATE 9/28/23
--	---	-----------------

WE, THE UNDERSIGNED CONTRACTOR, HAVE GIVEN CAREFUL CONSIDERATION TO THIS CHANGE PROPOSED AND AGREE, IF THIS PROPOSAL IS APPROVED, THAT WE WILL PROVIDE ALL EQUIPMENT, FURNISH ALL MATERIALS, EXCEPT AS MAY OTHERWISE BE NOTED ABOVE, AND PERFORM ALL SERVICES NECESSARY FOR THE WORK ABOVE SPECIFIED, AND WILL ACCEPT AS FULL PAYMENT, THEREFORE, THE PRICES SHOWN ABOVE. NOTE: IF YOU, THE CONTRACTOR, DO NOT SIGN ACCEPTANCE OF THIS ORDER, YOUR ATTENTION IS DIRECTED TO THE REQUIREMENTS OF THE SPECIFICATION AS TO PROCEEDING WITH THE ORDERED WORK AND FILING A WRITTEN PROTEST WITHIN THE TIME THEREIN SPECIFIED.

**CONTRACTOR ACCEPTANCE BY:**

SIGNATURE 	PRINT NAME AND TITLE Matt Storm - Construction Manager	DATE 9/28/2023
--	---	-------------------

Digitally signed by Matt Storm  
 Contact Info:  
 Construction Manager  
 - North Coast Area  
 Date: 2023.09.28  
 18:51:18-07'00'

CONTRACT CHANGE ORDER NUMBER	4	SUPPL. NO.	
------------------------------	---	------------	--

DATE PREPARED BY RESIDENT ENGINEER: September 28, 2023

PROJECT NAME: STORM DAMAGE REPAIR TO ALDERPOINT ROAD AT PM 21.80, 22.80, & 23.00-23.05

PROJECT NO. ER-32L0(329) CONTRACT NO. 217288

TO: GRANITE CONSTRUCTION COMPANY, P.O. BOX 742478, LOS ANGELES, CA 90074-2478

YOU ARE HEREBY DIRECTED TO MAKE THE HEREIN DESCRIBED CHANGES FROM THE PLANS AND SPECIFICATIONS OR TO DO THE FOLLOWING DESCRIBED WORK NOT INCLUDED IN THE PLANS AND SPECIFICATIONS FOR THIS CONTRACT. **NOTE THIS CHANGE ORDER IS NOT EFFECTIVE UNTIL APPROVED BY THE DIRECTOR OF PUBLIC WORKS**

DESCRIPTION OF WORK TO BE DONE, ESTIMATE OF QUANTITIES, AND PRICES PAID. (SEGREGATE BETWEEN ADDITIONAL WORK AT CONTRACT PRICE, AGREED PRICE AND FORCE ACCOUNT.) UNLESS OTHERWISE STATED, RATES FOR RENTAL OF EQUIPMENT COVER ONLY SUCH TIME AS EQUIPMENT IS ACTUALLY USED AND NO ALLOWANCE WILL BE MADE FOR IDLE TIME. THE LAST PERCENTAGE SHOWN IS THE NET ACCUMULATED INCREASE OR DECREASE FROM THE ORIGINAL QUANTITY IN THE ENGINEER'S ESTIMATE.

Adjust soldier pile wall construction in accordance with revised Plan Sheets 38 thru 41, dated 9/30/2021 (CCO Pages 2-5), and Wall Drain Detail (CCO Page 6).

**INCREASE IN CONTRACT BID ITEMS AT CONTRACT BID ITEM PRICES**

ITEM NO. 22	LEAN CONCRETE BACKFILL				
	9.12 CY	32.57%	@	\$ 220.00 / CY	\$ 2,006.40
<b>TOTAL INCREASE =</b>					<b>\$ 2,006.40</b>

**DECREASE IN CONTRACT BID ITEMS AT CONTRACT BID ITEM PRICES**

ITEM NO. 19	STRUCTURE EXCAVATION (SOLDIER PILE WALL)				
	-40.50 CY	-25.00%	@	\$ 140.00 / CY	\$ (5,670.00)
ITEM NO. 20	STRUCTURE BACKFILL (SOLDIER PILE WALL)				
	-9.25 CY	-25.00%	@	\$ 500.00 / CY	\$ (4,625.00)
ITEM NO. 21	CONCRETE BACKFILL (SOLDIER PILE WALL)				
	-5.53 CY	-13.83%	@	\$ 290.00 / CY	\$ (1,603.70)
ITEM NO. 34	TIMBER LAGGING				
	-3.50 MFBM	-25.00%	@	\$ 6,970.00 / MFBM	\$ (24,395.00)
<b>TOTAL DECREASE =</b>					<b>\$ (36,293.70)</b>

The quantity increase shown for Item No. 22, Lean Concrete Backfill, and quantity decreases shown for Item No. 19, Structure Excavation (Soldier Pile Wall); Item No. 20, Structure Backfill (Soldier Pile Wall); Item No. 21, Concrete Backfill (Soldier Pile Wall); and Item No. 34, Timber Lagging, when combined with the quantities shown in the bid item list, and as modified by any previous change orders or revisions to dimensions made by the engineer, shall be the final quantities for which payment will be made.

A determination of the delay in completion of the project due to the work specified in this change order has been made in accordance with Section 8-1.02, Schedule, and Section 8-1.07, Delays, of the *Standard Specifications*. A time adjustment of thirty-eight (38) days is granted.

**ESTIMATED TOTAL DECREASE = \$ (34,287.30)**

BY REASON OF THIS CHANGE, THE CONTRACT TIME WILL BE INCREASED BY 38 WORKING DAYS

SUBMITTED BY:

SIGNATURE 	PRINT NAME AND TITLE ANGI SORENSEN, CONSTRUCTION ENGINEER	DATE 9/29/23
--	--	-----------------

DIRECTOR APPROVAL BY:

SIGNATURE 	PRINT NAME AND TITLE TOM MATTSO, DIRECTOR OF PUBLIC WORKS	DATE 9/29/23
--	--	-----------------

WE, THE UNDERSIGNED CONTRACTOR, HAVE GIVEN CAREFUL CONSIDERATION TO THIS CHANGE PROPOSED AND AGREE, IF THIS PROPOSAL IS APPROVED, THAT WE WILL PROVIDE ALL EQUIPMENT, FURNISH ALL MATERIALS, EXCEPT AS MAY OTHERWISE BE NOTED ABOVE, AND PERFORM ALL SERVICES NECESSARY FOR THE WORK ABOVE SPECIFIED, AND WILL ACCEPT AS FULL PAYMENT, THEREFORE, THE PRICES SHOWN ABOVE. NOTE: IF YOU, THE CONTRACTOR, DO NOT SIGN ACCEPTANCE OF THIS ORDER, YOUR ATTENTION IS DIRECTED TO THE REQUIREMENTS OF THE SPECIFICATION AS TO PROCEEDING WITH THE ORDERED WORK AND FILING A WRITTEN PROTEST WITHIN THE TIME THEREIN SPECIFIED.

CONTRACTOR ACCEPTANCE BY:

SIGNATURE 	PRINT NAME AND TITLE Matt Storm - Construction Manager	DATE 9/28/23
--	---	-----------------

Digitally signed by Matt Storm  
Contact Info:  
Construction Manager -  
North Coast Area  
Date: 2023.09.28  
18:54:26-07'00'



# CCO 04 Page 2

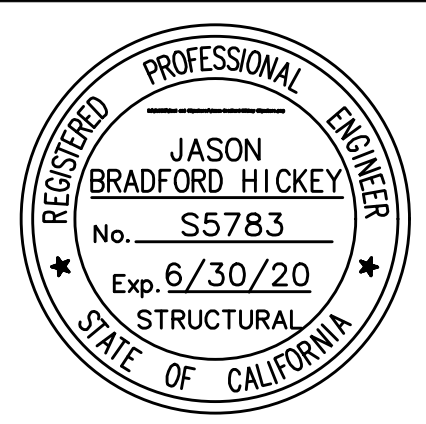

ROAD NAME: ALDERPOINT ROAD	MILE POST: 21.8, 22.8, 23.0-23.05	DESIGNED BY: YR
ROAD NO: F6B165	EA NO:	DRAWN BY: JD
PROJECT NO:	BRIDGE NO: N/A	REVIEWED BY: JH
CONTRACT NO:	DRAWING FILE NAME: 10_AP21.8_GP.dwg	APPROVED BY: GH
PLOT DATE: 9/30/2021	REVISION DATE:	

<b>COUNTY OF HUMBOLDT</b> <b>DEPARTMENT OF PUBLIC WORKS</b>	<b>SHEET 38</b> <b>OF 45</b>
<b>ALDERPOINT RD STORM DAMAGE (PM 21.8-23.05)</b>	
<b>GENERAL PLAN</b>	

MARK	DATE	DESCRIPTIONS	BY	CH'D
1	9-30-2021	RETAINING WALL LOCATION MODIFIED	JD	JH
REVISIONS				

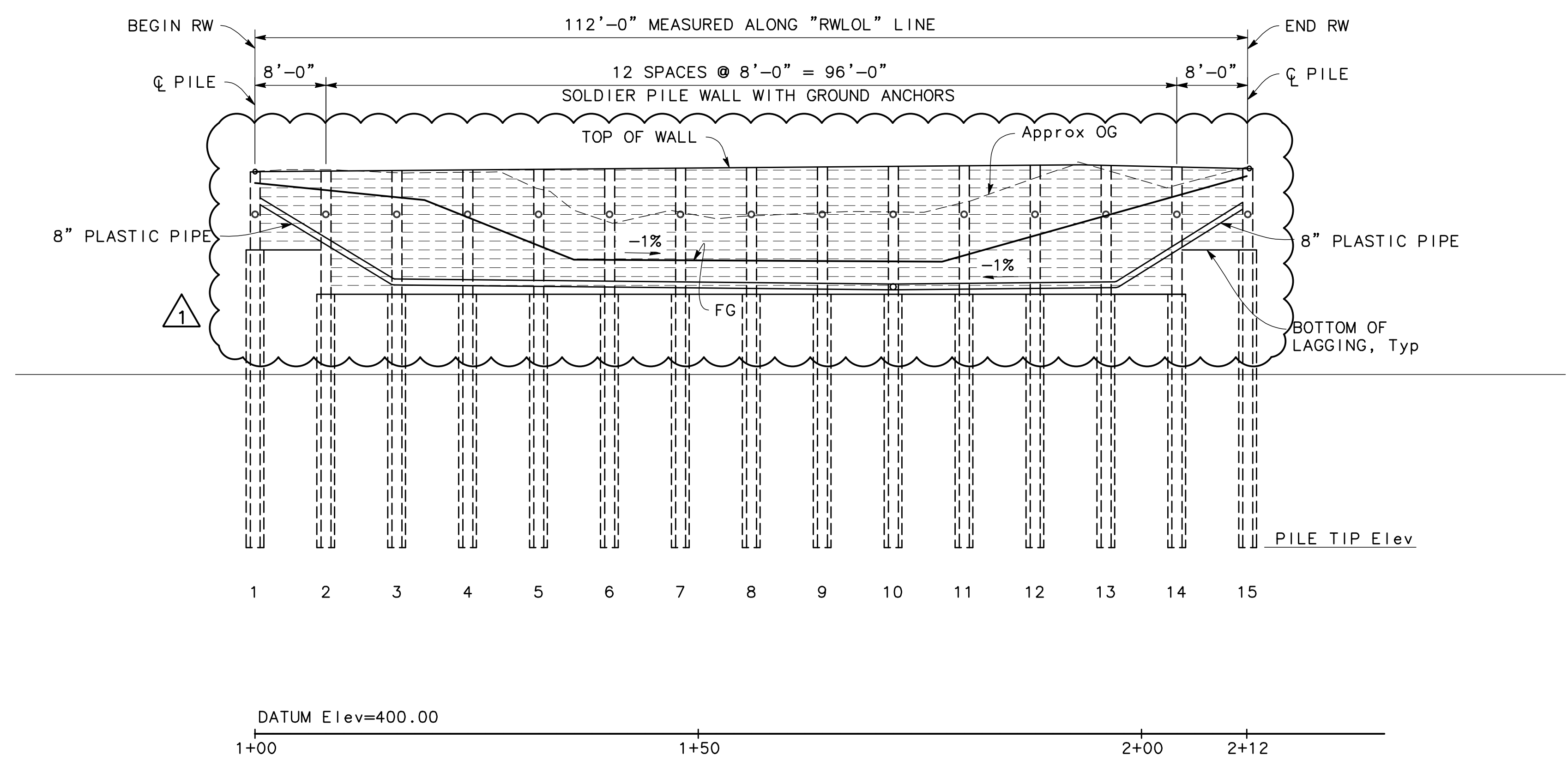

**MIRRORED DEVELOPED ELEVATION**  
1"=10'

CURVE	RADIUS	DELTA	TANGENT	LENGTH
C1	560.00'	9°38'29"	47.23'	94.23'
C2	543.50'	3°38'05"	17.24'	34.48'

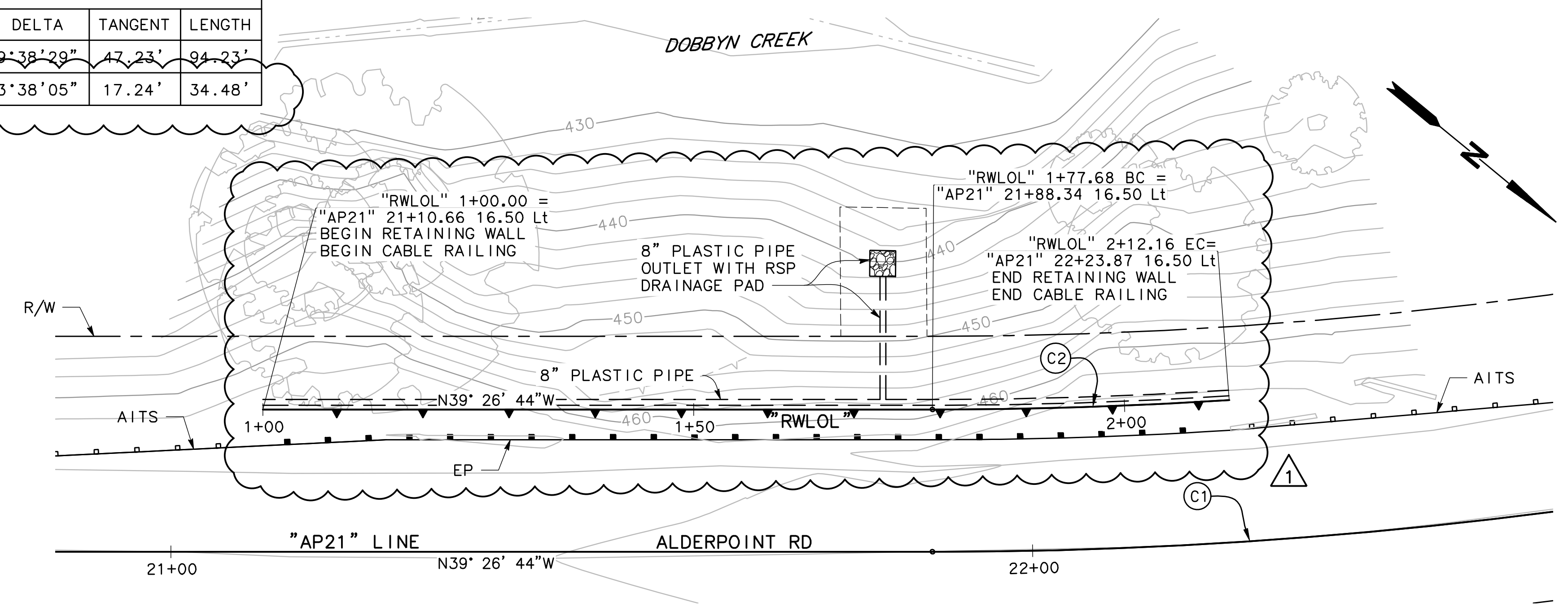

**PLAN**  
1"=10'

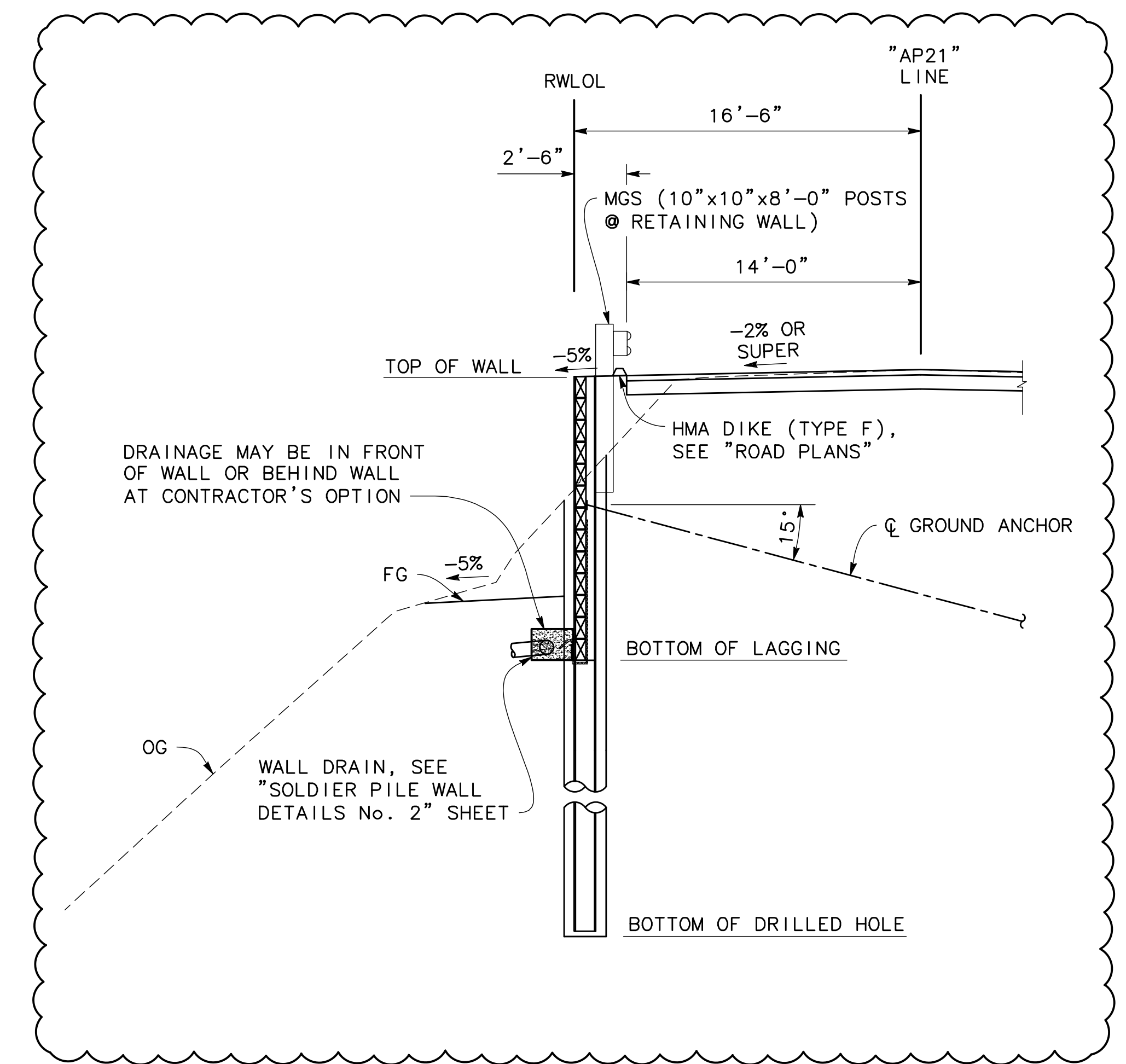

**TYPICAL SECTION**  
1"=5'

# CCO 04 Page 3

## INDEX TO PLANS

SHEET NO.	TITLE
38	GENERAL PLAN
39	INDEX TO PLANS
40	FOUNDATION PLAN
41	TYPICAL SECTION
42	SOLDIER PILE WALL LAGGING DETAILS
43	SOLDIER PILE WALL DETAILS NO. 1
44	SOLDIER PILE WALL DETAILS NO. 2
45	SUB HORIZONTAL GROUND ANCHOR DETAILS

## STANDARD PLANS DATED 2018

A3A	ABBREVIATIONS (SHEET 1 OF 3)
A3B	ABBREVIATIONS (SHEET 2 OF 3)
A3C	ABBREVIATIONS (SHEET 3 OF 3)
A10A	LEGEND - LINES AND SYMBOLS (SHEET 1 OF 5)
A10B	LEGEND - LINES AND SYMBOLS (SHEET 2 OF 5)
A10C	LEGEND - LINES AND SYMBOLS (SHEET 3 OF 5)
A10D	LEGEND - LINES AND SYMBOLS (SHEET 4 OF 5)
A10E	LEGEND - LINES AND SYMBOLS (SHEET 5 OF 5)
A10F	LEGEND - SOIL (SHEET 1 OF 2)
A10G	LEGEND - SOIL (SHEET 2 OF 2)
A10H	LEGEND - ROCK
A62C	LIMITS OF PAYMENT FOR EXCAVATION AND BACKFILL - BRIDGE SURCHARGE AND WALL
B11-47	CABLE RAILING

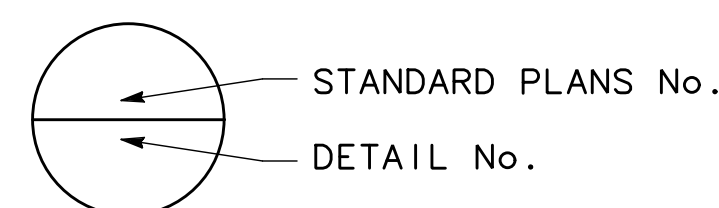

## QUANTITIES

STRUCTURE EXCAVATION (SOLDIER PILE WALL)	162 CY
STRUCTURE BACKFILL (SOLDIER PILE WALL)	37 CY
CONCRETE BACKFILL (SOLDIER PILE WALL)	40 CY
LEAN CONCRETE BACKFILL	28 CY
GROUND ANCHOR (SUBHORIZONTAL)	15 EA
STEEL SOLDIER PILE (W 12 X 65)	642 LF
24" DRILLED HOLE	578 LF
TIMBER LAGGING	14 MFBM
CLEAN AND PAINT STEEL SOLDIER PILING	1 LS
8" PERFORATED PLASTIC PIPE UNDERDRAIN	112 LF
CLASS 1 PERMEABLE MATERIAL	94 CY
CABLE RAILING	112 LF

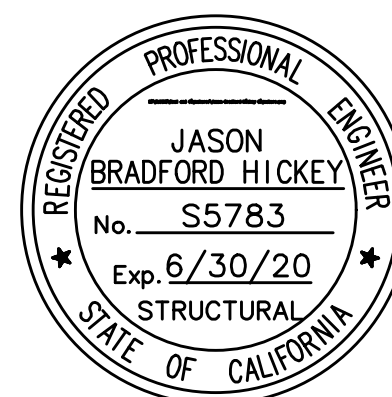

ROAD NAME: ALDERPOINT ROAD	MILE POST: 21.8, 22.8, 23.0-23.05
ROAD NO: F68165	EA NO:
PROJECT NO.:	BRIDGE NO: N/A
CONTRACT NO.:	DRAWING FILE NAME: 11 AP21.8_IP.dwg
PLOT DATE: 10/1/2021	REVISION DATE:

DESIGNED BY: MM	DRAWN BY: GB
REVIEWED BY: JH	APPROVED BY: GH

COUNTY OF HUMBOLDT  
DEPARTMENT OF PUBLIC WORKS  
ALDERPOINT RD STORM DAMAGE (PM 21.8-23.05)

SHEET  
**39**  
OF  
**45**

## INDEX TO PLAN

MARK	DATE	DESCRIPTIONS	BY	CH'D
1	9-30-2021	RETAINING WALL LOCATION MODIFIED	JD	JH
REVISIONS				

## GENERAL NOTES

DESIGN: AASHTO LRFD Bridge Design Specifications, 6th Edition with California Amendments.

LIVE LOAD: 0.3 x (design surcharge pressure) or 0.3 x (minimum surcharge pressure of 240 psf)

SOIL PARAMETERS: (For determination of Design Lateral Earth Pressures)  
Backfill soil weight =  $125 \text{ lb/ft}^3$   
Friction Angle =  $34^\circ$   
Active Pressure coefficient,  $K_a = 0.33$

SEISMIC PARAMETERS: Active (seismic) pressure coefficient.  $k_e = 0.8H$

STEEL SOLDIER PILES: ASTM A572/A, ASTM 572M Grade 50 Min, or ASTM A992

STRUCTURAL TIMBER: Treated Douglas Fir, Structural Grade  
Timber to be full sawn.

PRESTRESSING STEEL (GROUND ANCHORS):

FDL = Factored Design Load on ground anchor (kips)  
FTL = Factored Test Load (kips)  
LL = Lock-Off Load (kips)

fpu = Minimum ultimate tensile strength of ground anchor steel

As (Min) = Minimum cross sectional area of steel in ground anchor. (sq. in)

Steel = ASTM designation: A416 (HS Strands)

$$As (\text{Min}) = \frac{1.0 \text{ FTL}}{0.75 \text{ fpu}}$$

Steel = ASTM designation: A722 (HS Bars)

$$As (\text{Min}) = \frac{1.0 \text{ FTL}}{0.80 \text{ fpu}}$$

FDL = 160 kips

FTL = 160 kips

LL = 88 kips

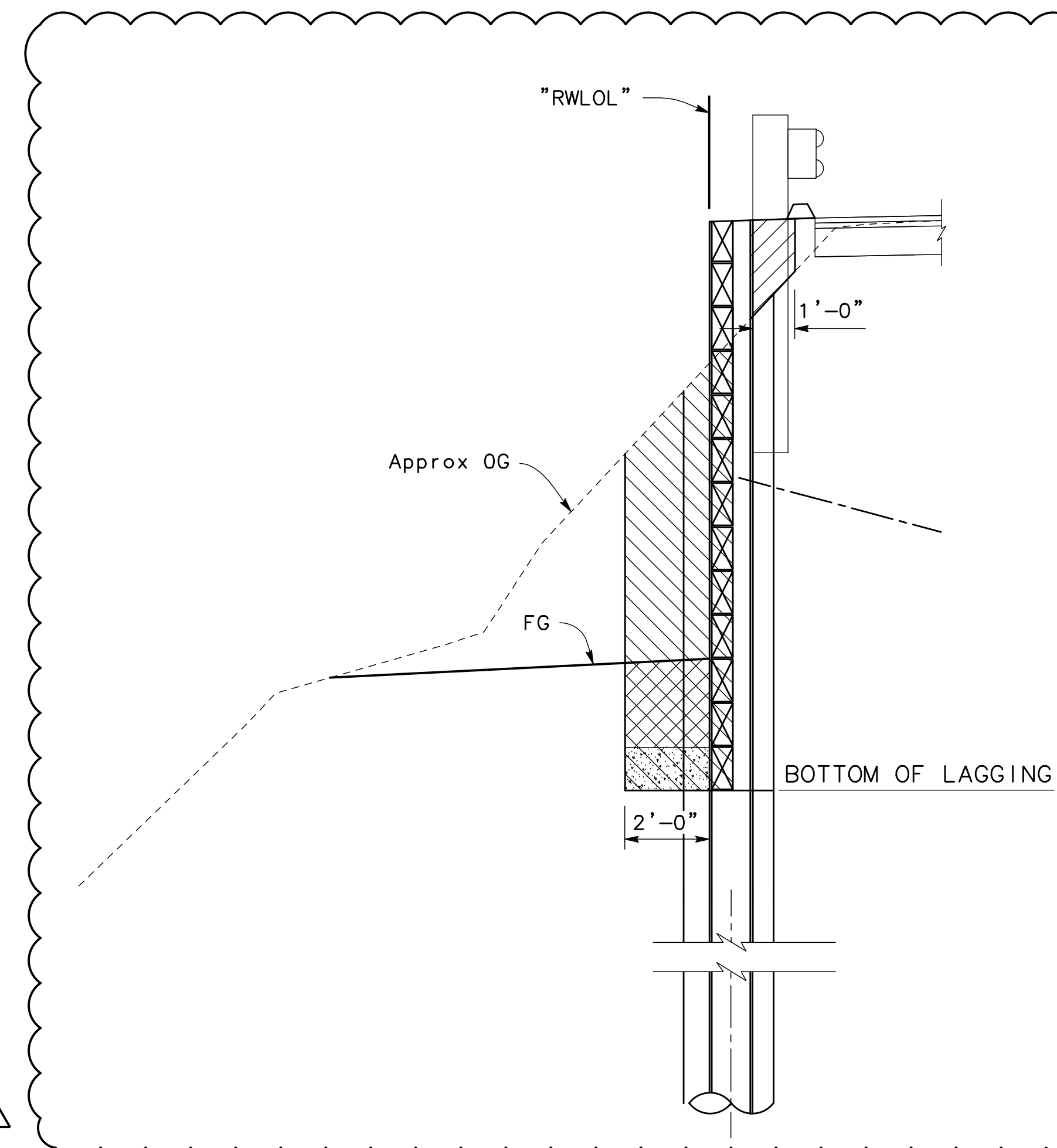

## STRUCTURE BACKFILL AND EXCAVATION

NO SCALE

- Indicates Structure Excavation, Soldier Pile Wall
- Indicates Structure Backfill, Soldier Pile Wall
- Indicates Permeable Material Class 1

NOTE:  
For limits of payments for roadway excavation, see "ROADWAY PLANS"



# CCO 04 Page 4

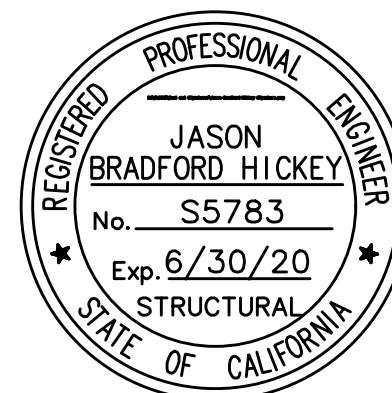

ROAD NAME: ALDERPOINT ROAD	MILE POST: 21.8, 22.8, 23.0-23.05
ROAD NO: F6B165	EA NO:
PROJECT NO:	BRIDGE NO: N/A
CONTRACT NO:	DRAWING FILE NAME: 12_AP21.8_FP.dwg
PLOT DATE: 9/30/2021	REVISION DATE:

<b>MARK THOMAS</b>
DESIGNED BY: YR
DRAWN BY: JD
REVIEWED BY: JH
APPROVED BY: GH

<b>COUNTY OF HUMBOLDT DEPARTMENT OF PUBLIC WORKS</b>
<b>ALDERPOINT RD STORM DAMAGE (PM 21.8-23.05)</b>
FOUNDATION PLAN

SHEET 40 OF 45

MARK	DATE	DESCRIPTIONS	BY	CH'D
1	9-30-2021	RETAINING WALL LOCATION MODIFIED	JD	JH
REVISIONS				

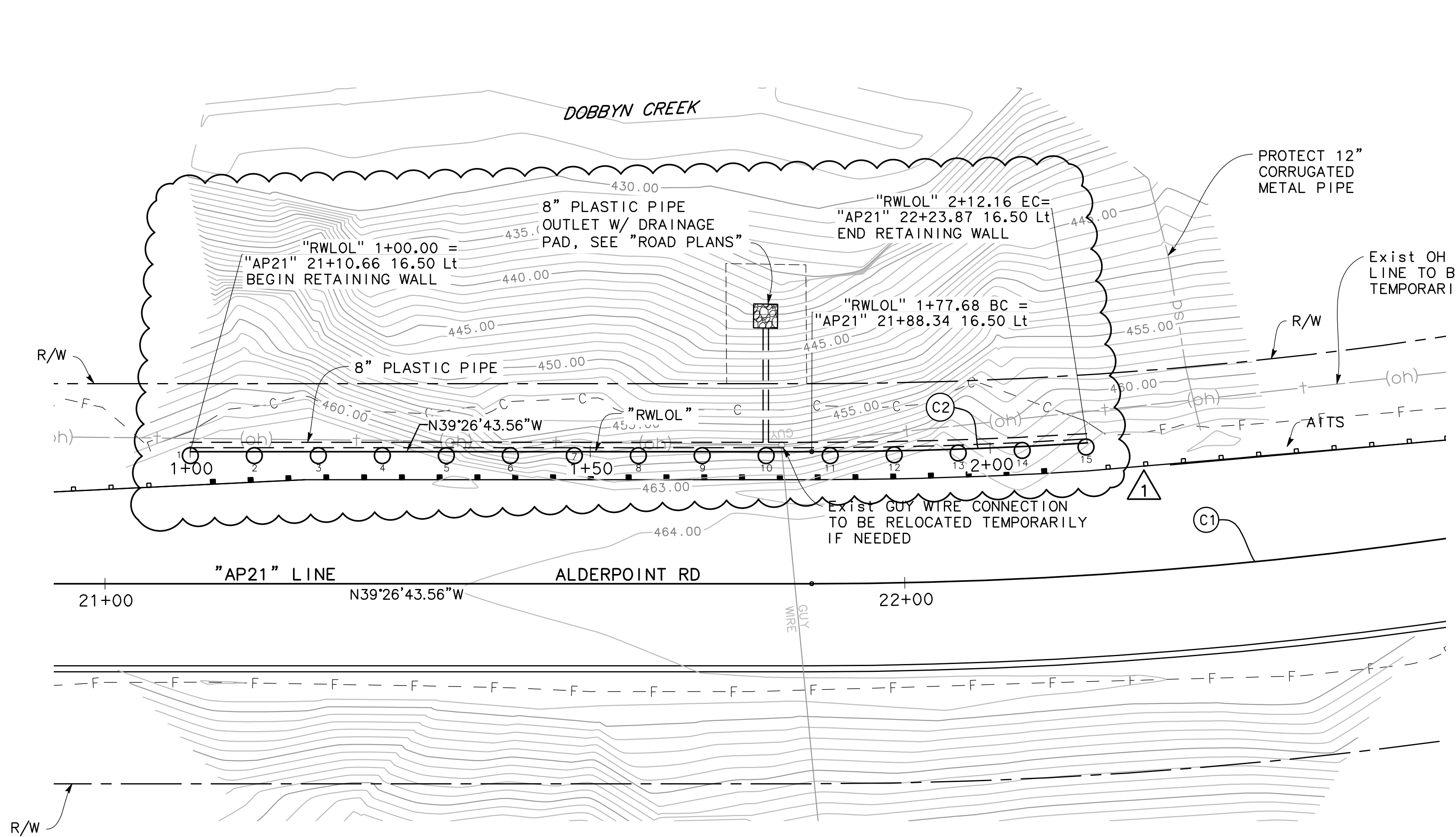

CURVE	RADIUS	DELTA	TANGENT	LENGTH
C1	560.00'	9°38'29"	47.23'	94.23'
C2	543.50'	3°38'05"	17.24'	34.48'

**PLAN**  
1"=10'

### LEGEND

- Indicates 24 inch diameter drilled hole
- - - F - - - Indicates Slope Fill Line, see "ROAD PLANS"
- - - C - - - Indicates Slope Cut Line, see "ROAD PLANS"

### BENCHMARK

Coordinates for this survey are California Coordinate System of 1983 (CCS83) Zone 1, NAD 83 (2011), Epoch 2010.0 based on a static GPS Control Survey using the NGS OPUS Post Processing Software. The control point identified as Point 51 was held for horizontal positions shown hereon. The mapping angle is 1 degree 10 minutes 9"; rotate bearings hereon counterclockwise by this angle to obtain "True" or Geodetic Bearings. Grid distances shown should be divided by the Combined Scale factor of 0.99985760 to obtain ground distances. Mapping angle and grid scale factor are taken at control point number 51, a 12 inch spike. Elevations are NAVD 88 datum based on OPUS solution utilizing the GEOID 12B model: an elevation of 1240.84 feet was measured at the aforementioned Control Point 51.

- NOTES:
- For Storm Drain Pipe details, see "ROADWAY PLANS"

# CCO 04 Page 5

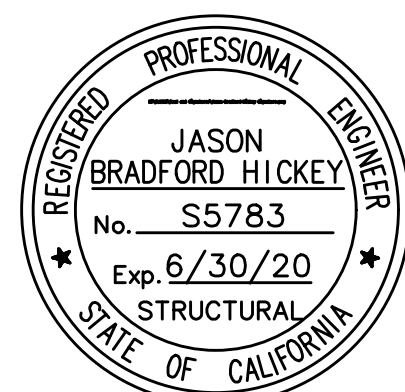

ROAD NAME: ALDERPOINT ROAD		MARK THOMAS		COUNTY OF HUMBOLDT DEPARTMENT OF PUBLIC WORKS		SHEET
ROAD NO: F68165	MILE POST: 21.8, 22.8, 23.0-23.05	DESIGNED BY: MM		ALDERPOINT RD STORM DAMAGE (PM 21.8-23.05)		41
PROJECT NO.:	EA NO.:	DRAWN BY: GB		REVISIONS		OF
CONTRACT NO.:	BRIDGE NO: N/A	REVIEWED BY: JH		TYPICAL SECTION		45
DRAWING FILE NAME: 13 AP21.8_TS.dwg	REVISION DATE:	APPROVED BY: GH				
PLOT DATE: 10/1/2021						

MARK	DATE	DESCRIPTIONS	BY	CH'D
1	9-30-2021	RETAINING WALL LOCATION MODIFIED	JD	JH

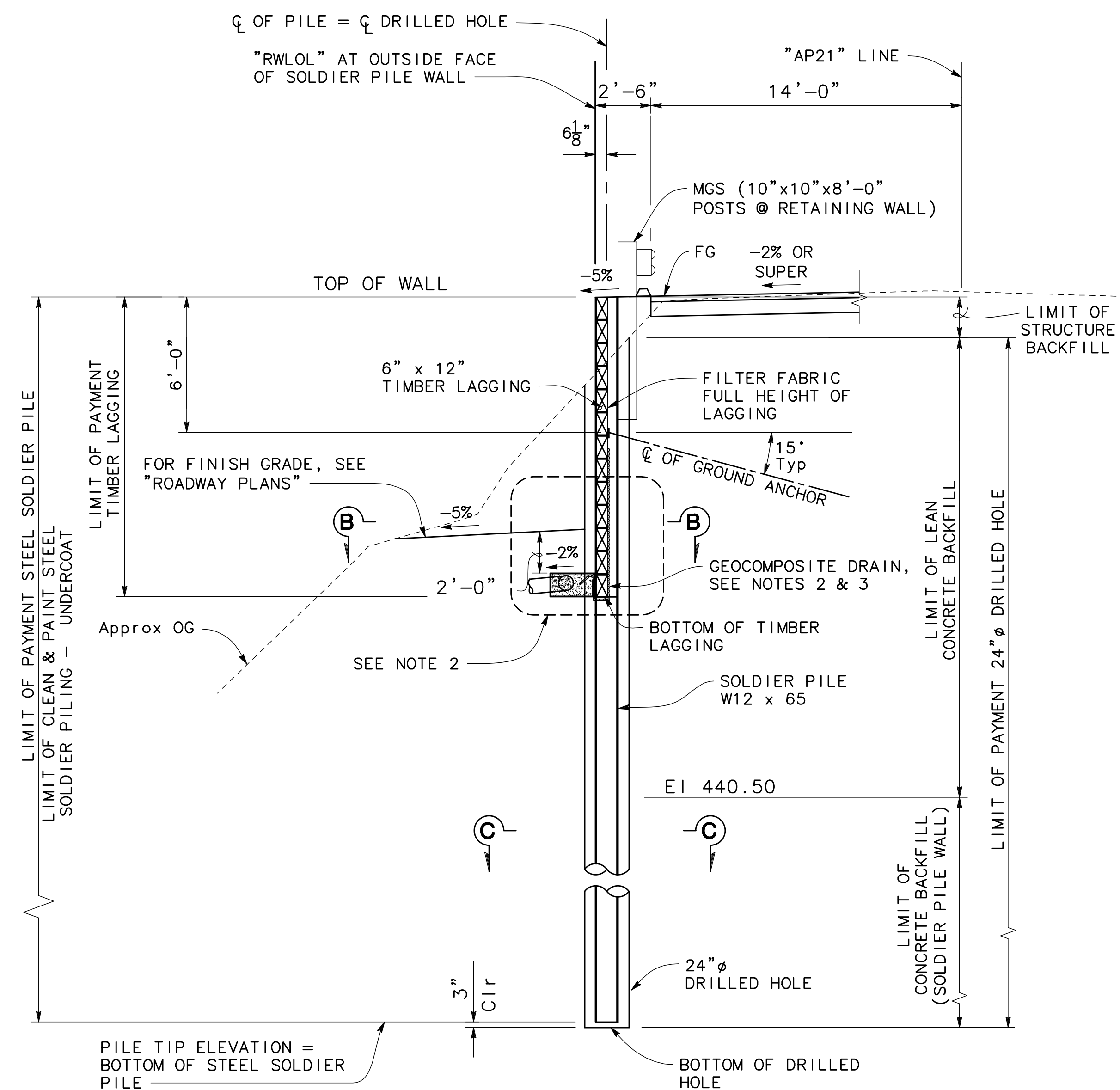

## TYPICAL SECTION - GROUND ANCHOR WALL

1/4" = 1'-0"

NOTES:

- For "SECTION B-B" and "SECTION C-C", see "SOLDIER PILE WALL LAGGING DETAILS" sheet.
- For "WALL DRAIN DETAIL", see "SOLDIER PILE WALL DETAILS No. 2" sheet.
- Continue geocomposite drain under timber lagging into permeable material.
- Clean and paint steel soldier pile from top of pile to 5 feet Min below bottom of lagging.

PILE NUMBER	"RWLOL" LINE STATION	TOP OF WALL ELEVATION	BOTTOM OF LAGGING ELEVATION	PILE TIP ELEVATION	GROUND ANCHORS
		(ft)	(ft)		UNBONDED LENGTH (ft)
1	1+00.00	463.37	454.54	421.0	27
2	1+08.00	463.43	449.54	421.0	27
3	1+16.00	463.50	449.54	421.0	27
4	1+24.00	463.57	449.54	421.0	27
5	1+32.00	463.63	449.54	421.0	27
6	1+40.00	463.70	449.54	421.0	27
7	1+48.00	463.77	449.54	421.0	27
8	1+56.00	463.83	449.54	421.0	27
9	1+64.00	463.90	449.54	421.0	27
10	1+72.00	463.97	449.54	421.0	27
11	1+80.00	464.03	449.54	421.0	27
12	1+88.00	464.10	449.54	421.0	27
13	1+96.00	464.08	449.54	421.0	27
14	2+04.00	463.90	454.54	421.0	27
15	2+12.00	463.73	-	421.0	27

NOTE:

Bottom of lagging indicates adjacent down station lagging elevation.



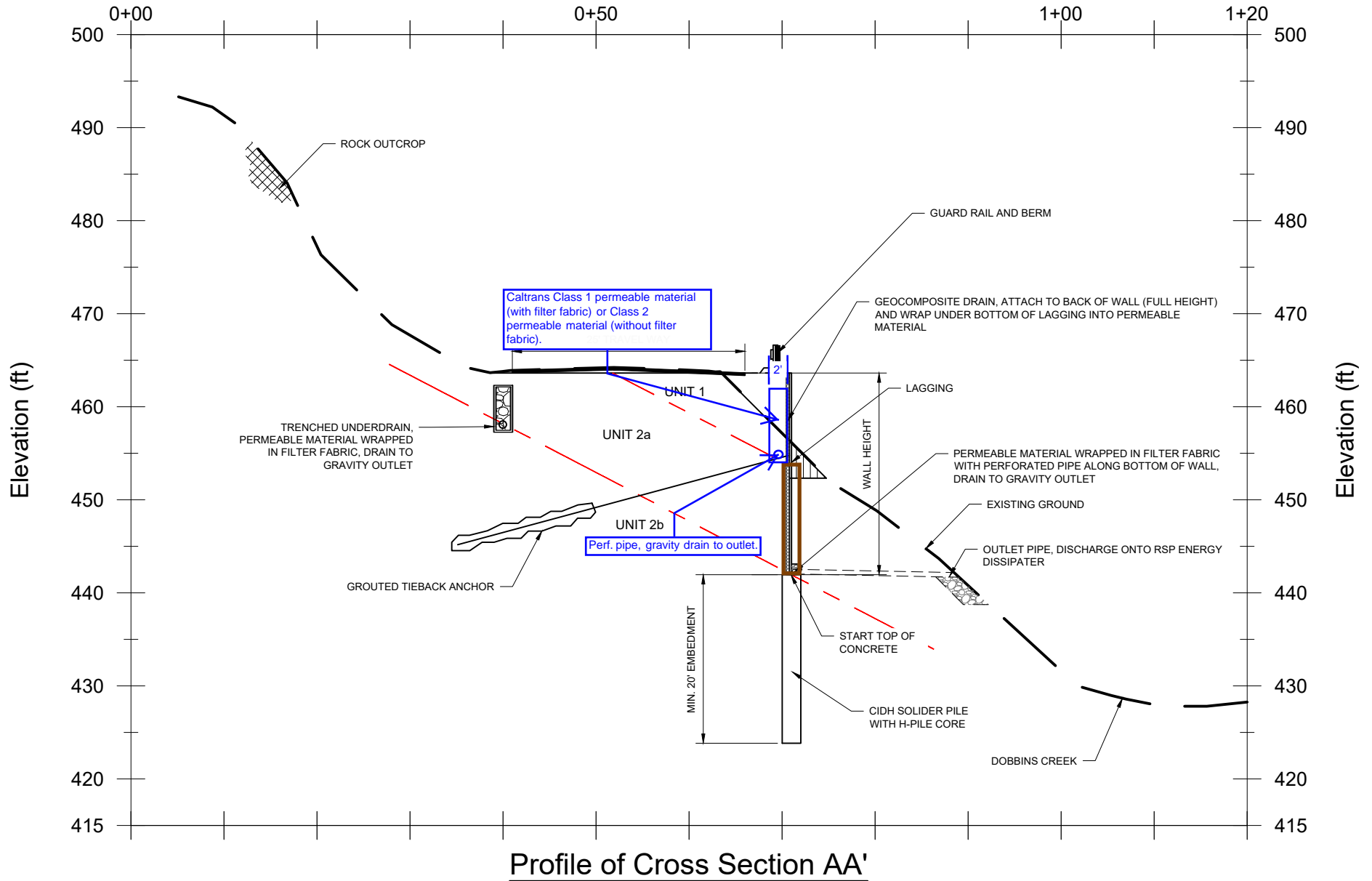



**CONTRACT CHANGE ORDER**Change Requested by: Engineer  Contractor 

CCO No.	Suppl. No.	Contract No.	Road	Federal Number(s)
5	0	217288 (PM 21.8-23.05)	Alderpoint Road (F6B165)	ER-32L0(329)

To: **Granite Construction Company,** Contractor

You are directed to make the following changes from the plans and specifications or do the following described work not included in the plans and specifications for this contract. **NOTE: This change order is not effective until approved by the Engineer.**

Description of work to be done, estimate of quantities and prices to be paid. (Segregate between additional work at contract price, agreed price and force account.) Unless otherwise stated, rates for rental of equipment cover only such time as equipment is actually used and no allowance will be made for idle time. The last percentage shown is the net accumulated increase or decrease from the original quantity in the Engineer's Estimate

**Payment Adjustment at Agreed Unit Price:**

In accordance with Section 9-1.07, "Payment Adjustments for Price Index Fluctuations," of the *Standard Specifications*, compensation payable for the following bid item(s) will be subject to increased or decreased payment adjustments for fluctuations in the California Paving Asphalt Price Index for the month the material is placed exceeds more than 5 percent relative to the crude oil price index at the time of bid.

Bid Item 28, "Hot Mix Asphalt (Type A)"

For an increase in crude oil price index exceeding 5 percent:  $A = [(lu/lb) - 1.05] \times lb \times [1 + (T/100)]$ For a decrease in crude oil price index exceeding 5 percent:  $A = [(lu/lb) - 0.95] \times lb \times [1 + (T/100)]$ 

Where T stands for Sales Tax (7.75%).

BID ITEM	MONTH	%OIL	TONS	Q	lu	lb	lu/lb	A	ADJUSTMENT
28	Oct 21	5.9	576.00	33.98	405.7	354.4	1.14	36.18	\$1,229.40
28	Nov 21	5.9	74.76	4.38	456.2	354.4	1.29	90.60	\$396.83
28	Dec 21	5.9	193.25	33.98	433.6	354.4	1.22	66.19	\$754.57
28	Aug 22	5.9	<u>117.57</u>	6.94	582.6	354.4	1.64	226.79	<u>\$1,573.92</u>
			960.98					Total	\$3,954.72

For this work, the contractor agrees to accept payment in the amount of \$3,954.72. This sum constitutes full and complete compensation for providing all labor, materials, equipment, tools and incidentals, including all markups for this change.

Payment adjustment at agreed unit price: \$3,954.72.

This change order does not affect the controlling activity. No time adjustment is warranted.

Estimated Cost: Decrease  Increase  \$ 3,954.72**By reason of this order the time of completion will be adjusted as follows: None**

Submitted by

Signature	(Print name & title)	Date
	Chase Richardson., Resident Engineer	9/22/2023

Approval Recommended by

Signature	(Print name & title)	Date
	Angi Sorensen, P.E., Assoc. Civil Engineer	9/29/23

Engineer Approval by

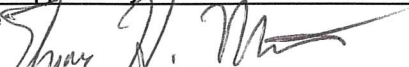
Signature	(Print name & title)	Date
	Thomas K. Mattson, P.E., Director of Public Works	9/28/23

We the undersigned contractor, have given careful consideration to the change proposed and agree, if this proposal is approved, that we will provide all equipment, furnish the materials, except as may otherwise be noted above, and perform all services necessary for the work above specified, and will accept as full payment therefor the prices shown above. **NOTE: If you, the contractor, do not sign acceptance of this order, your attention is directed to the requirements of the specification as to proceeding with the ordered work and filing a written protest within the time therein specified.**

Contractor Acceptance by

Signature	(Print name & title)	Date
 Digitally signed by Matt Storm Contact Info: Construction Manager - North Coast Area Date: 2023.09.28 18:52:59-07'00'	Matt Storm - Construction Manager	9/28/23



**CONTRACT CHANGE ORDER**Change Requested by: Engineer  Contractor 

CCO No.	Suppl. No.	Contract No.	Road	Federal Number(s)
1	0	217294 (PM 23.75)	Alderpoint Road (F6B165)	ER-32L0(300)

To: Granite Construction Company, Contractor

You are directed to make the following changes from the plans and specifications or do the following described work not included in the plans and specifications for this contract. **NOTE: This change order is not effective until approved by the Engineer.**

Description of work to be done, estimate of quantities and prices to be paid. (Segregate between additional work at contract price, agreed price and force account.) Unless otherwise stated, rates for rental of equipment cover only such time as equipment is actually used and no allowance will be made for idle time. The last percentage shown is the net accumulated increase or decrease from the original quantity in the Engineer's Estimate

Project Location PM 23.75: 1) Provide compensation for authorized extra work. 2) Provide a contract time extension.

**1) Extra Work at Agreed Lump Sum Price:**

In accordance with the provisions of Section 4-1.05, Changes and Extra Work, and Section 9-1.04, Force Account, of the Standard Specifications, provide compensation for the following work authorized by the Engineer:

- Place additional RSP at outlet of 48-inch CSP Culvert.
- Place filter fabric and soil to construct roadway shoulder over RSP at culvert outlet.
- Place aggregate base on roadway shoulders.

For this specified work, the Contractor agrees to accept a lump sum payment of **\$9,160.00**. This sum shall constitute full compensation for the work, complete in-place, including all markups.

**2) Time Adjustment:**

Based on a time impact analysis (TIA), a determination of the delay in completion of the contract due to the work specified Contract Change Order No. 1 has been made in accordance with Sections 4-1.05, Changes and Extra Work, and 8-1.07B, Time Adjustments, of the Standard Specifications. A two (2) working day extension is granted.

The work specified in Change Order No. 1 delayed the controlling operation and completion of the contract by a period of two (2) working days which include the following dates: August 20, 2021 and September 22, 2021.

Estimated Cost: Decrease  Increase  \$ 9,160.00

By reason of this order the time of completion will be adjusted as follows: **TWO (2) WORKING DAY EXTENSION**

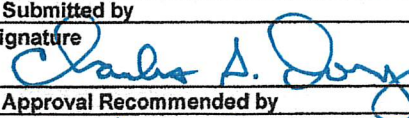
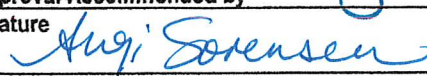
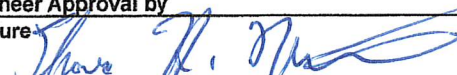
Submitted by		
Signature	(Print name & title)	Date
	Charles A. Dory, P.E., Resident Engineer	3/5/2022
Approval Recommended by		
Signature	(Print name & title)	Date
	Angi Sorensen, P.E., Assoc. Civil Engineer	4/20/22
Engineer Approval by		
Signature	(Print name & title)	Date
	Thomas K. Mattson, P.E., Director of Public Works	4/30/22

We the undersigned contractor, have given careful consideration to the change proposed and agree, if this proposal is approved, that we will provide all equipment, furnish the materials, except as may otherwise be noted above, and perform all services necessary for the work above specified, and will accept as full payment therefor the prices shown above. **NOTE: If you, the contractor, do not sign acceptance of this order, your attention is directed to the requirements of the specification as to proceeding with the ordered work and filing a written protest within the time therein specified.**

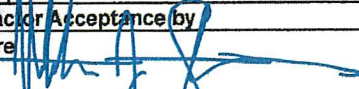
Contractor Acceptance by		
Signature	(Print name & title)	Date
	Matt Storm - Construction Manager	4/4/22