

AGREEMENT

This is an AGREEMENT made and entered into this 3rd day
of September, 2021, by and between the County of Humboldt, a
political subdivision of the State of California (hereinafter referred to as COUNTY)
and GR Wilcox Enterprises, Inc.,
a corporation organized and existing under the laws of the State of California,
hereinafter referred to as "CONTRACTOR".

Section 1 - SCOPE OF WORK

Contractor shall furnish all Labor, Tools and Materials and perform all the work for the:

**STORM DAMAGE REPAIR TO TELEGRAPH CREEK ROAD (4A150) PM 1.90 AND PUMA
DRIVE (4A125) PM 0.10, 0.21, 0.25, 0.60
PROJECT NO.: FEMA 4308-DR-CA PW-1433, PW-1309 AND 4434-DR-CA PW-0212
CONTRACT NO.: 217345, 219342, 219343, 217541, 219346**

in accordance with the contract documents referred to in Section 3 of this Agreement.

Section 2 - CONTRACT PRICE

County shall pay, and Contractor shall accept Contractor's Bid Prices, as shown on EXHIBIT "A" attached hereto and made a part hereof, as full compensation for furnishing all materials and for doing all the work contemplated and embraced in this Agreement; also for all loss or damage, arising out of the work aforesaid, or from the actions of the elements, or from any unforeseen difficulties or obstructions which may arise or be encountered in the prosecution of the work until its acceptance by County, and for all risks of every description connected with the work; also for all expenses incurred by or in consequence of the suspension or discontinuance of the work and for well and faithfully completing the work, and the whole thereof, in the manner and according to the Plans and Specifications, and the requirements of the Engineer.

Section 3 - CONTRACT DOCUMENTS

The complete contract between the parties hereto shall consist of the following, hereinafter referred to as the CONTRACT DOCUMENTS:

- Notice to Bidders
- Plans and Drawings
- Bid Form
- Bidder's Bond
- Supplemental Project Information
- Performance Bond
- Payment Bond
- This Agreement
- Special Provisions

And, as published by the Department of Transportation, State of California, except as modified by the Special Provisions:

- Standard Plans - dated 2018
- Revised Standard Plans – dated 04-17-2020
- Standard Specifications - dated 2018
- Revised Standard Specifications Dated 04-17-2020
- Equipment Rental Rates in effect at the time the work is performed

And, as published by the California Department of Industrial Relations, and the California Business, Transportation and Housing Agency:

- General Prevailing Wage Rates
- Labor and Surcharge Rates

And any addenda to any of the above documents, all of which are on file in the office of the Director of Public Works of the County of Humboldt. Each of said CONTRACT DOCUMENTS is incorporated and made a part of this Agreement by the reference contained in this Section.

All rights and obligations of the County and the Contractor are fully set forth and described in the Contract Documents. All of the above named documents are intended to be complimentary, so that any work called for in one, and mentioned in the other is to be performed and executed the same as if mentioned in all said documents.

Section 4 - BEGINNING OF WORK

Following receipt and full execution and approval of the Contract Documents, and posting of the requisite Bonds as called for therein, the COUNTY will issue a "Notice to Proceed". Under no circumstances shall the CONTRACTOR enter upon the site of work until receipt of the "Notice to Proceed", or unless so authorized in writing by the COUNTY.

Section 5 - TIME OF COMPLETION

The work called for in this Agreement shall be commenced within fifteen (15) days of receipt of Notice to Proceed by COUNTY and shall be fully completed within a period of 85 working days beginning on the fifteenth calendar day after the date of said approval of contract.

Section 6 - PREVAILING WAGE

Copies of the prevailing wage rates of per diem wages are on file in the Humboldt County Public Works office at 1106 Second Street, Eureka, California and are available to any interested person on request.

Section 7 - WORKERS' COMPENSATION

By my signature hereunder, as CONTRACTOR, I certify that I am aware of the provisions of Section 3700 of the Labor Code which requires every employer to be insured against liability for Workers' Compensation or to undertake self insurance in accordance with the provisions of that code, and I will comply with such provisions before commencing the performance of the work of this contract.

Section 8 - COMPLIANCE WITH LAWS

The Contractor agrees to comply with all local, state, and federal laws and regulations, including but not limited to the Americans With Disabilities Act. The Contractor further agrees to comply with any applicable federal, state or local licensing standards, any applicable accrediting standards, and any other applicable standards or criteria established locally or by the state or federal governments.

This agreement shall be governed by and construed in accordance with the laws of the State of California.

Section 9 - NOTICES

All notices shall be in writing and delivered in person or transmitted by mail. Notices required to be given to the COUNTY shall be addressed as follows:

Humboldt County Department of Public Works
1106 Second Street, Eureka, California, 95501

✓ Notices required to be given to CONTRACTOR shall be addressed as follows:

G. R. WILCOX ENT INC

Box 186

WHITETHORN CAL 95589

IN WITNESS WHEREOF, The parties hereto have entered into this Agreement as of the date first above set forth.

COUNTY OF HUMBOLDT

(SEAL)

BY Vuagnie Bass

Chair, Board of Supervisors
of the County of Humboldt,
State of California

ATTEST:

KATHY HAYES

Clerk of the Board of Supervisors
of the County of Humboldt,
State of California

BY [Signature]
Clerk of the Board

✓ GR WILCOX ENTERPRISES, INC.

BY [Signature]

TITLE SEC

BY [Signature]

TITLE President

(Two Signatures Required For Corporation)

APPROVED AS TO FORM:

BY N/A
Deputy County Counsel

INSURANCE CERTIFICATES REVIEWED
AND APPROVED:

BY [Signature]
Risk Manager

ADDENDUM NO.1
BID FORM (EXHIBIT A, PAGE 1 OF 2)
STORM DAMAGE REPAIR TO TELEGRAPH CREEK ROAD (4A150)
PM 1.90 AND PUMA DRIVE (4A125) PM 0.10, 0.21, 0.25, 0.60
PROJECT NO.: FEMA 4308-DR-CA PW-1433, PW-1309 AND 4434-DR-CA PW-0212
CONTRACT NO.: 217345, 219342, 219343, 217541, 219346

ITEM NO.	ITEM CODE	ITEM DESCRIPTION	UNIT	QTY	UNIT PRICE	TOTAL
1	038391	Fish Habitat Structure - Root Wad	EA	2	3080.00	6160.00
2	120090	Construction Area Signs	EA	14	225.00	3150.00
3	120100	Traffic Control System	LS	1	7238.00	7238.00
4	128651	Portable Changeable Message Sign	EA	1	5163.00	5163.00
5	130100	Job Site Management	LS	1	25,476.00	25,476.00
6	130200	Prepare Water Pollution Control Program	LS	1	2072.00	2072.00
7	130900	Temporary Concrete Washout	EA	1	880.00	880.00
8	131201	Temporary Creek Diversion System	LS	1	23,600.00	23,600.00
9	150200	Remove Temporary Railroad Flatcar Bridge	LS	1	6940.00	6940.00
10	170103	Clearing and Grubbing (LS)	LS	1	18,880.00	18,880.00
11	190101	Roadway Excavation	CY	527	34.80	18,339.60
12	192025	F Structure Excavation (Culvert & Channel)	CY	3,080	11.20	34,496.00
13	192037	F Structure Excavation (Retaining Wall)	CY	643	27.17	17,470.31
14	193004	F Structure Backfill (Culvert)	CY	510	50.20	25,602.00
15	193013	F Structure Backfill (WWW Retaining Wall)	CY	460	56.00	25,760.00
16	198050	F Embankment	CY	1,692	31.80	53,805.60
17	210212	Dry Seed (SQFT)	SQFT	10,111	.66	6673.26
18	210280	Rolled Erosion Control Product (Blanket)	SQYD	865	11.76	10,172.40
19	210350	Fiber Rolls	LF	460	11.50	5290.00
20	210420	Straw	SQFT	6,464	.56	3619.84
21	210500	Willow Stakes	EA	200	67.20	13,440.00
22	210501	Alder Tree	EA	24	112.00	2688.00
23	260203	F Class 2 Aggregate Base (CY)	CY	441	98.14	43,288.56
24	390132	Hot Mix Asphalt (Type A)	TON	309	275.00	84,975.00
25	394073	Hot Mix Asphalt Dike Type A	LF	440	21.28	9363.20
26	477020	F Mechanically Stabilized Embankment (Wire Wall)	SQFT	944	43.13	40,714.72
27	510091	F Structural Concrete (Arch Culvert-Footings)	CY	104	605.00	62,920.00
28	510092	F Structural Concrete (Headwall & Wingwalls)	CY	114	696.49	79,399.86
29	510502	Minor Concrete, Minor Structure (Drainage Inlets, Junction)	EA	4	3197.00	12,788.00
30	520101	F Bar Reinforcing Steel	LBS	17,560	4.40	77,264.00

ADDENDUM NO. 1
BID FORM (EXHIBIT A, PAGE 2 OF 2)

31	641107	18" Plastic Pipe (Heat-Fused HDPE)	LF	434	124.17	53,889.78
32	674960	P 22'x8'-11" Structural Plate, Arch Culvert (0.170 in, 8 Ga.)	LF	70	1597.00	111,790.00
33	680902	6" Perforated Plastic Pipe Underdrain	LF	108	12.60	1360.80
34	680903	6" Non-Perforated Plastic Pipe Underdrain	LF	31	12.60	390.60
35	681132	Geocomposite Drain	SQFT	912	6.56	5982.72
36	682023	Class 1 Permeable Material (Type B)	CY	95	254.15	24,144.25
37	692381	Concrete Anchor and Cable Assembly	EA	4	3350.00	13,400.00
38	710132	Remove Culvert	LF	405	28.25	11,441.25
39	710155	Remove Concrete Headwalls, Wingwalls and Apron at Outlet	LS	1	11,200.00	11,200.00
40	720000	F Engineered Streambed Material	CY	180	266.80	48,024.00
41	723017	F Rock Slope Protection (Class VIII & IX, Method A) (Weirs)	CY	150	287.30	43,095.00
42	723035	F Rock Slope Protection-Roughened Channel (Class VII & IX)	CY	45	551.10	24,799.50
43	723050	Rock Slope Protection (1/4 T, Class V, Method B) (CY)	CY	152	176.84	26,879.68
44	750500	Miscellaneous Metal (Inlet Grate, 24-12X Galvanized)	LBS	956	4.24	4053.44
45	770200	Repair Water Line	LS	1	24,030.00	24,030.00
46	832006	Midwest Guardrail System (Steel Post)	LF	75	220.00	16,500.00
47	839581	End Anchor Assembly (Type SFT)	EA	1	2200.00	2200.00
48	839585	Alternative Flared Terminal System	EA	1	6600.00	6600.00
49	840656	Paint Traffic Stripe (2 coat)	LF	860	13.12	11,283.20
50	999990	Mobilization	LS	1	8000.00	8000.00

NOTE: ITEM CODE LETTER DESIGNATION; P=PARTIAL PAY, F=FINAL PAY QUANTITY

BID TOTAL 1,176,693.40

1,176,693.57 *mm*

ACKNOWLEDGEMENT OF ADDENDAADDENDUM NO.INITIAL

1
2

C.W
C.W



 (Bidder's Signature)

SEC

 (Title)



County of Humboldt
Department of Public Works
1106 Second Street
Eureka, CA 95501
TEL (707) 445-7652

ADDENDUM NO. 1
 (Issued June 23, 2021)

**STORM DAMAGE REPAIR TO TELEGRAPH CREEK ROAD (4A150)
 PM 1.90 AND PUMA DRIVE (4A125) PM 0.10, 0.21, 0.25, 0.60**
PROJECT NO.: FEMA 4308-DR-CA PW-1433, PW-1309 AND 4434-DR-CA
PW-0212 CONTRACT NO.: 217345, 219342, 219343, 217541, 219346

The Special Provisions and Plans are hereby modified in accordance with the following:

1. The bid opening location is changed to the Humboldt County Public Works building on 1106 2nd Street, Eureka CA. Bids will be opened outside the building in the adjacent parking lot. The bid opening date and time have not changed.

Options for delivering bid packages:

- Mail or use delivery service (FedEx or UPS) to send bid package to Public Works, 1106 2nd Street, Eureka, CA.
- Deposit bid package into mail slot in the front door of Public Works, 1106 2nd Street, Eureka, CA.
- Hand deliver to Engineering Staff between 1:45pm and 2:00pm at the opening site.
- Bid packages must be received before 2:00pm.

Project Special Provisions

1. Special Provisions, pages 74-75, Bid Form (Exhibit A) shall be replaced by the attached Addendum No. 1 Bid Form (Exhibit A)
2. Special Provisions, Notice to Bidders page 1, the Engineer's Estimate is revised to be \$1,156,000.

IMPORTANT

This Addendum is being sent EMAIL/FAX. To indicate receipt of this Addendum please sign and send back to the Department of Public Works.

EMAIL: PWEngineering@co.humboldt.ca.us
or FAX: (707) 445-7409

Received by: GARY WILCOX Date 6-23-21

Company: G.R. WILCOX # Pages Received 11

Total Pages Sent 11

(Addendum No. 1)

Project Plans

1. Sheet 2, Project Quantities by Location table updated.
2. Sheet 7, headwall, wingwall, and footing design updated.
3. Sheet 9, headwall, wingwall, and footing design updated.
4. Sheet 11, headwall, wingwall, and footing design updated.
5. Sheet 14, headwall, wingwall, and footing design updated.
6. Sheet 15, headwall, wingwall, and footing design updated.

Contractor Questions

The information below is provided in response to written bidder inquiries. The following item shall become part of the contract documents for this project and all other conditions shall remain the same:

Question 1: If work at or below the ordinary high water level is not completed by October 31, 2021, per the project time frame and seasonal work period described in the RWQCB and CDFW permits, will the county allow the project to enter winter suspension?

Answer: *Yes. If the instream work at Telegraph Creek Road PM 1.90 is not completed by October 31, 2021 and the county is denied permit extensions into the winter, the county will allow the project to enter winter suspension and will suspend the working days.*

Question 2: It will be difficult to begin working days within 15 calendar days of contract execution per the special provisions due to the long lead times involved when supplying a large, structural plate arch culvert. Will the county postpone the beginning of work to 55 calendar days (similar to other projects with large amounts of steel)?

Answer: *The county will not postpone the beginning of working days and the contractor is expected to begin work within 15 calendar days after contract execution. The contractor may work on other project locations while waiting for the structural plate arch culvert for Telegraph Creek Road PM 1.90.*

Approved:

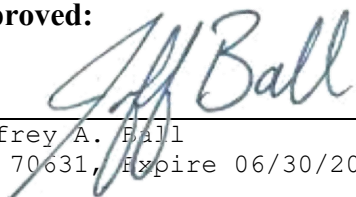

Jeffrey A. Ball
RCE 70631, Expire 06/30/2021

06/23/2021

Date

ADDENDUM NO.1
BID FORM (EXHIBIT A, PAGE 1 OF 2)
STORM DAMAGE REPAIR TO TELEGRAPH CREEK ROAD (4A150)
PM 1.90 AND PUMA DRIVE (4A125) PM 0.10, 0.21, 0.25, 0.60
PROJECT NO.: FEMA 4308-DR-CA PW-1433, PW-1309 AND 4434-DR-CA PW-0212
CONTRACT NO.: 217345, 219342, 219343, 217541, 219346

ITEM NO.	ITEM CODE	ITEM DESCRIPTION	UNIT	QTY	UNIT PRICE	TOTAL
1	038391	Fish Habitat Structure - Root Wad	EA	2		
2	120090	Construction Area Signs	EA	14		
3	120100	Traffic Control System	LS	1		
4	128651	Portable Changeable Message Sign	EA	1		
5	130100	Job Site Management	LS	1		
6	130200	Prepare Water Pollution Control Program	LS	1		
7	130900	Temporary Concrete Washout	EA	1		
8	131201	Temporary Creek Diversion System	LS	1		
9	150200	Remove Temporary Railroad Flatcar Bridge	LS	1		
10	170103	Clearing and Grubbing (LS)	LS	1		
11	190101	Roadway Excavation	CY	527		
12	192025	F Structure Excavation (Culvert & Channel)	CY	3,080		
13	192037	F Structure Excavation (Retaining Wall)	CY	643		
14	193004	F Structure Backfill (Culvert)	CY	510		
15	193013	F Structure Backfill (WWW Retaining Wall)	CY	460		
16	198050	F Embankment	CY	1,692		
17	210212	Dry Seed (SQFT)	SQFT	10,111		
18	210280	Rolled Erosion Control Product (Blanket)	SQYD	865		
19	210350	Fiber Rolls	LF	460		
20	210420	Straw	SQFT	6,464		
21	210500	Willow Stakes	EA	200		
22	210501	Alder Tree	EA	24		
23	260203	F Class 2 Aggregate Base (CY)	CY	441		
24	390132	Hot Mix Asphalt (Type A)	TON	309		
25	394073	Hot Mix Asphalt Dike Type A	LF	440		
26	477020	F Mechanically Stabilized Embankment (Wire Wall)	SQFT	944		
27	510091	F Structural Concrete (Arch Culvert-Footings)	CY	104		
28	510092	F Structural Concrete (Headwall & Wingwalls)	CY	114		
29	510502	Minor Concrete, Minor Structure (Drainage Inlets, Junction)	EA	4		
30	520101	F Bar Reinforcing Steel	LBS	17,560		

**ADDENDUM NO. 1
 BID FORM (EXHIBIT A, PAGE 2 OF 2)**

31	641107		18" Plastic Pipe (Heat-Fused HDPE)	LF	434		
32	674960	P	22'x8'-11" Structural Plate, Arch Culvert (0.170 in, 8 Ga.)	LF	70		
33	680902		6" Perforated Plastic Pipe Underdrain	LF	108		
34	680903		6" Non-Perforated Plastic Pipe Underdrain	LF	31		
35	681132		Geocomposite Drain	SQFT	912		
36	682023		Class 1 Permeable Material (Type B)	CY	95		
37	692381		Concrete Anchor and Cable Assembly	EA	4		
38	710132		Remove Culvert	LF	405		
39	710155		Remove Concrete Headwalls, Wingwalls and Apron at Outlet	LS	1		
40	720000	F	Engineered Streambed Material	CY	180		
41	723017	F	Rock Slope Protection (Class VIII & IX, Method A) (Weirs)	CY	150		
42	723035	F	Rock Slope Protection-Roughened Channel (Class VII & IX)	CY	45		
43	723050		Rock Slope Protection (1/4 T, Class V, Method B) (CY)	CY	152		
44	750500		Miscellaneous Metal (Inlet Grate, 24-12X Galvanized)	LBS	956		
45	770200		Repair Water Line	LS	1		
46	832006		Midwest Guardrail System (Steel Post)	LF	75		
47	839581		End Anchor Assembly (Type SFT)	EA	1		
48	839585		Alternative Flared Terminal System	EA	1		
49	840656		Paint Traffic Stripe (2 coat)	LF	860		
50	999990		Mobilization	LS	1		

NOTE: ITEM CODE LETTER DESIGNATION; P=PARTIAL PAY, F=FINAL PAY QUANTITY

BID TOTAL

--

ACKNOWLEDGEMENT OF ADDENDA

<u>ADDENDUM NO.</u>	<u>INITIAL</u>
_____	_____
_____	_____
_____	_____

(Bidder's Signature)

(Title)



BAR IS ONE INCH ON ORIGINAL DRAWING

IF NOT ONE INCH ON THIS SHEET, ADJUST SCALES ACCORDINGLY

ROAD NAME: VARIOUS
 ROAD NO.: VARIOUS MILE POST: VARIOUS
 PROJECT NO.: FEMA 4308 & 4434
 CONTRACT NO.: VARIOUS
 DRAWING FILE NAME: 217XXX CDSN 002
 PLOT DATE: 06/08/2021 REVISION DATE: 06/22/2021

DESIGN SECTION
 ENGINEERING
 DESIGNED BY: JB/MS
 DRAWN BY: RMD
 REVIEWED BY: JAB
 APPROVED BY: TRS

COUNTY OF HUMBOLDT Attachment 1
 DEPARTMENT OF PUBLIC WORKS
 STORM DAMAGE REPAIR TO TELEGRAPH CRK RD & PUMA DRV
 PROJECT QUANTITIES BY LOCATION

SHEET
 2
 OF
 31

LEGEND

1 ADDENDUM NO. 1

PROJECT QUANTITIES BY LOCATION

ITEM NO.	ITEM CODE	ITEM DESCRIPTION	UNIT	Telegraph Crk Rd PM 1.90	Puma Drv PM 0.1	Puma Drv PM 0.21	Puma Drv PM 0.25	Puma Drv PM 0.60	Total
1	038391	Fish Habitat Structure - Root Wad	EA	2	0	0	0	0	2
2	120090	Construction Area Signs	EA	10	1	1	1	1	14
3	120100	Traffic Control System	LS	0.50	0.20	0.10	0.10	0.10	1
4	128651	Portable Changeable Message Sign	EA	1	0	0	0	0	1
5	130100	Job Site Management	LS	0.50	0.20	0.10	0.10	0.10	1
6	130200	Prepare Water Pollution Control Program	LS	0.50	0.20	0.10	0.10	0.10	1
7	130900	Temporary Concrete Washout	EA	1	0	0	0	0	1
8	131201	Temporary Creek Diversion System	LS	1	0	0	0	0	1
9	150200	Remove Temporary Railroad Flatcar Bridge	LS	1	0	0	0	0	1
10	170103	Clearing and Grubbing (LS)	LS	0.50	0.20	0	0.30	0	1
11	190101	Roadway Excavation	CY	142	63	50	42	230	527
12	192025	F Structure Excavation (Culvert & Channel)	CY	3,080	0	0	0	0	3,080
13	192037	F Structure Excavation (Retaining Wall)	CY	0	643	0	0	0	643
14	193004	F Structure Backfill (Culvert)	CY	510	0	0	0	0	510
15	193013	F Structure Backfill (WWW Retaining Wall)	CY	0	460	0	0	0	460
16	198050	F Embankment	CY	1,380	312	0	0	0	1,692
17	210212	Dry Seed (SQFT)	SQFT	6,005	726	0	3,380	0	10,111
18	210280	Rolled Erosion Control Product (Blanket)	SQYD	348	517	0	0	0	865
19	210350	Fiber Rolls	LF	460	0	0	0	0	460
20	210420	Straw	SQFT	2,875	209	0	3,380	0	6,464
21	210500	Willow Stakes	EA	200	0	0	0	0	200
22	210501	Alder Tree	EA	24	0	0	0	0	24
23	260203	F Class 2 Aggregate Base (CY)	CY	147	77	11	13	193	441
24	390132	Hot Mix Asphalt (Type A)	TON	110	46	8	14	131	309
25	394073	Hot Mix Asphalt Dike Type A	LF	440	0	0	0	0	440
26	477020	F Mechanically Stabilized Embankment (Wire Wall)	SQFT	0	944	0	0	0	944
27	510091	F Structural Concrete (Arch Culvert-Footings)	CY	104	0	0	0	0	104
28	510092	F Structural Concrete (Headwall & Wingwalls)	CY	114	0	0	0	0	114
29	510502	Minor Concrete, Minor Structure (Drainage Inlets, Junction Structure)	EA	1	1	0	2	0	4
30	520101	F Bar Reinforcing Steel	LBS	17,560	0	0	0	0	17,560
31	641107	18" Plastic Pipe (Heat-Fused HDPE)	LF	30	64	0	340	0	434
32	674960	P 22"x8'-11" Structural Plate, Arch Culvert (0.170 in, 8 Ga.)	LF	70	0	0	0	0	70
33	680902	6" Perforated Plastic Pipe Underdrain	LF	0	108	0	0	0	108
34	680903	6" Non-Perforated Plastic Pipe Underdrain	LF	0	31	0	0	0	31
35	681132	Geocomposite Drain	SQFT	0	912	0	0	0	912
36	682023	Class 1 Permeable Material (Type B)	CY	0	95	0	0	0	95
37	692381	Concrete Anchor and Cable Assembly	EA	1	1	0	2	0	4
38	710132	Remove Culvert	LF	100	80	0	225	0	405
39	710155	Remove Concrete Headwalls, Wingwalls and Apron at Outlet	LS	1	0	0	0	0	1
40	720000	F Engineered Streambed Material	CY	180	0	0	0	0	180
41	723017	F Rock Slope Protection (Class VIII & IX, Method A) (Weirs)	CY	150	0	0	0	0	150
42	723035	F Rock Slope Protection-Roughened Channel (Class VII & IX)	CY	45	0	0	0	0	45
43	723050	Rock Slope Protection (1/4 T, Class V, Method B) (CY)	CY	135	9	0	8	0	152
44	750500	Miscellaneous Metal (Inlet Grate, 24-12X Galvanized)	LBS	239	239	0	478	0	956
45	770200	Repair Water Line	LS	0	1	0	0	0	1
46	832006	Midwest Guardrail System (Steel Post)	LF	0	75	0	0	0	75
47	839581	End Anchor Assembly (Type SFT)	EA	0	1	0	0	0	1
48	839585	Alternative Flared Terminal System	EA	0	1	0	0	0	1
49	840656	Paint Traffic Stripe (2 coat)	LF	220	120	200	30	290	860
50	999990	Mobilization	LS	0.50	0.20	0.10	0.10	0.10	1

1
1



BAR IS ONE INCH ON ORIGINAL DRAWING	ROAD NAME: TELEGRAPH CREEK ROAD	DESIGN SECTION	COUNTY OF HUMBOLDT Attachment 1
	ROAD NO: 4A150	ENGINEERING	DEPARTMENT OF PUBLIC WORKS
	MILE POST: 1.90	DESIGNED BY: JB/MS	STORM DAMAGE REPAIR TO TELEGRAPH CRK RD & PUMA DRV
	PROJECT NO.: FEMA 4308 & 4434	DRAWN BY: RMD	TELEGRAPH CREEK RD PM 1.90
	CONTRACT NO.: 217345	REVIEWED BY: JAB	TYPICAL SECTIONS AND DETAILS
	DRAWING FILE NAME: 217XXX CDSN 004	APPROVED BY: TRS	
IF NOT ONE INCH ON THIS SHEET, ADJUST SCALES ACCORDINGLY	PLOT DATE: 06/08/2021	REVISION DATE: 06/22/2021	

COUNTY OF HUMBOLDT Attachment 1
 DEPARTMENT OF PUBLIC WORKS
 STORM DAMAGE REPAIR TO TELEGRAPH CRK RD & PUMA DRV
 TELEGRAPH CREEK RD PM 1.90
 TYPICAL SECTIONS AND DETAILS

SHEET
7
 OF
31

LEGEND
 1 ADDENDUM NO. 1

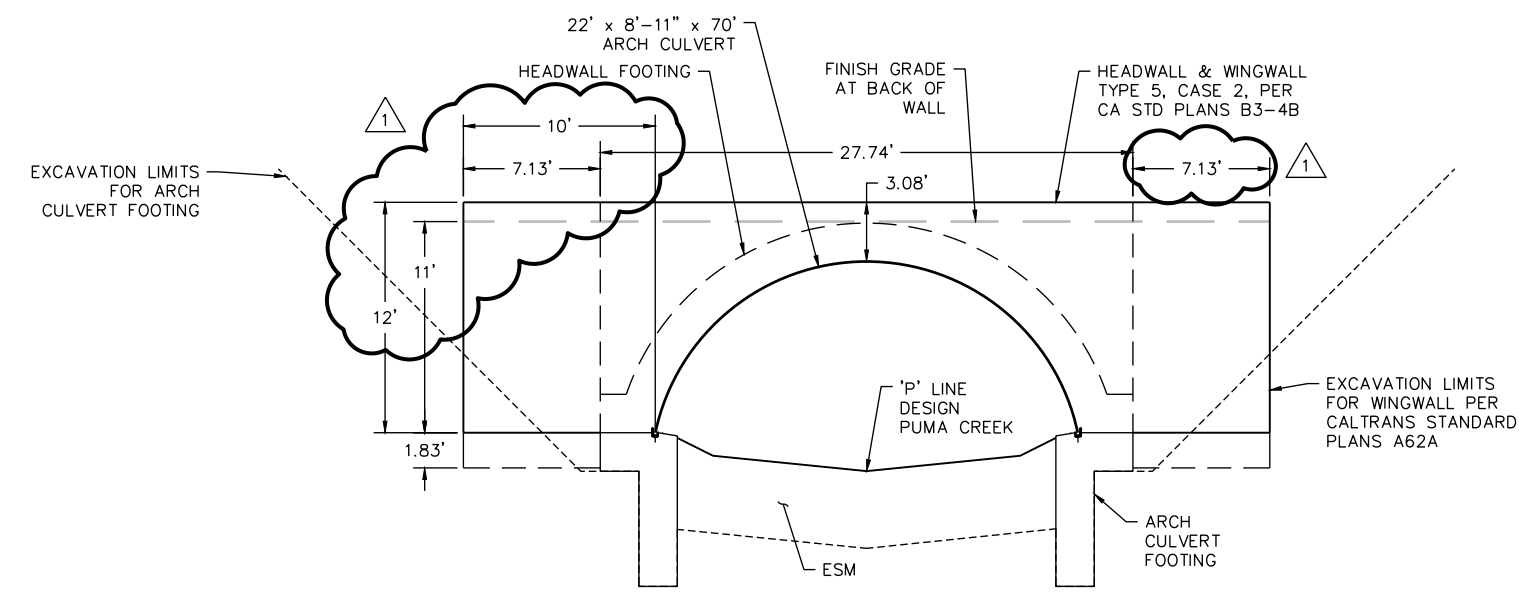

ARCH CULVERT INLET WITH HEADWALL AND WINGWALL
 SCALE: 1"=5'

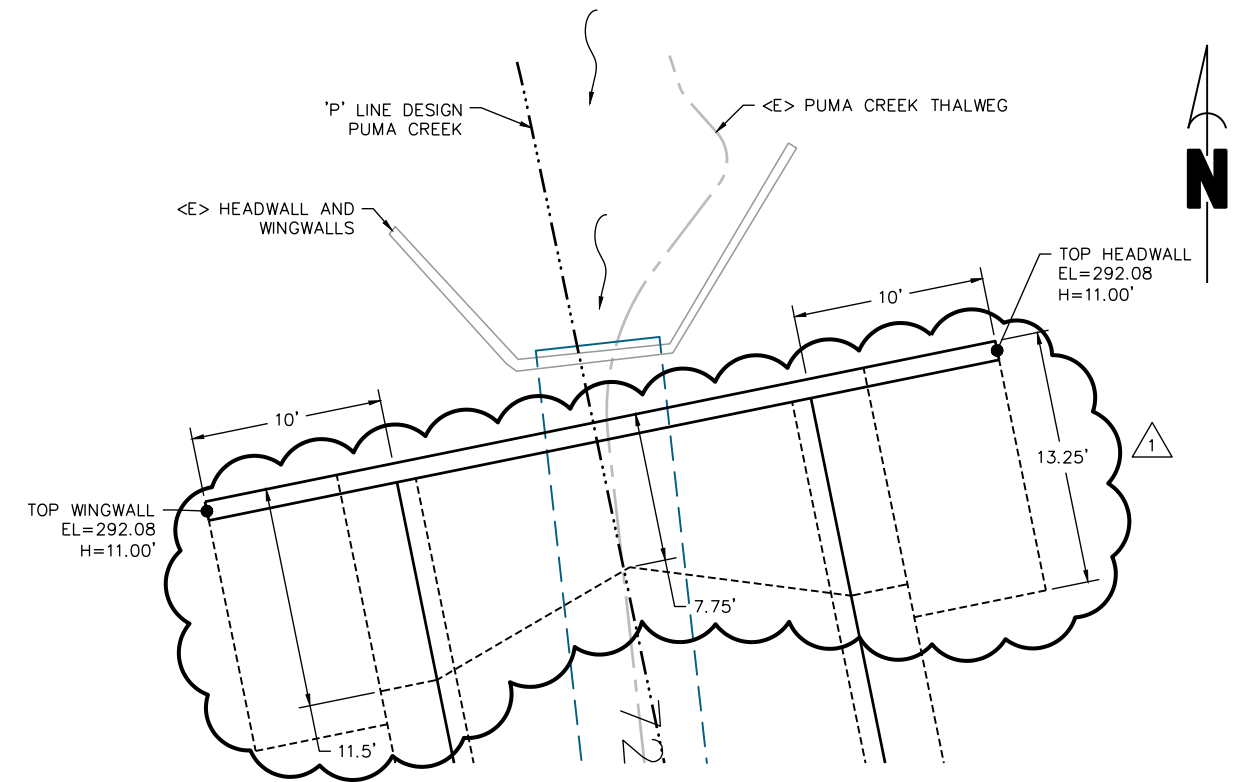

INLET WINGWALL LAYOUT
 SCALE: 1"=5'

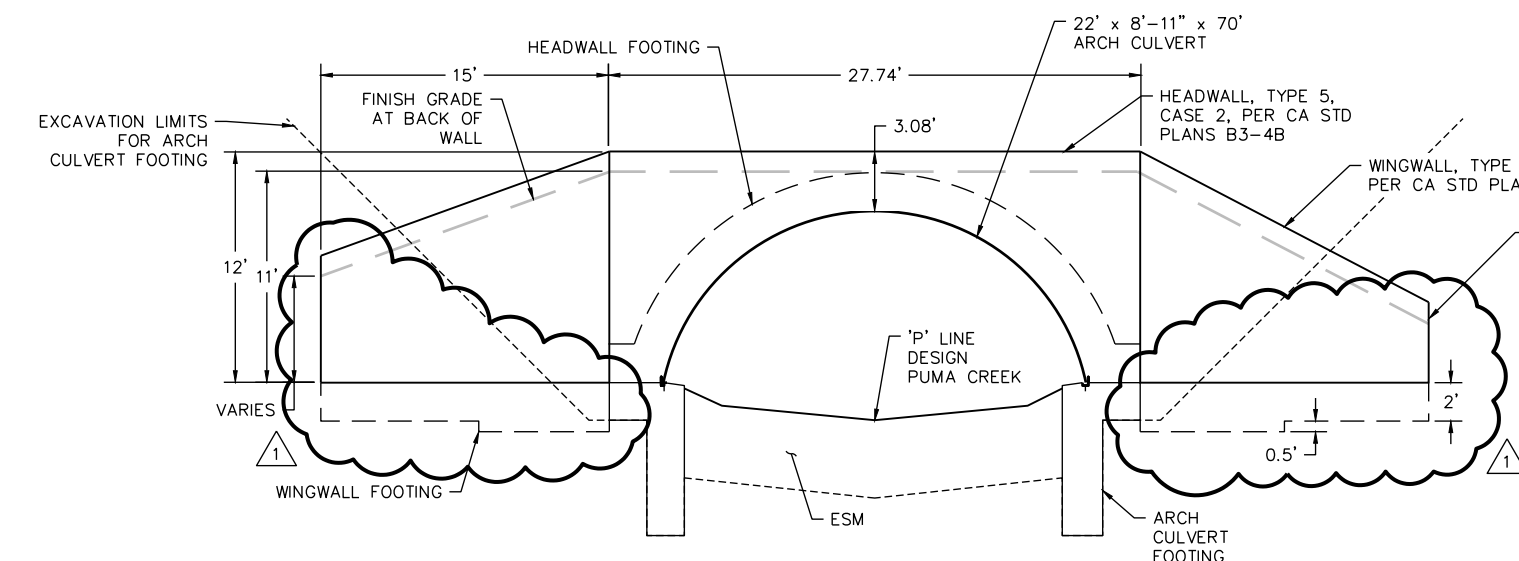

ARCH CULVERT OUTLET WITH HEADWALL AND WINGWALL
 SCALE: 1"=5'

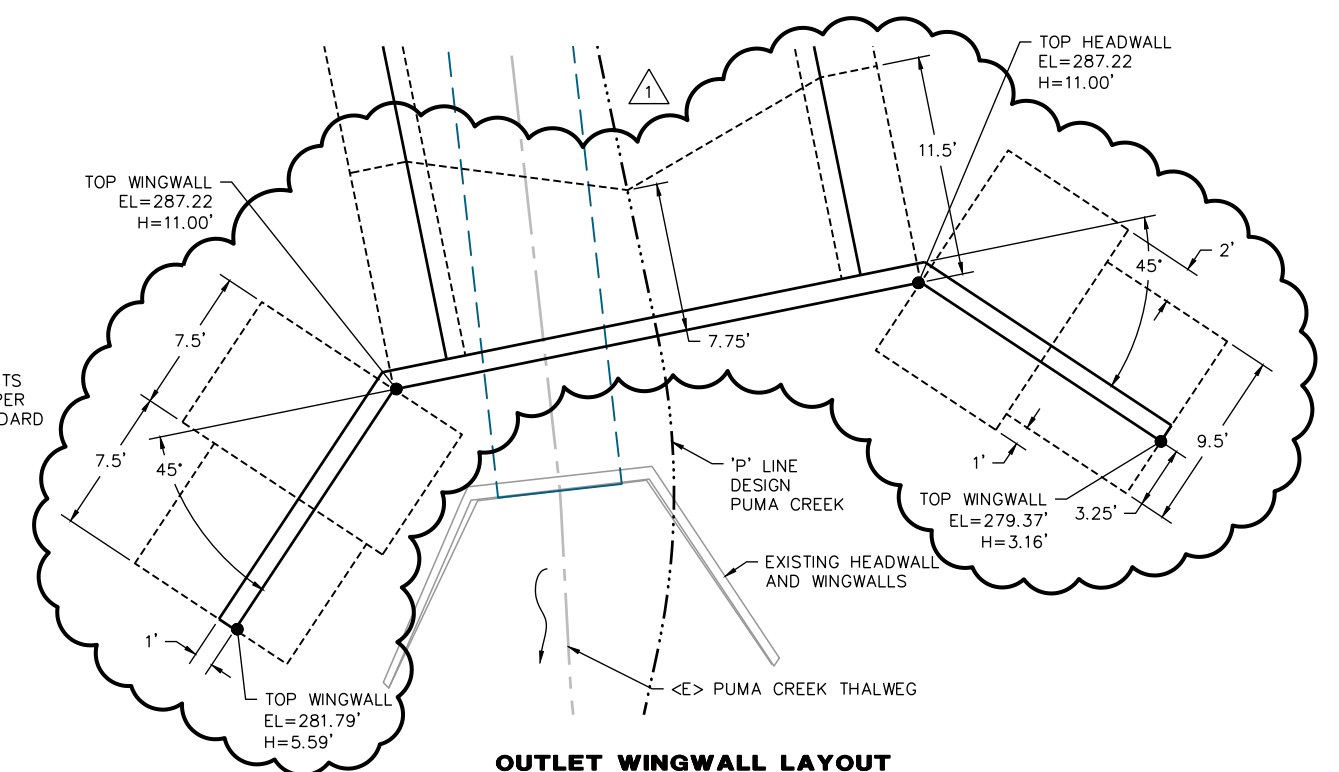

OUTLET WINGWALL LAYOUT
 SCALE: 1"=5'



BAR IS ONE INCH ON ORIGINAL DRAWING IF NOT ONE INCH ON THIS SHEET, ADJUST SCALES ACCORDINGLY	ROAD NAME: TELEGRAPH CREEK ROAD	DESIGN SECTION	COUNTY OF HUMBOLDT Attachment 1 DEPARTMENT OF PUBLIC WORKS STORM DAMAGE REPAIR TO TELEGRAPH CRK RD & PUMA DRV TELEGRAPH CREEK RD PM 1.90 TYPICAL SECTIONS AND DETAILS	
	ROAD NO.: 4A150	MILE POST: 1.90		ENGINEERING
	PROJECT NO.: FEMA 4308 & 4434			DESIGNED BY: JB/MS
	CONTRACT NO.: 217345			DRAWN BY: RMD
	DRAWING FILE NAME: 217XXX CDSN 004	REVIEWED BY: JAB		
	PLOT DATE: 06/08/2021	REVISION DATE: 06/22/2021	APPROVED BY: TRS	

SHEET
9
OF
31

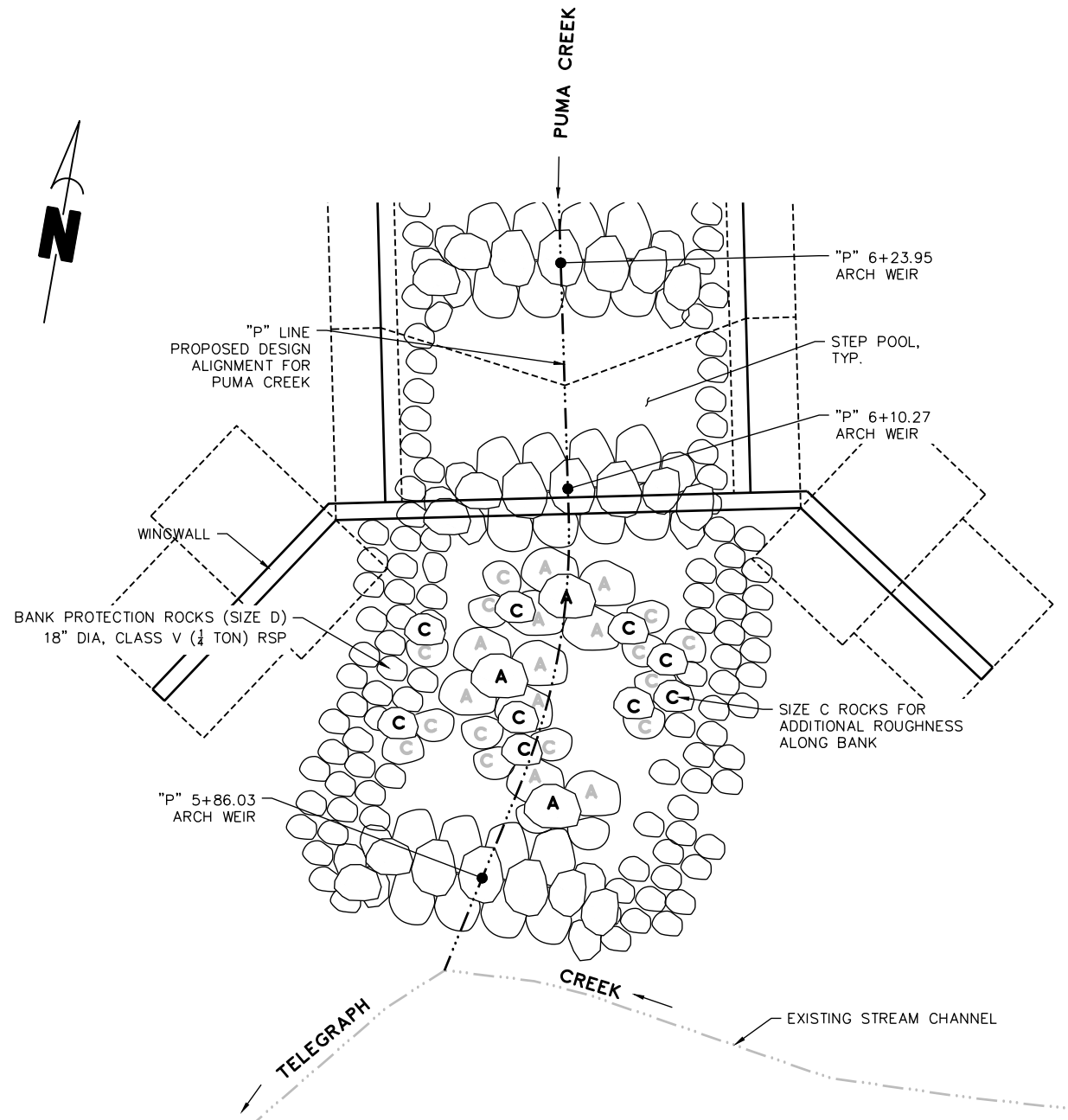

CASCADE ROUGHENED CHANNEL - OUTLET
'P' 5+79.69 TO 'P' 6+10.27

SCALE: 1"=5'

TABLE OF STRUCTURE ROCKS

	DOWNSTREAM (EACH)	UPSTREAM (EACH)	TOTAL (EACH)	TOTAL (TONS)	TOTAL (CY)**
SIZE A ROCKS, CLASS IX, 2 TON RSP	13	15	28	56	31.3
SIZE C ROCKS, CLASS VII, 1/2 TON RSP	22	18	40	20	11.2

**35% VOIDS, SG=2.87

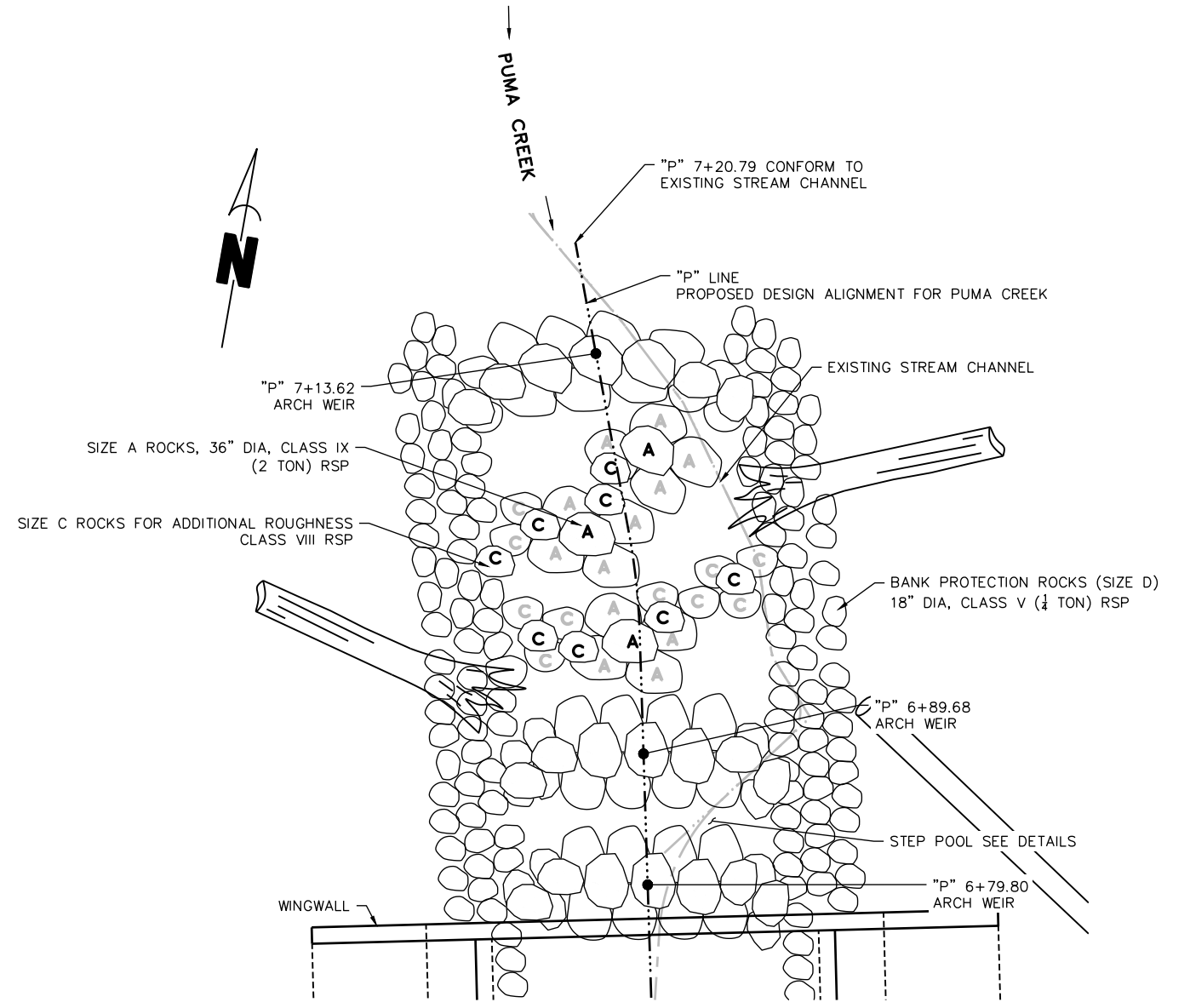

CASCADE ROUGHENED CHANNEL - INLET
'P' 6+89.68 TO 'P' 7+20.79

SCALE: 1"=5'

NOTES

- SEE CONSTRUCTION NOTES
- ROOT WAD LOCATIONS ARE APPROXIMATE
- EXCAVATION DAYLIGHTS NOT SHOWN



ROAD NAME: TELEGRAPH CREEK ROAD	DESIGN SECTION: ENGINEERING
ROAD NO.: 4A150	MILE POST: 1.90
PROJECT NO.: FEMA 4308 & 4434	DESIGNED BY: JB/MS
CONTRACT NO.: 217345	DRAWN BY: RMD
DRAWING FILE NAME: 217XXX CDSN 004	REVIEWED BY: JAB
PLOT DATE: 06/08/2021	REVISION DATE: 06/22/2021
	APPROVED BY: TRS

Attachment 1
COUNTY OF HUMBOLDT DEPARTMENT OF PUBLIC WORKS
STORM DAMAGE REPAIR TO TELEGRAPH CRK RD & PUMA DRV
TELEGRAPH CREEK RD PM 1.90 PUMA CREEK PLAN & PROFILE

SHEET
11
OF
31

LEGEND

1 ADDENDUM NO. 1

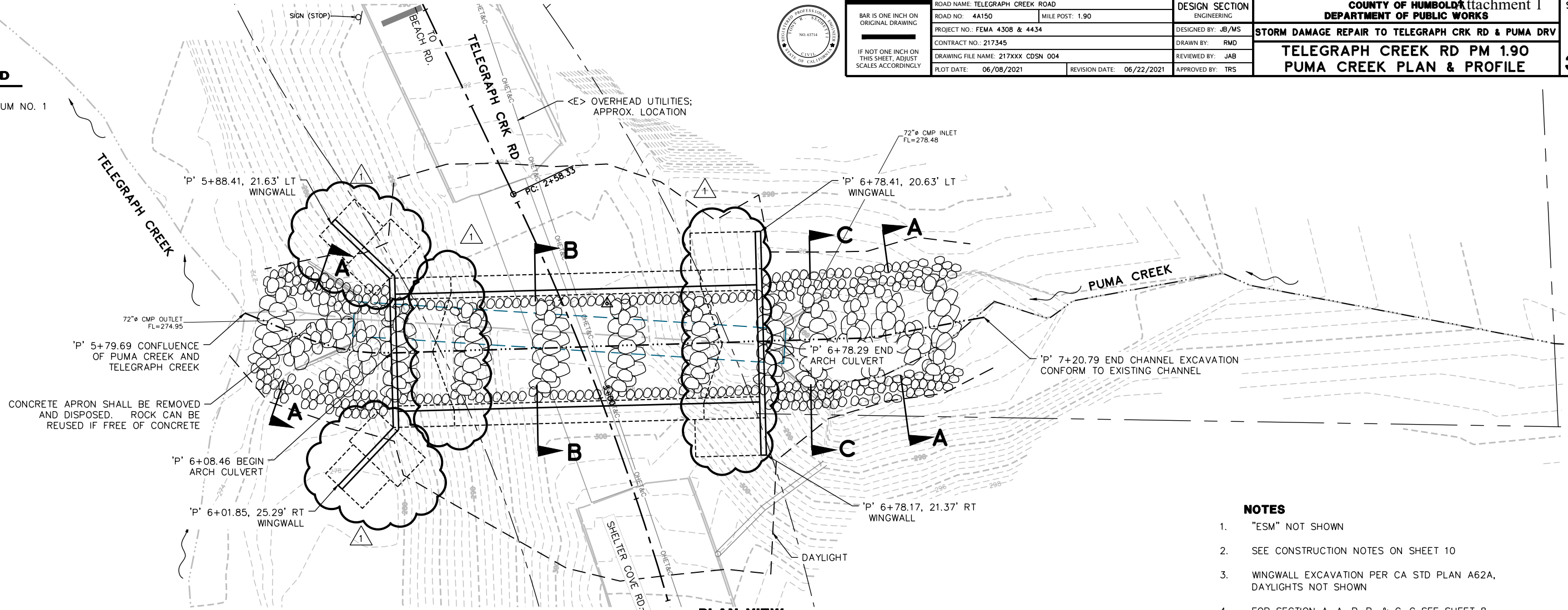

- NOTES**
- "ESM" NOT SHOWN
 - SEE CONSTRUCTION NOTES ON SHEET 10
 - WINGWALL EXCAVATION PER CA STD PLAN A62A, DAYLIGHTS NOT SHOWN
 - FOR SECTION A-A, B-B, & C-C SEE SHEET 8

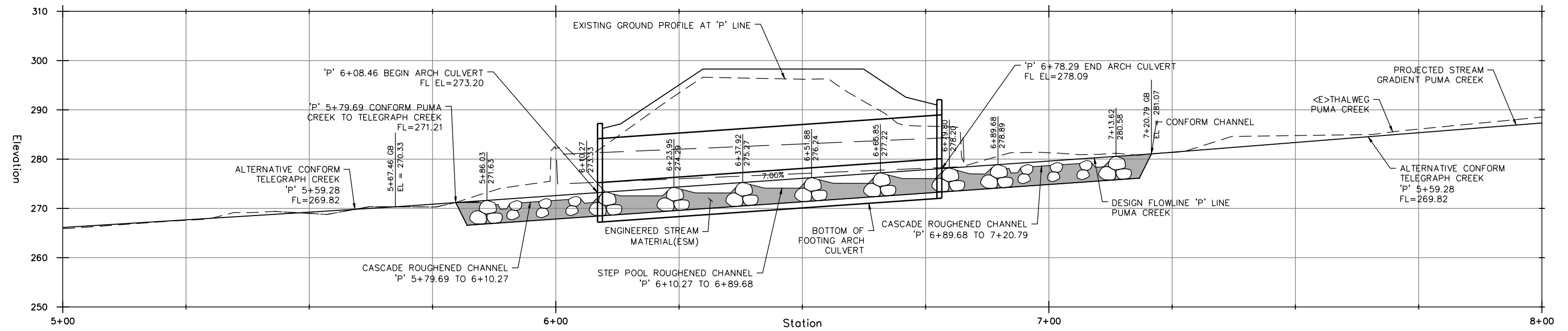



ROAD NAME: TELEGRAPH CREEK ROAD		DESIGN SECTION
ROAD NO.: 4A150	MILE POST: 1.90	ENGINEERING
PROJECT NO.: FEMA 4308 & 4434		DESIGNED BY: JB/MS
CONTRACT NO.: 217345		DRAWN BY: RMD
DRAWING FILE NAME: 217XXX CDSN 004		REVIEWED BY: JAB
PLOT DATE: 06/08/2021	REVISION DATE: 06/22/2021	APPROVED BY: TRS

COUNTY OF HUMBOLDT
DEPARTMENT OF PUBLIC WORKS
STORM DAMAGE REPAIR TO TELEGRAPH CRK RD & PUMA DRV
TELEGRAPH CREEK RD PM 1.90
PUMA CREEK CROSS SECTIONS

Attachment 1
SHEET
14
OF
31

LEGEND

△ ADDENDUM NO. 1

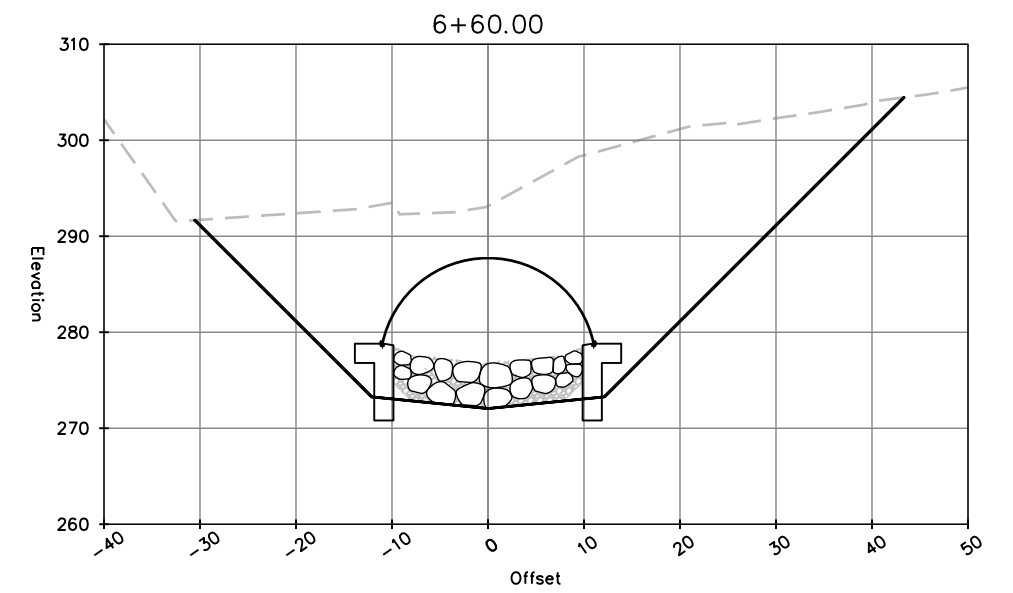
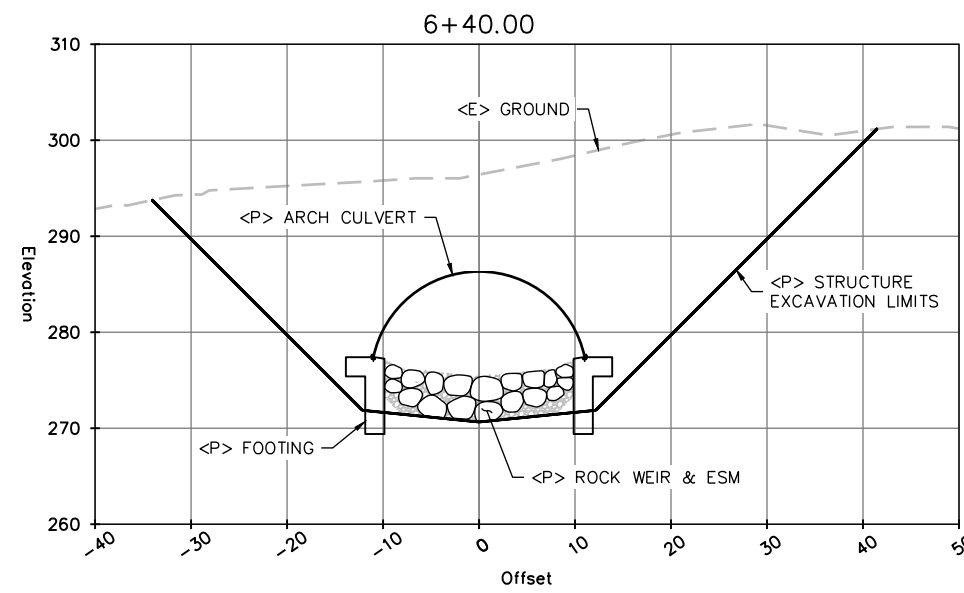
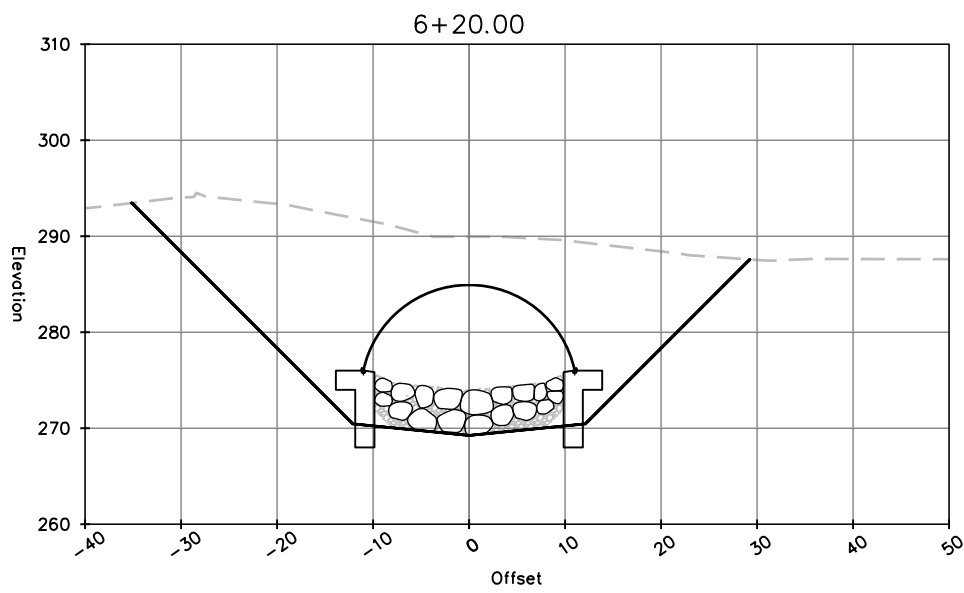
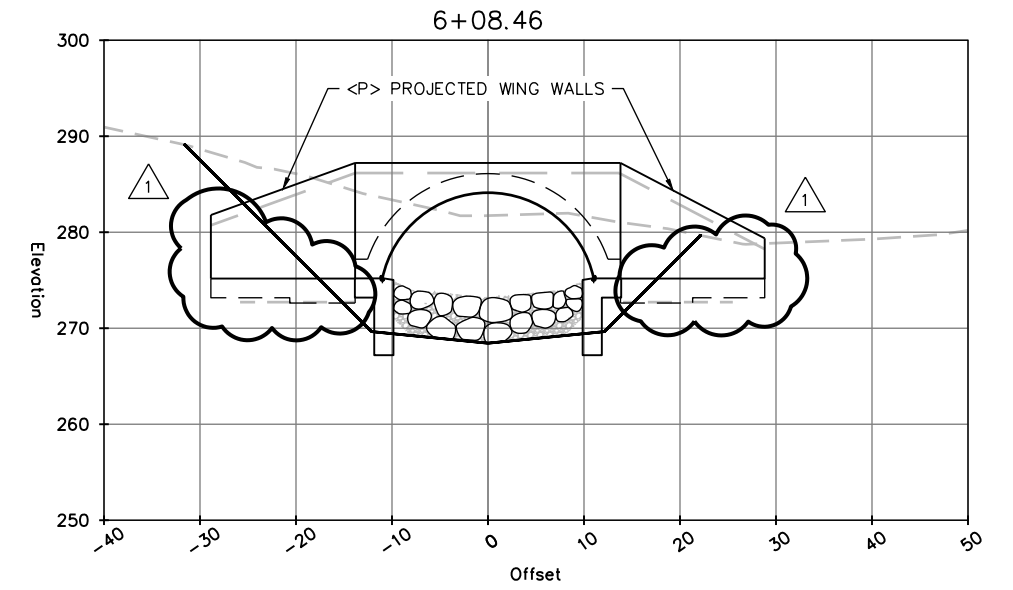
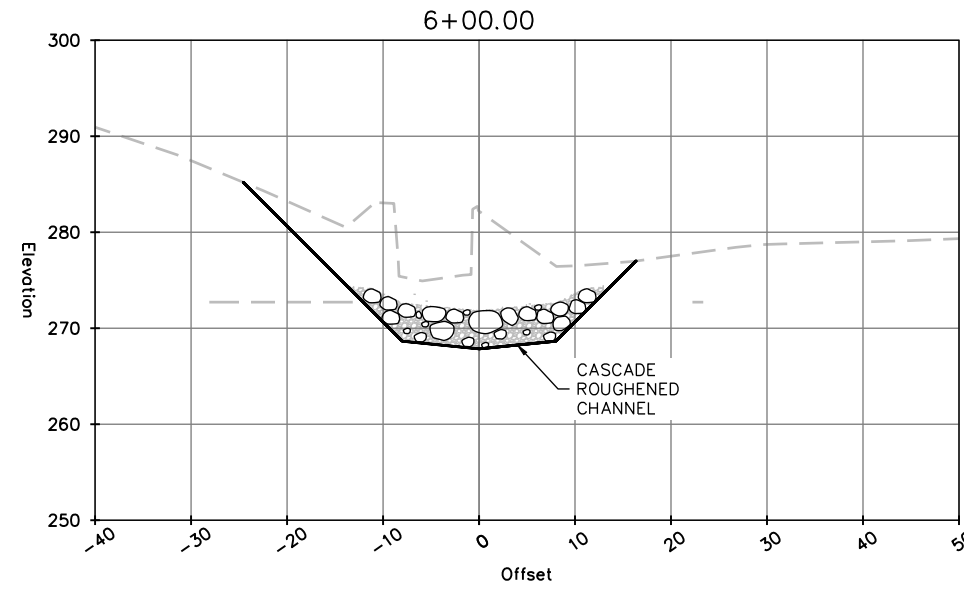
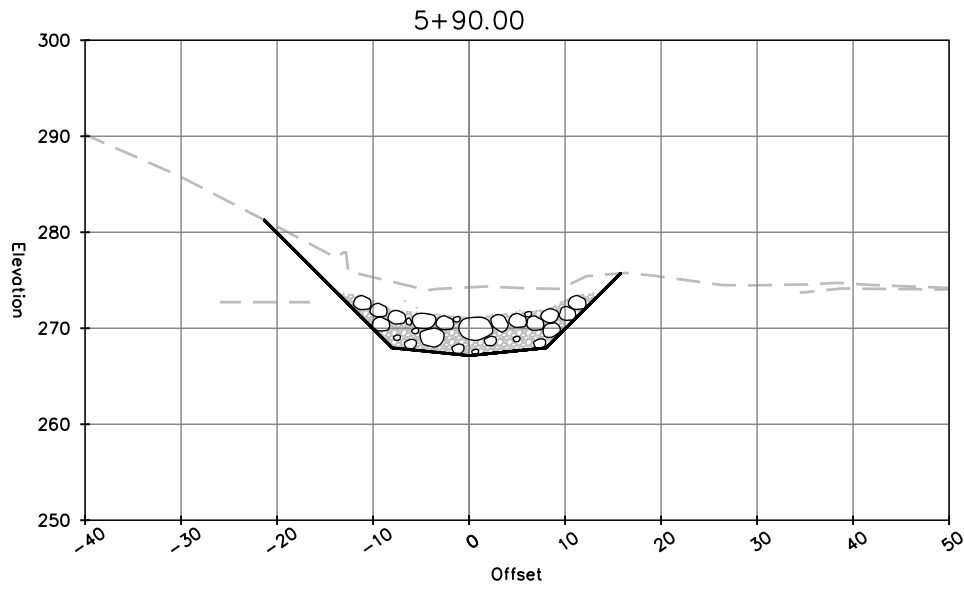

CROSS SECTIONS

SCALE: 1"=10' H,V



ROAD NAME: TELEGRAPH CREEK ROAD		DESIGN SECTION
ROAD NO.: 4A150	MILE POST: 1.90	ENGINEERING
PROJECT NO.: FEMA 4308 & 4434		DESIGNED BY: JB/MS
CONTRACT NO.: 217345		DRAWN BY: RMD
DRAWING FILE NAME: 217XXX_CDSN_004		REVIEWED BY: JAB
PLOT DATE: 06/08/2021	REVISION DATE: 06/22/2021	APPROVED BY: TRS

COUNTY OF HUMBOLDT Attachment 1
DEPARTMENT OF PUBLIC WORKS
STORM DAMAGE REPAIR TO TELEGRAPH CRK RD & PUMA DRV
TELEGRAPH CREEK RD PM 1.90
PUMA CREEK CROSS SECTIONS

SHEET
15
OF
31

LEGEND

△ ADDENDUM NO. 1

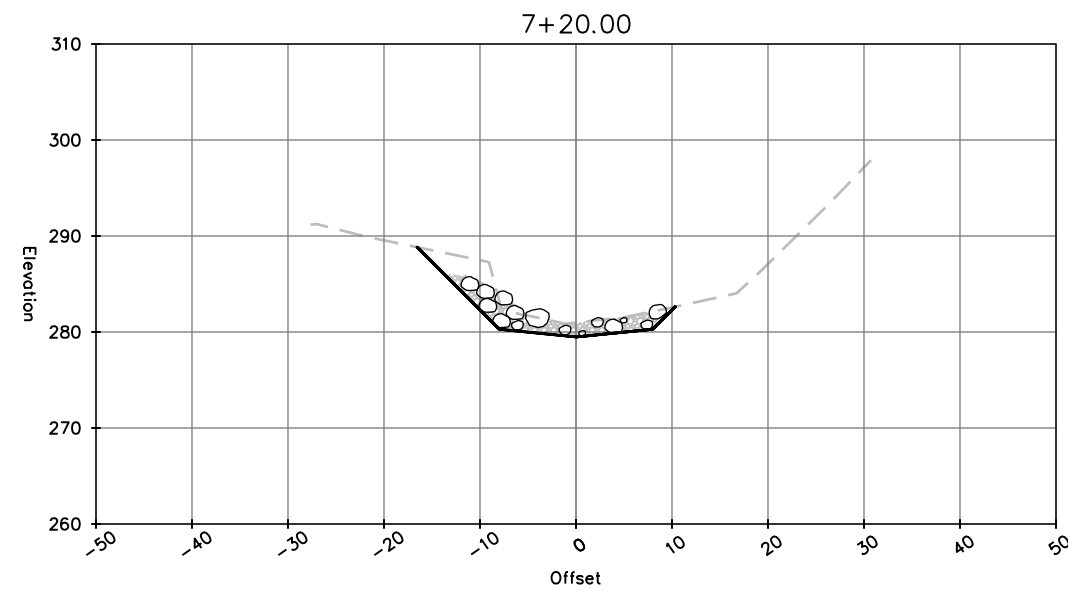
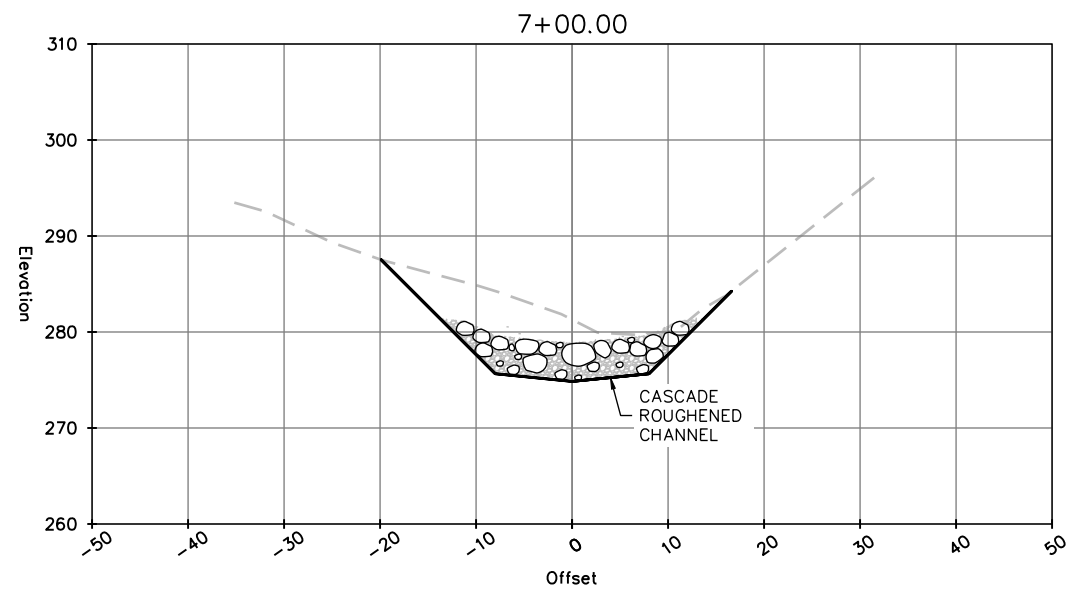
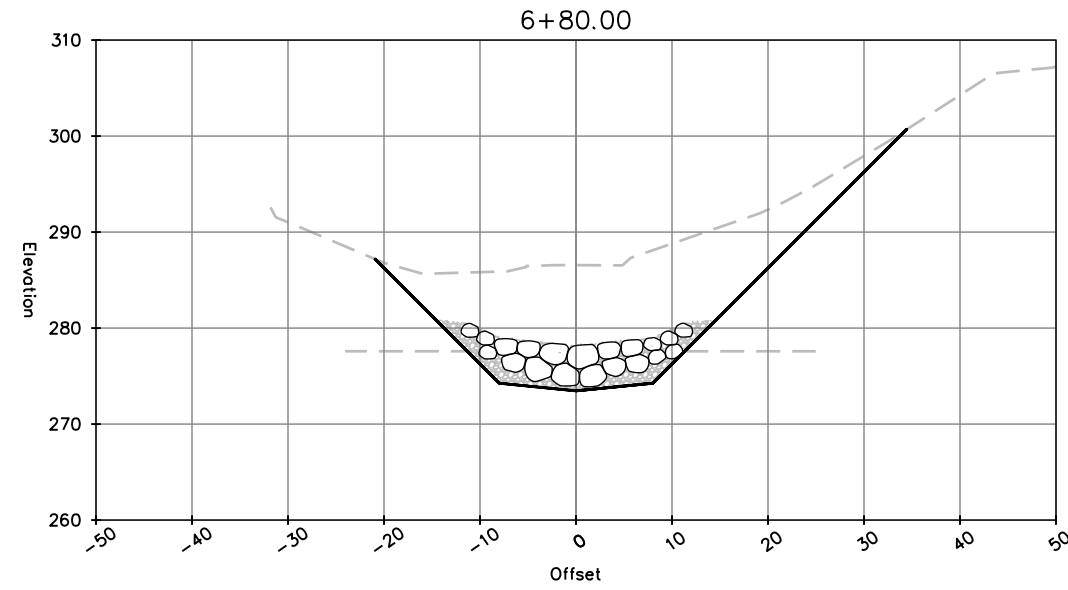
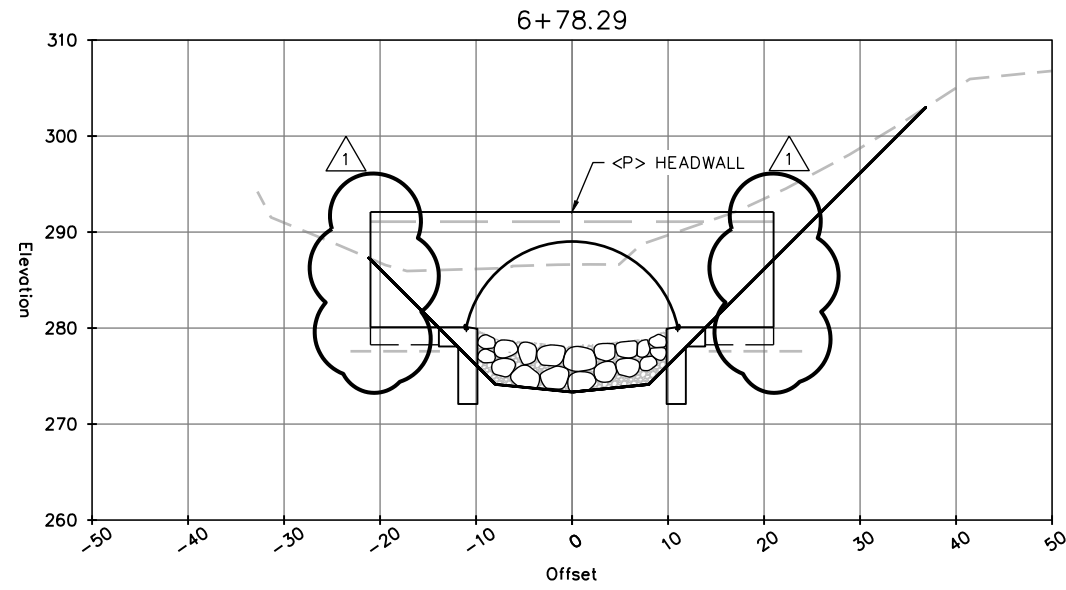

CROSS SECTIONS

SCALE: 1"=10' H,V



**County of Humboldt
Department of Public Works
1106 Second Street
Eureka, CA 95501
TEL (707) 445-7652**

ADDENDUM NO. 2
(Issued July 9, 2021)

**STORM DAMAGE REPAIR TO TELEGRAPH CREEK ROAD (4A150)
PM 1.90 AND PUMA DRIVE (4A125) PM 0.10, 0.21, 0.25, 0.60
PROJECT NO.: FEMA 4308-DR-CA PW-1433, PW-1309 AND 4434-DR-CA
PW-0212 CONTRACT NO.: 217345, 219342, 219343, 217541, 219346**

The Special Provisions and Plans are hereby modified in accordance with the following:

- 1. Per Section 7-1.11A of the Special Provisions, notice is hereby given that this contract is subject to the Federal Wage Rates as revised on 7/2/2021, General Decision Number: CA20210004 ("Revised Wage Rates"). Although the Revised Federal Wage Rates are not required to be physically included in the Bid Package, the Revised Wage Rates shall be included in the Agreement signed by the County of Humboldt and the Contractor. The Revised Wage Rates are available at the Humboldt County Department of Public Works located at 1106 2nd St. Eureka, CA 95501 or directly from the Department of Labor at <https://sam.gov/wage-determination/CA20210004/5#document>

Approved:

Jeffrey A. Ball

07/09/2021

Jeffrey A. Ball
RCE 70631, Expire 06/30/2023

Date

IMPORTANT

This Addendum is being sent EMAIL/FAX. To indicate receipt of this Addendum please sign and send back to the Department of Public Works.

EMAIL: PWEngineering@co.humboldt.ca.us
or FAX: (707) 445-7409

Received by:

GARY

Date

7-9-21

Company:

G.R. WILCOX

Pages

Received

1

Total Pages Sent 1

Replace section 7-1.11B with:**CONTRACT PROVISIONS FEDERAL-AID CONSTRUCTION CONTRACTS**
(Required Federal Language)

FHWA-1273 -- Revised May 1, 2012

- I. General
- II. Nondiscrimination
- III. Nonsegregated Facilities
- IV. Davis-Bacon and Related Act Provisions
- V. Contract Work Hours and Safety Standards Act Provisions
- VI. Subletting or Assigning the Contract
- VII. Safety: Accident Prevention
- VIII. False Statements Concerning Highway Projects
- IX. Implementation of Clean Air Act and Federal Water Pollution Control Act
- X. Compliance with Government wide Suspension and Debarment Requirements
- XI. Certification Regarding Use of Contract Funds for Lobbying

ATTACHMENTS

A. Employment and Materials Preference for Appalachian Development Highway System or Appalachian Local Access Road Contracts (included in Appalachian contracts only)

I. GENERAL

1. Form FHWA-1273 must be physically incorporated in each construction contract funded under Title 23 (excluding emergency contracts solely intended for debris removal). The contractor (or subcontractor) must insert this form in each subcontract and further require its inclusion in all lower tier subcontracts (excluding purchase orders, rental agreements and other agreements for supplies or services).

The applicable requirements of Form FHWA-1273 are incorporated by reference for work done under any purchase order, rental agreement or agreement for other services. The prime contractor shall be responsible for compliance by any subcontractor, lower-tier subcontractor or service provider.

Form FHWA-1273 must be included in all Federal-aid design-build contracts, in all subcontracts and in lower tier subcontracts (excluding subcontracts for design services, purchase orders, rental agreements and other agreements for supplies or services). The design-builder shall be responsible for compliance by any subcontractor, lower-tier subcontractor or service provider.

Contracting agencies may reference Form FHWA-1273 in bid proposal or request for proposal documents, however, the Form FHWA-1273 must be physically incorporated (not referenced) in all contracts, subcontracts and lower-tier subcontracts (excluding purchase orders, rental agreements

and other agreements for supplies or services related to a construction contract).

2. Subject to the applicability criteria noted in the following sections, these contract provisions shall apply to all work performed on the contract by the contractor's own organization and with the assistance of workers under the contractor's immediate superintendence and to all work performed on the contract by piecework, station work, or by subcontract.

3 A breach of any of the stipulations contained in these Required Contract Provisions may be sufficient grounds for withholding of progress payments, withholding of final payment, termination of the contract, suspension / debarment or any other action determined to be appropriate by the contracting agency and FHWA

4 Selection of Labor During the performance of this contract, the contractor shall not use convict labor for any purpose within the limits of a construction project on a Federal-aid highway unless it is labor performed by convicts who are on parole, supervised release, or probation The term Federal-aid highway does not include roadways functionally classified as local roads or rural minor collectors

II. NONDISCRIMINATION

The provisions of this section related to 23 CFR Part 230 are applicable to all Federal-aid construction contracts and to all related construction subcontracts of \$10,000 or more The provisions of 23 CFR Part 230 are not applicable to material supply, engineering, or architectural service contracts

In addition, the contractor and all subcontractors must comply with the following policies Executive Order 11 246, 41 CFR 60, 29 CFR 1625-1627, Title 23 USC Section 140, the Rehabilitation Act of 1 973, as amended (29 USC 794), Title VI of the Civil Rights Act of 1964, as amended, and related regulations including 49 CFR Parts 21, 26 and 27, and 23 CFR Parts 200, 230, and 633

The contractor and all subcontractors must comply with: the requirements of the Equal Opportunity Clause in 41 CFR 60-1.4(b) and, for all construction contracts exceeding \$10,000, the Standard Federal Equal Employment Opportunity Construction Contract Specifications in 41 CFR 60-4.3.

Note The U S Department of Labor has exclusive authority to determine compliance with Executive Order 11246 and the policies of the Secretary of Labor including 41 CFR 60, and 29 CFR 1625-1627 The contracting agency and the FHWA have the authority and the responsibility to ensure compliance with

Title 23 USC Section 140, the Rehabilitation Act of 1973, as amended (29 USC 794), and Title VI of the Civil Rights Act of 1964, as amended, and related regulations including 49 CFR Parts 21, 26 and 27, and 23 CFR Parts 200, 230, and 633. The following provision is adopted from 23 CFR 230, Appendix A, with appropriate revisions to conform to the U S Department of Labor (US DOL) and FHWA requirements.

1. Equal Employment Opportunity: Equal employment opportunity (EEO) requirements not to discriminate and to take affirmative action to assure equal opportunity as set forth under laws, executive orders, rules, regulations (28 CFR 35, 29 CFR 1630, 29 CFR 1625-1627, 41 CFR 60 and 49 CFR 27) and orders of the Secretary of Labor as modified by the provisions prescribed herein, and imposed pursuant to 23 U.S.C. 140 shall constitute the EEO and specific affirmative action standards for the contractor's project activities under this contract. The provisions of the Americans with Disabilities Act of 1990 (42 U.S.C. 12101 et seq.) set forth under 28 CFR 35 and 29 CFR 1630 are incorporated by reference in this contract. In the execution of this contract, the contractor agrees to comply with the following minimum specific requirement activities of EEO:

a. The contractor will work with the contracting agency and the Federal Government to ensure that it has made every good faith effort to provide equal opportunity with respect to all of its terms and conditions of employment and in their review of activities under the contract.

b. The contractor will accept as its operating policy the following statement:

"It is the policy of this Company to assure that applicants are employed, and that employees are treated during employment, without regard to their race, religion, sex, color, national origin, age or disability. Such action shall include: employment, upgrading, demotion, or transfer; recruitment or recruitment advertising; layoff or termination; rates of pay or other forms of compensation; and selection for training, including apprenticeship, pre-apprenticeship, and/or on-the-job training.

2. EEO Officer: The contractor will designate and make known to the contracting officers an EEO Officer who will have the responsibility for and must be capable of effectively administering and promoting an active EEO program and who must be assigned adequate authority and responsibility to do so.

3. Dissemination of Policy: All members of the contractor's staff who are authorized to hire, supervise, promote, and discharge employees, or who recommend such action, or who are substantially involved in such action, will be made fully cognizant of, and will implement, the contractor's EEO policy and contractual responsibilities to provide EEO in each grade and classification of employment. To ensure that the above agreement will be met, the following actions will be taken as a minimum:

a. Periodic meetings of supervisory and personnel office employees will be conducted before the start of work and then not less often than once every six months, at which time the contractor's EEO policy and its implementation will be reviewed and explained. The meetings will be conducted by the EEO Officer.

b. All new supervisory or personnel office employees will be given a thorough indoctrination by the EEO Officer, covering all major aspects of the contractor's EEO obligations within thirty days following their reporting for duty with the contractor.

c. All personnel who are engaged in direct recruitment for the project will be instructed by the EEO Officer in the contractor's procedures for locating and hiring minorities and women.

d. Notices and posters setting forth the contractor's EEO policy will be placed in areas readily accessible to employees, applicants for employment and potential employees.

e. The contractor's EEO policy and the procedures to implement such policy will be brought to the attention of employees by means of meetings, employee handbooks, or other appropriate means.

4. Recruitment: When advertising for employees, the contractor will include in all advertisements for employees the notation: "An Equal Opportunity Employer." All such advertisements will be placed in publications having a large circulation among minorities and women in the area from which the project work force would normally be derived.

a. The contractor will, unless precluded by a valid bargaining agreement, conduct systematic and direct recruitment through public and private employee referral sources likely to yield qualified minorities and women. To meet this requirement, the contractor will identify sources of potential minority group employees, and establish with such identified sources procedures whereby minority and women applicants may be referred to the contractor for employment consideration.

b. In the event the contractor has a valid bargaining agreement providing for exclusive hiring hall referrals, the contractor is expected to observe the provisions of that agreement to the extent that the system meets the contractor's compliance with EEO contract provisions. Where implementation of such an agreement has the effect of discriminating against minorities or women, or obligates the contractor to do the same, such implementation violates Federal nondiscrimination provisions.

c. The contractor will encourage its present employees to refer minorities and women as applicants for employment. Information and procedures with regard to referring such applicants will be discussed with employees.

5. Personnel Actions: Wages, working conditions, and employee benefits shall be established and administered, and personnel actions of every type, including hiring, upgrading, promotion, transfer, demotion, layoff, and termination, shall be taken without regard to race, color, religion, sex, national origin, age or disability. The following procedures shall be followed:

a. The contractor will conduct periodic inspections of project sites to insure that working conditions and employee facilities do not indicate discriminatory treatment of project site personnel.

b. The contractor will periodically evaluate the spread of wages paid within each classification to determine any evidence of discriminatory wage practices.

c. The contractor will periodically review selected personnel actions in depth to determine whether there is evidence of discrimination. Where evidence is found, the contractor will promptly take corrective action. If the review indicates that the discrimination may

extend beyond the actions reviewed, such corrective action shall include all affected persons.

d. The contractor will promptly investigate all complaints of alleged discrimination made to the contractor in connection with its obligations under this contract, will attempt to resolve such complaints, and will take appropriate corrective action within a reasonable time. If the investigation indicates that the discrimination may affect persons other than the complainant, such corrective action shall include such other persons. Upon completion of each investigation, the contractor will inform every complainant of all of their avenues of appeal.

6. Training and Promotion:

a. The contractor will assist in locating, qualifying, and increasing the skills of minorities and women who are should be aimed at developing full journey level status employees in the type of trade or job classification involved.

b. Consistent with the contractor's work force requirements and as permissible under Federal and State regulations, the contractor shall make full use of training programs, i.e., apprenticeship, and on-the-job training programs for the geographical area of contract performance. In the event a special provision for training is provided under this contract, this subparagraph will be superseded as indicated in the special provision. The contracting agency may reserve training positions for persons who receive welfare assistance in accordance with 23 U.S.C. 140(a).

c. The contractor will advise employees and applicants for employment of available training programs and entrance requirements for each.

d. The contractor will periodically review the training and promotion potential of employees who are minorities and women and will encourage eligible employees to apply for such training and promotion.

7. Unions: If the contractor relies in whole or in part upon unions as a source of employees, the contractor will use good faith efforts to obtain the cooperation of such unions to increase opportunities for minorities and women. Actions by the contractor, either directly or through a contractor's association acting as agent, will include the procedures set forth below:

a. The contractor will use good faith efforts to develop, in cooperation with the unions, joint training programs aimed toward qualifying more minorities and women for membership in the unions and increasing the skills of minorities and women so that they may qualify for higher paying employment.

b. The contractor will use good faith efforts to incorporate an EEO clause into each union agreement to the end that such union will be contractually bound to refer applicants without regard to their race, color, religion, sex, national origin, age or disability.

c. The contractor is to obtain information as to the referral practices and policies of the labor union except that to the extent such information is within the exclusive possession of the labor union and such labor union refuses to furnish such information to the contractor, the contractor shall so certify to the contracting agency and shall set forth what efforts have been made to obtain such information.

d. In the event the union is unable to provide the contractor with a reasonable flow of referrals within the time limit set forth in the collective bargaining agreement, the contractor will, through independent recruitment efforts, fill the employment vacancies without regard to race, color, religion, sex, national origin, age or disability; making full efforts to obtain qualified and/or qualifiable minorities and women. The failure of a union to provide sufficient referrals (even though it is obligated to provide exclusive referrals under the terms of a collective bargaining agreement) does not relieve the contractor from the requirements of this paragraph. In the event the union referral practice prevents the contractor from meeting the obligations pursuant to Executive Order 11246, as amended, and these special provisions, such contractor shall immediately notify the contracting agency.

8. Reasonable Accommodation for Applicants / Employees with Disabilities:

The contractor must be familiar with the requirements for and comply with the Americans with Disabilities Act and all rules and regulations established there under. Employers must provide reasonable accommodation in all employment activities unless to do so would cause an undue hardship.

9. Selection of Subcontractors, Procurement of Materials and Leasing of Equipment:

The contractor shall not discriminate on the grounds of race, color, religion, sex, national origin, age or disability in the selection and retention of subcontractors, including procurement of materials and leases of equipment. The contractor shall take all necessary and reasonable steps to ensure nondiscrimination in the administration of this contract.

a. The contractor shall notify all potential subcontractors and suppliers and lessors of their EEO obligations under this contract.

b. The contractor will use good faith efforts to ensure subcontractor compliance with their EEO obligations.

10. Assurance Required by 49 CFR 26.13(b):

a. The requirements of 49 CFR Part 26 and the State DOT's U.S. DOT-approved DBE program are incorporated by reference.

b. The contractor or subcontractor shall not discriminate on the basis of race, color, national origin, or sex in the performance of this contract. The contractor shall carry out applicable requirements of 49 CFR Part 26 in the award and administration of DOT-assisted contracts. Failure by the contractor to carry out these requirements is a material breach of this contract, which may result in the termination of this contract or such other remedy as the contracting agency deems appropriate.

11. Records and Reports:

The contractor shall keep such records as necessary to document compliance with the EEO requirements. Such records shall be retained for a period of three years following the date of the final payment to the contractor for all contract work and shall be available at reasonable times and places for inspection by authorized representatives of the contracting agency and the FHWA.

a. The records kept by the contractor shall document the following:

(1) The number and work hours of minority and non-minority group members and women employed in each work classification on the project;

(2) The progress and efforts being made in cooperation with unions, when applicable, to increase employment opportunities for minorities and women; and

(3) The progress and efforts being made in locating, hiring, training, qualifying, and upgrading minorities and women;

b. The contractors and subcontractors will submit an annual report to the contracting agency each July for the duration of the project, indicating the number of minority, women, and non-minority group employees currently engaged in each work classification required by the contract work. This information is to be reported on Form FHWA-1391. The staffing data should represent the project work force on board in all or any part of the last payroll period preceding the end of July. If on-the-job training is being required by special provision, the contractor will be required to collect and report training data. The employment data should reflect the work force on board during all or any part of the last payroll period preceding the end of July.

III. NONSEGREGATED FACILITIES

This provision is applicable to all Federal-aid construction contracts and to all related construction subcontracts of \$10,000 or more.

The contractor must ensure that facilities provided for employees are provided in such a manner that segregation on the basis of race, color, religion, sex, or national origin cannot result. The contractor may neither require such segregated use by written or oral policies nor tolerate such use by employee custom. The contractor's obligation extends further to ensure that its employees are not assigned to perform their services at any location, under the contractor's control, where the facilities are segregated. The term "facilities" includes waiting rooms, work areas, restaurants and other eating areas, time clocks, restrooms, washrooms, locker rooms, and other storage or dressing areas, parking lots, drinking fountains, recreation or entertainment areas, transportation, and housing provided for employees. The contractor shall provide separate or single-user restrooms and necessary dressing or sleeping areas to assure privacy between sexes.

IV. DAVIS-BACON AND RELATED ACT PROVISIONS

This section is applicable to all Federal-aid construction projects exceeding \$2,000 and to all related subcontracts and lower-tier subcontracts (regardless of subcontract size). The requirements apply to all projects located within the right-of-way of a roadway that is functionally classified as Federal-aid highway. This excludes roadways functionally classified as local roads or rural minor collectors, which are exempt. Contracting agencies may elect to apply these requirements to other projects.

The following provisions are from the U.S. Department of Labor regulations in 29 CFR 5.5 "Contract provisions and related matters" with minor revisions to conform to the FHWA-1273 format and FHWA program requirements.

1. Minimum wages

a. All laborers and mechanics employed or working upon the site of the work, will be paid unconditionally and not less often than once a week, and without subsequent deduction or rebate on any account

(except such payroll deductions as are permitted by regulations issued by the Secretary of Labor under the Copeland Act (29 CFR part 3)), the full amount of wages and bona fide fringe benefits (or cash equivalents thereof) due at time of payment computed at rates not less than those contained in the wage determination of the Secretary of Labor which is attached hereto and made a part hereof, regardless of any contractual relationship which may be alleged to exist between the contractor and such laborers and mechanics.

Contributions made or costs reasonably anticipated for bona fide fringe benefits under section 1(b)(2) of the Davis-Bacon Act on behalf of laborers or mechanics are considered wages paid to such laborers or mechanics, subject to the provisions of paragraph 1.d. of this section; also, regular contributions made or costs incurred for more than a weekly period (but not less often than quarterly) under plans, funds, or programs which cover the particular weekly period, are deemed to be constructively made or incurred during such weekly period. Such laborers and mechanics shall be paid the appropriate wage rate and fringe benefits on the wage determination for the classification of work actually performed, without regard to skill, except as provided in 29 CFR 5.5(a)(4). Laborers or mechanics performing work in more than one classification may be compensated at the rate specified for each classification for the time actually worked therein: Provided, That the employer's payroll records accurately set forth the time spent in each classification in which work is performed. The wage determination (including any additional classification and wage rates conformed under paragraph 1.b. of this section) and the Davis-Bacon poster (WH-1321) shall be posted at all times by the contractor and its subcontractors at the site of the work in a prominent and accessible place where it can be easily seen by the workers.

b.(1) The contracting officer shall require that any class of laborers or mechanics, including helpers, which is not listed in the wage determination and which is to be employed under the contract shall be classified in conformance with the wage determination. The contracting officer shall approve an additional classification and wage rate and fringe benefits therefore only when the following criteria have been met:

(i) The work to be performed by the classification requested is not performed by a classification in the wage determination; and

(ii) The classification is utilized in the area by the construction industry; and

(iii) The proposed wage rate, including any bona fide fringe benefits, bears a reasonable relationship to the wage rates contained in the wage determination.

(2) If the contractor and the laborers and mechanics to be employed in the classification (if known), or their representatives, and the contracting officer agree on the classification and wage rate (including the amount designated for fringe benefits where appropriate), a report of the action taken shall be sent by the contracting officer to the Administrator of the Wage and Hour Division, Employment Standards Administration, U.S. Department of Labor, Washington, DC 20210. The Administrator, or an authorized representative, will approve, modify, or disapprove every additional classification action within 30 days of receipt and so advise the contracting officer or will notify the contracting officer within the 30-day period that additional time is necessary.

(3) In the event the contractor, the laborers or mechanics to be employed in the classification or their representatives, and the contracting officer do not agree on the proposed classification and

wage rate (including the amount designated for fringe benefits, where appropriate), the contracting officer shall refer the questions, including the views of all interested parties and the recommendation of the contracting officer, to the Wage and Hour Administrator for determination. The Wage and Hour Administrator, or an authorized representative, will issue a determination within 30 days of receipt and so advise the contracting officer or will notify the contracting officer within the 30-day period that additional time is necessary.

(4) The wage rate (including fringe benefits where appropriate) determined pursuant to paragraphs 1.b.(2) or 1.b.(3) of this section, shall be paid to all workers performing work in the classification under this contract from the first day on which work is performed in the classification.

c. Whenever the minimum wage rate prescribed in the contract for a class of laborers or mechanics includes a fringe benefit which is not expressed as an hourly rate, the contractor shall either pay the benefit as stated in the wage determination or shall pay another bona fide fringe benefit or an hourly cash equivalent thereof.

d. If the contractor does not make payments to a trustee or other third person, the contractor may consider as part of the wages of any laborer or mechanic the amount of any costs reasonably anticipated in providing bona fide fringe benefits under a plan or program, Provided, That the Secretary of Labor has found, upon the written request of the contractor, that the applicable standards of the Davis-Bacon Act have been met. The Secretary of Labor may require the contractor to set aside in a separate account assets for the meeting of obligations under the plan or program.

2. Withholding

The contracting agency shall upon its own action or upon written request of an authorized representative of the Department of Labor, withhold or cause to be withheld from the contractor under this contract, or any other Federal contract with the same prime contractor, or any other federally-assisted contract subject to Davis-Bacon prevailing wage requirements, which is held by the same prime contractor, so much of the accrued payments or advances as may be considered necessary to pay laborers and mechanics, including apprentices, trainees, and helpers, employed by the contractor or any subcontractor the full amount of wages required by the contract. In the event of failure to pay any laborer or mechanic, including any apprentice, trainee, or helper, employed or working on the site of the work, all or part of the wages required by the contract, the contracting agency may, after written notice to the contractor, take such action as may be necessary to cause the suspension of any further payment, advance, or guarantee of funds until such violations have ceased.

3. Payrolls and basic records

a. Payrolls and basic records relating thereto shall be maintained by the contractor during the course of the work and preserved for a period of three years thereafter for all laborers and mechanics working at the site of the work. Such records shall contain the name, address, and social security number of each such worker, his or her correct classification, hourly rates of wages paid (including rates of contributions or costs anticipated for bona fide fringe benefits or cash equivalents thereof of the types described in section 1(b)(2)(B) of the Davis-Bacon Act), daily and weekly number of hours worked, deductions made and actual wages paid. Whenever the Secretary of Labor has found under 29 CFR 5.5(a)(1)(iv) that the wages of any laborer or mechanic include the amount of any costs reasonably anticipated in providing benefits under a plan or

program described in section 1(b)(2)(B) of the Davis-Bacon Act, the contractor shall maintain records which show that the commitment to provide such benefits is enforceable, that the plan or program is financially responsible, and that the plan or program has been communicated in writing to the laborers or mechanics affected, and records which show the costs anticipated or the actual cost incurred in providing such benefits. Contractors employing apprentices or trainees under approved programs shall maintain written evidence of the registration of apprenticeship programs and certification of trainee programs, the registration of the apprentices and trainees, and the ratios and wage rates prescribed in the applicable programs.

b.(1) The contractor shall submit weekly for each week in which any contract work is performed a copy of all payrolls to the contracting agency. The payrolls submitted shall set out accurately and completely all of the information required to be maintained under 29 CFR 5.5(a)(3)(i), except that full social security numbers and home addresses shall not be included on weekly transmittals. Instead the payrolls shall only need to include an individually identifying number for each employee (e.g., the last four digits of the employee's social security number). The required weekly payroll information may be submitted in any form desired. Optional Form WH-347 is available for this purpose from the Wage and Hour Division Web site at <http://www.dol.gov/esa/whd/forms/wh347instr.htm> or its successor site. The prime contractor is responsible for the submission of copies of payrolls by all subcontractors. Contractors and subcontractors shall maintain the full social security number and current address of each covered worker, and shall provide them upon request to the contracting agency for transmission to the State DOT, the FHWA or the Wage and Hour Division of the Department of Labor for purposes of an investigation or audit of compliance with prevailing wage requirements. It is not a violation of this section for a prime contractor to require a subcontractor to provide addresses and social security numbers to the prime contractor for its own records, without weekly submission to the contracting agency..

(2) Each payroll submitted shall be accompanied by a "Statement of Compliance," signed by the contractor or subcontractor or his or her agent who pays or supervises the payment of the persons employed under the contract and shall certify the following:

(i) That the payroll for the payroll period contains the information required to be provided under §5.5 (a)(3)(ii) of Regulations, 29 CFR part 5, the appropriate information is being maintained under §5.5 (a)(3)(i) of Regulations, 29 CFR part 5, and that such information is correct and complete;

(ii) That each laborer or mechanic (including each helper, apprentice, and trainee) employed on the contract during the payroll period has been paid the full weekly wages earned, without rebate, either directly or indirectly, and that no deductions have been made either directly or indirectly from the full wages earned, other than permissible deductions as set forth in Regulations, 29 CFR part 3;

(iii) That each laborer or mechanic has been paid not less than the applicable wage rates and fringe benefits or cash equivalents for the classification of work performed, as specified in the applicable wage determination incorporated into the contract.

(3) The weekly submission of a properly executed certification set forth on the reverse side of Optional Form WH-347 shall satisfy the requirement for submission of the "Statement of Compliance" required by paragraph 3.b.(2) of this section.

(4) The falsification of any of the above certifications may subject the contractor or subcontractor to civil or criminal prosecution under section 1001 of title 18 and section 231 of title 31 of the United States Code.

c. The contractor or subcontractor shall make the records required under paragraph 3.a. of this section available for inspection, copying, or transcription by authorized representatives of the contracting agency, the State DOT, the FHWA, or the Department of Labor, and shall permit such representatives to interview employees during working hours on the job. If the contractor or subcontractor fails to submit the required records or to make them available, the FHWA may, after written notice to the contractor, the contracting agency or the State DOT, take such action as may be necessary to cause the suspension of any further payment, advance, or guarantee of funds. Furthermore, failure to submit the required records upon request or to make such records available may be grounds for debarment action pursuant to 29 CFR 5.12.

4. Apprentices and trainees

a. Apprentices (programs of the USDOL).

Apprentices will be permitted to work at less than the predetermined rate for the work they performed when they are employed pursuant to and individually registered in a bona fide apprenticeship program registered with the U.S. Department of Labor, Employment and Training Administration, Office of Apprenticeship Training, Employer and Labor Services, or with a State Apprenticeship Agency recognized by the Office, or if a person is employed in his or her first 90 days of probationary employment as an apprentice in such an apprenticeship program, who is not individually registered in the program, but who has been certified by the Office of Apprenticeship Training, Employer and Labor Services or a State Apprenticeship Agency (where appropriate) to be eligible for probationary employment as an apprentice.

The allowable ratio of apprentices to journeymen on the job site in any craft classification shall not be greater than the ratio permitted to the contractor as to the entire work force under the registered program. Any worker listed on a payroll at an apprentice wage rate, who is not registered or otherwise employed as stated above, shall be paid not less than the applicable wage rate on the wage determination for the classification of work actually performed. In addition, any apprentice performing work on the job site in excess of the ratio permitted under the registered program shall be paid not less than the applicable wage rate on the wage determination for the work actually performed. Where a contractor is performing construction on a project in a locality other than that in which its program is registered, the ratios and wage rates (expressed in percentages of the journeyman's hourly rate) specified in the contractor's or subcontractor's registered program shall be observed.

Every apprentice must be paid at not less than the rate specified in the registered program for the apprentice's level of progress, expressed as a percentage of the journeymen hourly rate specified in the applicable wage determination. Apprentices shall be paid fringe benefits in accordance with the provisions of the apprenticeship program. If the apprenticeship program does not specify fringe benefits, apprentices must be paid the full amount of fringe benefits listed on the wage determination for the applicable classification. If the Administrator determines that a different

practice prevails for the applicable apprentice classification, fringes shall be paid in accordance with that determination.

In the event the Office of Apprenticeship Training, Employer and Labor Services, or a State Apprenticeship Agency recognized by the Office, withdraws approval of an apprenticeship program, the contractor will no longer be permitted to utilize apprentices at less than the applicable predetermined rate for the work performed until an acceptable program is approved.

b. Trainees (programs of the USDOL).

Except as provided in 29 CFR 5.16, trainees will not be permitted to work at less than the predetermined rate for the work performed unless they are employed pursuant to and individually registered in a program which has received prior approval, evidenced by formal certification by the U.S. Department of Labor, Employment and Training Administration.

The ratio of trainees to journeymen on the job site shall not be greater than permitted under the plan approved by the Employment and Training Administration.

Every trainee must be paid at not less than the rate specified in the approved program for the trainee's level of progress, expressed as a percentage of the journeyman hourly rate specified in the applicable wage determination. Trainees shall be paid fringe benefits in accordance with the provisions of the trainee program. If the trainee program does not mention fringe benefits, trainees shall be paid the full amount of fringe benefits listed on the wage determination unless the Administrator of the Wage and Hour Division determines that there is an apprenticeship program associated with the corresponding journeyman wage rate on the wage determination which provides for less than full fringe benefits for apprentices. Any employee listed on the payroll at a trainee rate who is not registered and participating in a training plan approved by the Employment and Training Administration shall be paid not less than the applicable wage rate on the wage determination for the classification of work actually performed. In addition, any trainee performing work on the job site in excess of the ratio permitted under the registered program shall be paid not less than the applicable wage rate on the wage determination for the work actually performed.

In the event the Employment and Training Administration withdraws approval of a training program, the contractor will no longer be permitted to utilize trainees at less than the applicable predetermined rate for the work performed until an acceptable program is approved.

c. Equal employment opportunity. The utilization of apprentices, trainees and journeymen under this part shall be in conformity with the equal employment opportunity requirements of Executive Order 11246, as amended, and 29 CFR part 30.

d. Apprentices and Trainees (programs of the U.S. DOT).

Apprentices and trainees working under apprenticeship and skill training programs which have been certified by the Secretary of Transportation as promoting EEO in connection with Federal-aid highway construction programs are not subject to the requirements of paragraph 4 of this Section IV. The straight time hourly wage rates for apprentices and trainees under such programs will be established by the particular programs. The ratio of apprentices and trainees to journeymen shall not be greater than permitted by the terms of the particular program.

5. Compliance with Copeland Act requirements. The contractor shall comply with the requirements of 29 CFR part 3, which are incorporated by reference in this contract.

6. Subcontracts. The contractor or subcontractor shall insert Form FHWA-1273 in any subcontracts and also require the subcontractors to include Form FHWA-1273 in any lower tier subcontracts. The prime contractor shall be responsible for the compliance by any subcontractor or lower tier subcontractor with all the contract clauses in 29 CFR 5.5.

7. Contract termination: debarment. A breach of the contract clauses in 29 CFR 5.5 may be grounds for termination of the contract, and for debarment as a contractor and a subcontractor as provided in 29 CFR 5.12.

8. Compliance with Davis-Bacon and Related Act requirements. All rulings and interpretations of the Davis-Bacon and Related Acts contained in 29 CFR parts 1, 3, and 5 are herein incorporated by reference in this contract.

9. Disputes concerning labor standards. Disputes arising out of the labor standards provisions of this contract shall not be subject to the general disputes clause of this contract. Such disputes shall be resolved in accordance with the procedures of the Department of Labor set forth in 29 CFR parts 5, 6, and 7. Disputes within the meaning of this clause include disputes between the contractor (or any of its subcontractors) and the contracting agency, the U.S. Department of Labor, or the employees or their representatives.

10. Certification of eligibility.

a. By entering into this contract, the contractor certifies that neither it (nor he or she) nor any person or firm who has an interest in the contractor's firm is a person or firm ineligible to be awarded Government contracts by virtue of section 3(a) of the Davis-Bacon Act or 29 CFR 5.12(a)(1).

b. No part of this contract shall be subcontracted to any person or firm ineligible for award of a Government contract by virtue of section 3(a) of the Davis-Bacon Act or 29 CFR 5.12(a)(1).

c. The penalty for making false statements is prescribed in the U.S. Criminal Code, 18 U.S.C. 1001.

V. CONTRACT WORK HOURS AND SAFETY STANDARDS ACT

The following clauses apply to any Federal-aid construction contract in an amount in excess of \$100,000 and subject to the overtime provisions of the Contract Work Hours and Safety Standards Act. These clauses shall be inserted in addition to the clauses required by 29 CFR 5.5(a) or 29 CFR 4.6. As used in this paragraph, the terms laborers and mechanics include watchmen and guards.

1. Overtime requirements. No contractor or subcontractor contracting for any part of the contract work which may require or involve the employment of laborers or mechanics shall require or permit any such laborer or mechanic in any

workweek in which he or she is employed on such work to work in excess of forty hours in such workweek unless such laborer or mechanic receives compensation at a rate not less than one and one-half times the basic rate of pay for all hours worked in excess of forty hours in such workweek.

2. Violation; liability for unpaid wages; liquidated damages. In the event of any violation of the clause set forth in paragraph (1.) of this section, the contractor and any subcontractor responsible therefor shall be liable for the unpaid wages. In addition, such contractor and subcontractor shall be liable to the United States (in the case of work done under contract for the District of Columbia or a territory, to such District or to such territory), for liquidated damages. Such liquidated damages shall be computed with respect to each individual laborer or mechanic, including watchmen and guards, employed in violation of the clause set forth in paragraph (1.) of this section, in the sum of \$10 for each calendar day on which such individual was required or permitted to work in excess of the standard workweek of forty hours without payment of the overtime wages required by the clause set forth in paragraph (1.) of this section.

3. Withholding for unpaid wages and liquidated damages. The FHWA or the contracting agency shall upon its own action or upon written request of an authorized representative of the Department of Labor withhold or cause to be withheld, from any moneys payable on account of work performed by the contractor or subcontractor under any such contract or any other Federal contract with the same prime contractor, or any other federally-assisted contract subject to the Contract Work Hours and Safety Standards Act, which is held by the same prime contractor, such sums as may be determined to be necessary to satisfy any liabilities of such contractor or subcontractor for unpaid wages and liquidated damages as provided in the clause set forth in paragraph (2.) of this section.

4. Subcontracts. The contractor or subcontractor shall insert in any subcontracts the clauses set forth in paragraph (1.) through (4.) of this section and also a clause requiring the subcontractors to include these clauses in any lower tier subcontracts. The prime contractor shall be responsible for compliance by any subcontractor or lower tier subcontractor with the clauses set forth in paragraphs (1.) through (4.) of this section.

VI. SUBLETTING OR ASSIGNING THE CONTRACT

This provision is applicable to all Federal-aid construction contracts on the National Highway System.

1. The contractor shall perform with its own organization contract work amounting to not less than 30 percent (or a greater percentage if specified elsewhere in the contract) of the total original contract price, excluding any specialty items designated by the contracting agency. Specialty items may be performed by subcontract and the amount of any such specialty items performed may be deducted from the total original contract price before computing the amount of work required to be performed by the contractor's own organization (23 CFR 635.116).

a. The term "perform work with its own organization" refers to workers employed or leased by the prime contractor, and equipment owned or rented by the prime contractor, with or without operators. Such term does not include employees or equipment of a

subcontractor or lower tier subcontractor, agents of the prime contractor, or any other assignees. The term may include payments for the costs of hiring leased employees from an employee leasing firm meeting all relevant Federal and State regulatory requirements. Leased employees may only be included in this term if the prime contractor meets all of the following conditions:

- (1) The prime contractor maintains control over the supervision of the day-to-day activities of the leased employees;
- (2) The prime contractor remains responsible for the quality of the work of the leased employees;
- (3) The prime contractor retains all power to accept or exclude individual employees from work on the project; and
- (4) The prime contractor remains ultimately responsible for the payment of predetermined minimum wages, the submission of payrolls, statements of compliance and all other Federal regulatory requirements.

b. "Specialty Items" shall be construed to be limited to work that requires highly specialized knowledge, abilities, or equipment not ordinarily available in the type of contracting organizations qualified and expected to bid or propose on the contract as a whole and in general are to be limited to minor components of the overall contract.

2. The contract amount upon which the requirements set forth in paragraph (1) of Section VI is computed includes the cost of material and manufactured products which are to be purchased or produced by the contractor under the contract provisions.

3. The contractor shall furnish (a) a competent superintendent or supervisor who is employed by the firm, has full authority to direct performance of the work in accordance with the contract requirements, and is in charge of all construction operations (regardless of who performs the work) and (b) such other of its own organizational resources (supervision, management, and engineering services) as the contracting officer determines is necessary to assure the performance of the contract.

4. No portion of the contract shall be sublet, assigned or otherwise disposed of except with the written consent of the contracting officer, or authorized representative, and such consent when given shall not be construed to relieve the contractor of any responsibility for the fulfillment of the contract. Written consent will be given only after the contracting agency has assured that each subcontract is evidenced in writing and that it contains all pertinent provisions and requirements of the prime contract.

5. The 30% self-performance requirement of paragraph (1) is not applicable to design-build contracts; however, contracting agencies may establish their own self-performance requirements.

VII. SAFETY: ACCIDENT PREVENTION

This provision is applicable to all Federal-aid construction contracts and to all related subcontracts.

1. In the performance of this contract the contractor shall comply with all applicable Federal, State, and local laws governing safety, health, and sanitation (23 CFR 635). The contractor shall provide all safeguards, safety devices and protective equipment and take any other needed actions as it determines, or as the contracting officer may determine, to be reasonably necessary to protect the life

and health of employees on the job and the safety of the public and to protect property in connection with the performance of the work covered by the contract.

2. It is a condition of this contract, and shall be made a condition of each subcontract, which the contractor enters into pursuant to this contract, that the contractor and any subcontractor shall not permit any employee, in performance of the contract, to work in surroundings or under conditions which are unsanitary, hazardous or dangerous to his/her health or safety, as determined under construction safety and health standards (29 CFR 1926) promulgated by the Secretary of Labor, in accordance with Section 107 of the Contract Work Hours and Safety Standards Act (40 U.S.C. 3704).

3. Pursuant to 29 CFR 1926.3, it is a condition of this contract that the Secretary of Labor or authorized representative thereof, shall have right of entry to any site of contract performance to inspect or investigate the matter of compliance with the construction safety and health standards and to carry out the duties of the Secretary under Section 107 of the Contract Work Hours and Safety Standards Act (40 U.S.C.3704).

VIII. FALSE STATEMENTS CONCERNING HIGHWAY PROJECTS

This provision is applicable to all Federal-aid construction contracts and to all related subcontracts.

In order to assure high quality and durable construction in conformity with approved plans and specifications and a high degree of reliability on statements and representations made by engineers, contractors, suppliers, and workers on Federal-aid highway projects, it is essential that all persons concerned with the project perform their functions as carefully, thoroughly, and honestly as possible. Willful falsification, distortion, or misrepresentation with respect to any facts related to the project is a violation of Federal law. To prevent any misunderstanding regarding the seriousness of these and similar acts, Form FHWA-1022 shall be posted on each Federal-aid highway project (23 CFR 635) in one or more places where it is readily available to all persons concerned with the project:

18 U.S.C. 1020 reads as follows:

"Whoever, being an officer, agent, or employee of the United States, or of any State or Territory, or whoever, whether a person, association, firm, or corporation, knowingly makes any false statement, false representation, or false report as to the character, quality, quantity, or cost of the material used or to be used, or the quantity or quality of the work performed or to be performed, or the cost thereof in connection with the submission of plans, maps, specifications, contracts, or costs of construction on any highway or related project submitted for approval to the Secretary of Transportation; or

Whoever knowingly makes any false statement, false representation, false report or false claim with respect to the character, quality, quantity, or cost of any work performed or to be performed, or materials furnished or to be furnished, in connection with the construction of any highway or related project approved by the Secretary of Transportation; or

Whoever knowingly makes any false statement or false representation as to material fact in any statement, certificate, or report submitted pursuant to provisions of the Federal-aid Roads

Act approved July 1, 1916, (39 Stat. 355), as amended and supplemented;

Shall be fined under this title or imprisoned not more than 5 years or both."

IX. IMPLEMENTATION OF CLEAN AIR ACT AND FEDERAL WATER POLLUTION CONTROL ACT

This provision is applicable to all Federal-aid construction contracts and to all related subcontracts.

By submission of this bid/proposal or the execution of this contract, or subcontract, as appropriate, the bidder, proposer, Federal-aid construction contractor, or subcontractor, as appropriate, will be deemed to have stipulated as follows:

1. That any person who is or will be utilized in the performance of this contract is not prohibited from receiving an award due to a violation of Section 508 of the Clean Water Act or Section 306 of the Clean Air Act.

2. That the contractor agrees to include or cause to be included the requirements of paragraph (1) of this Section X in every subcontract, and further agrees to take such action as the contracting agency may direct as a means of enforcing such requirements.

X. CERTIFICATION REGARDING DEBARMENT, SUSPENSION, INELIGIBILITY AND VOLUNTARY EXCLUSION

This provision is applicable to all Federal-aid construction contracts, design-build contracts, subcontracts, lower-tier subcontracts, purchase orders, lease agreements, consultant contracts or any other covered transaction requiring FHWA approval or that is estimated to cost \$25,000 or more – as defined in 2 CFR Parts 180 and 1200.

1. Instructions for Certification – First Tier Participants:

a. By signing and submitting this proposal, the prospective first tier participant is providing the certification set out below.

b. The inability of a person to provide the certification set out below will not necessarily result in denial of participation in this covered transaction. The prospective first tier participant shall submit an explanation of why it cannot provide the certification set out below. The certification or explanation will be considered in connection with the department or agency's determination whether to enter into this transaction. However, failure of the prospective first tier participant to furnish a certification or an explanation shall disqualify such a person from participation in this transaction.

c. The certification in this clause is a material representation of fact upon which reliance was placed when the contracting agency determined to enter into this transaction. If it is later determined that the prospective participant knowingly rendered an erroneous certification, in addition to other remedies available to the Federal Government, the contracting agency may terminate this transaction for cause of default.

d. The prospective first tier participant shall provide immediate written notice to the contracting agency to whom this proposal is submitted if any time the prospective first tier participant learns that its certification was erroneous when submitted or has become erroneous by reason of changed circumstances.

e. The terms "covered transaction," "debarred," "suspended," "ineligible," "participant," "person," "principal," and "voluntarily excluded," as used in this clause, are defined in 2 CFR Parts 180 and 1200. "First Tier Covered Transactions" refers to any covered transaction between a grantee or subgrantee of Federal funds and a participant (such as the prime or general contract). "Lower Tier Covered Transactions" refers to any covered transaction under a First Tier Covered Transaction (such as subcontracts). "First Tier Participant" refers to the participant who has entered into a covered transaction with a grantee or subgrantee of Federal funds (such as the prime or general contractor). "Lower Tier Participant" refers to any participant who has entered into a covered transaction with a First Tier Participant or other Lower Tier Participants (such as subcontractors and suppliers).

f. The prospective first tier participant agrees by submitting this proposal that, should the proposed covered transaction be entered into, it shall not knowingly enter into any lower tier covered transaction with a person who is debarred, suspended, declared ineligible, or voluntarily excluded from participation in this covered transaction, unless authorized by the department or agency entering into this transaction.

g. The prospective first tier participant further agrees by submitting this proposal that it will include the clause titled "Certification Regarding Debarment, Suspension, Ineligibility and Voluntary Exclusion-Lower Tier Covered Transactions," provided by the department or contracting agency, entering into this covered transaction, without modification, in all lower tier covered transactions and in all solicitations for lower tier covered transactions exceeding the \$25,000 threshold.

h. A participant in a covered transaction may rely upon a certification of a prospective participant in a lower tier covered transaction that is not debarred, suspended, ineligible, or voluntarily excluded from the covered transaction, unless it knows that the certification is erroneous. A participant is responsible for ensuring that its principals are not suspended, debarred, or otherwise ineligible to participate in covered transactions. To verify the eligibility of its principals, as well as the eligibility of any lower tier prospective participants, each participant may, but is not required to, check the Excluded Parties List System website (<https://www.epls.gov/>), which is compiled by the General Services Administration.

i. Nothing contained in the foregoing shall be construed to require the establishment of a system of records in order to render in good faith the certification required by this clause. The knowledge and information of the prospective participant is not required to exceed that which is normally possessed by a prudent person in the ordinary course of business dealings.

j. Except for transactions authorized under paragraph (f) of these instructions, if a participant in a covered transaction knowingly enters into a lower tier covered transaction with a person who is suspended, debarred, ineligible, or voluntarily excluded from participation in this transaction, in addition to other remedies available to the Federal Government, the department or agency may terminate this transaction for cause of default.

* * * * *

2. Certification Regarding Debarment, Suspension, Ineligibility and Voluntary Exclusion – First Tier Participants:

a. The prospective first tier participant certifies to the best of its knowledge and belief, that it and its principals:

(1) Are not presently debarred, suspended, proposed for debarment, declared ineligible, or voluntarily excluded from participating in covered transactions by any Federal department or agency;

(2) Have not within a three-year period preceding this proposal been convicted of or had a civil judgment rendered against them for commission of fraud or a criminal offense in connection with obtaining, attempting to obtain, or performing a public (Federal, State or local) transaction or contract under a public transaction; violation of Federal or State antitrust statutes or commission of embezzlement, theft, forgery, bribery, falsification or destruction of records, making false statements, or receiving stolen property;

(3) Are not presently indicted for or otherwise criminally or civilly charged by a governmental entity (Federal, State or local) with commission of any of the offenses enumerated in paragraph (a)(2) of this certification; and

(4) Have not within a three-year period preceding this application/proposal had one or more public transactions (Federal, State or local) terminated for cause or default.

b. Where the prospective participant is unable to certify to any of the statements in this certification, such prospective participant shall attach an explanation to this proposal.

2. Instructions for Certification - Lower Tier Participants:

(Applicable to all subcontracts, purchase orders and other lower tier transactions requiring prior FHWA approval or estimated to cost \$25,000 or more - 2 CFR Parts 180 and 1200)

a. By signing and submitting this proposal, the prospective lower tier is providing the certification set out below.

b. The certification in this clause is a material representation of fact upon which reliance was placed when this transaction was entered into. If it is later determined that the prospective lower tier participant knowingly rendered an erroneous certification, in addition to other remedies available to the Federal Government, the department, or agency with which this transaction originated may pursue available remedies, including suspension and/or debarment.

c. The prospective lower tier participant shall provide immediate written notice to the person to which this proposal is submitted if at any time the prospective lower tier participant learns that its certification was erroneous by reason of changed circumstances.

d. The terms "covered transaction," "debarred," "suspended," "ineligible," "participant," "person," "principal," and "voluntarily excluded," as used in this clause, are defined in 2 CFR Parts 180 and 1200. You may contact the person to which this proposal is submitted for assistance in obtaining a copy of those regulations. "First Tier Covered Transactions" refers to any covered transaction

between a grantee or subgrantee of Federal funds and a participant (such as the prime or general contract). "Lower Tier Covered Transactions" refers to any covered transaction under a First Tier Covered Transaction (such as subcontracts). "First Tier Participant" refers to the participant who has entered into a covered transaction with a grantee or subgrantee of Federal funds (such as the prime or general contractor). "Lower Tier Participant" refers to any participant who has entered into a covered transaction with a First Tier Participant or other Lower Tier Participants (such as subcontractors and suppliers).

e. The prospective lower tier participant agrees by submitting this proposal that, should the proposed covered transaction be entered into, it shall not knowingly enter into any lower tier covered transaction with a person who is debarred, suspended, declared ineligible, or voluntarily excluded from participation in this covered transaction, unless authorized by the department or agency with which this transaction originated.

f. The prospective lower tier participant further agrees by submitting this proposal that it will include this clause titled "Certification Regarding Debarment, Suspension, Ineligibility and Voluntary Exclusion-Lower Tier Covered Transaction," without modification, in all lower tier covered transactions and in all solicitations for lower tier covered transactions exceeding the \$25,000 threshold.

g. A participant in a covered transaction may rely upon a certification of a prospective participant in a lower tier covered transaction that is not debarred, suspended, ineligible, or voluntarily excluded from the covered transaction, unless it knows that the certification is erroneous. A participant is responsible for ensuring that its principals are not suspended, debarred, or otherwise ineligible to participate in covered transactions. To verify the eligibility of its principals, as well as the eligibility of any lower tier prospective participants, each participant may, but is not required to, check the Excluded Parties List System website (<https://www.epls.gov/>), which is compiled by the General Services Administration.

h. Nothing contained in the foregoing shall be construed to require establishment of a system of records in order to render in good faith the certification required by this clause. The knowledge and information of participant is not required to exceed that which is normally possessed by a prudent person in the ordinary course of business dealings.

i. Except for transactions authorized under paragraph e of these instructions, if a participant in a covered transaction knowingly enters into a lower tier covered transaction with a person who is suspended, debarred, ineligible, or voluntarily excluded from participation in this transaction, in addition to other remedies available to the Federal Government, the 11 department or agency with which this transaction originated may pursue available remedies, including suspension and/or debarment.

* * * * *

Certification Regarding Debarment, Suspension, Ineligibility and Voluntary Exclusion--Lower Tier Participants:

1. The prospective lower tier participant certifies, by submission of this proposal, that neither it nor its principals is presently debarred, suspended, proposed for debarment, declared ineligible, or

voluntarily excluded from participating in covered transactions by any Federal department or agency.

2. Where the prospective lower tier participant is unable to certify to any of the statements in this certification, such prospective participant shall attach an explanation to this proposal.

* * * * *

XI. CERTIFICATION REGARDING USE OF CONTRACT FUNDS FOR LOBBYING

This provision is applicable to all Federal-aid construction contracts and to all related subcontracts which exceed \$100,000 (49 CFR 20).

1. The prospective participant certifies, by signing and submitting this bid or proposal, to the best of his or her knowledge and belief, that:

a. No Federal appropriated funds have been paid or will be paid, by or on behalf of the undersigned, to any person for influencing or attempting to influence an officer or employee of any Federal agency, a Member of Congress, an officer or employee of Congress, or an employee of a Member of Congress in connection with the awarding of any Federal contract, the making of any Federal grant, the making of any Federal loan, the entering into of any cooperative agreement, and the extension, continuation, renewal, amendment, or modification of any Federal contract, grant, loan, or cooperative agreement.

b. If any funds other than Federal appropriated funds have been paid or will be paid to any person for influencing or attempting to influence an officer or employee of any Federal agency, a Member of Congress, an officer or employee of Congress, or an employee of a Member of Congress in connection with this Federal contract, grant, loan, or cooperative agreement, the undersigned shall complete and submit Standard Form-LLL, "Disclosure Form to Report Lobbying," in accordance with its instructions.

2. This certification is a material representation of fact upon which reliance was placed when this transaction was made or entered into. Submission of this certification is a prerequisite for making or entering into this transaction imposed by 31 U.S.C. 1352. Any person who fails to file the required certification shall be subject to a civil penalty of not less than \$10,000 and not more than \$100,000 for each such failure.

3. The prospective participant also agrees by submitting its bid or proposal that the participant shall require that the language of this certification be included in all lower tier subcontracts, which exceed \$100,000 and that all such recipients shall certify and disclose accordingly.

**Replace section 7-1.11C with:
FEMALE AND MINORITY GOALS (Required Federal Language)**

To comply with Section II, "Nondiscrimination," of "Required Contract Provisions Federal-Aid Construction Contracts," the following female and minority utilization goals for Federal-aid construction contracts and subcontracts that exceed \$10,000.

The nationwide goal for female utilization is 6.9 percent.

The goals for minority utilization [45 Fed Reg 65984 (10/3/1980)] are as follows:

MINORITY UTILIZATION GOALS

	Economic Area	Goal (Percent)
174	Redding CA: Non-SMSA Counties: CA Lassen; CA Modoc; CA Plumas; CA Shasta; CA Siskiyou; CA Tehama	6.8
175	Eureka, CA Non-SMSA Counties: CA Del Norte; CA Humboldt; CA Trinity	6.6
176	San Francisco-Oakland-San Jose, CA: SMSA Counties: 7120 Salinas-Seaside-Monterey, CA CA Monterey 7360 San Francisco-Oakland CA Alameda; CA Contra Costa; CA Marin; CA San Francisco; CA San Mateo 7400 San Jose, CA CA Santa Clara, CA 7485 Santa Cruz, CA CA Santa Cruz 7500 Santa Rosa CA Sonoma 8720 Vallejo-Fairfield-Napa, CA CA Napa; CA Solano Non-SMSA Counties: CA Lake; CA Mendocino; CA San Benito	28.9 25.6 19.6 14.9 9.1 17.1 23.2
177	Sacramento, CA: SMSA Counties: 6920 Sacramento, CA CA Placer; CA Sacramento; CA Yolo Non-SMSA Counties CA Butte; CA Colusa; CA El Dorado; CA Glenn; CA Nevada; CA Sierra; CA Sutter; CA Yuba	16.1 14.3
178	Stockton-Modesto, CA: SMSA Counties: 5170 Modesto, CA CA Stanislaus 8120 Stockton, CA CA San Joaquin Non-SMSA Counties CA Alpine; CA Amador; CA Calaveras; CA Mariposa; CA Merced; CA Toulumne	12.3 24.3 19.8
179	Fresno-Bakersfield, CA SMSA Counties: 0680 Bakersfield, CA CA Kern 2840 Fresno, CA	19.1 26.1

	CA Fresno Non-SMSA Counties: CA Kings; CA Madera; CA Tulare	23.6
180	Los Angeles, CA: SMSA Counties: 0360 Anaheim-Santa Ana-Garden Grove, CA CA Orange 4480 Los Angeles-Long Beach, CA CA Los Angeles 6000 Oxnard-Simi Valley-Ventura, CA CA Ventura 6780 Riverside-San Bernardino-Ontario, CA CA Riverside; CA San Bernardino 7480 Santa Barbara-Santa Maria-Lompoc, CA CA Santa Barbara Non-SMSA Counties CA Inyo; CA Mono; CA San Luis Obispo	11.9 28.3 21.5 19.0 19.7 24.6
181	San Diego, CA: SMSA Counties 7320 San Diego, CA CA San Diego Non-SMSA Counties CA Imperial	16.9 18.2

For the last full week of July during which work is performed under the contract, the prime contractor and each non material-supplier subcontractor with a subcontract of \$10,000 or more must complete Form FHWA PR-1391 (Appendix C to 23 CFR 230). Submit the forms by August 15.

Replace section 7-1.11D Training with:
FEDERAL TRAINEE PROGRAM (Required Federal Language)

For the Federal training program, the number of trainees or apprentices is **0 (Number)**.

This section applies if a number of trainees or apprentices is specified in the special provisions.

As part of the prime contractor's equal opportunity affirmative action program, provide on-the-job training to develop full journeymen in the types of trades or job classifications involved.

The prime contractor has primary responsibility for meeting this training requirement.

If the prime contractor subcontracts a contract part, they shall determine how many trainees or apprentices are to be trained by the subcontractor. Include these training requirements in each subcontract.

Where feasible, 25 percent of apprentices or trainees in each occupation must be in their 1st year of apprenticeship or training.

Distribute the number of apprentices or trainees among the work classifications on the basis of the prime contractor's needs and the availability of journeymen in the various classifications within a reasonable recruitment area.

Before starting work, the prime contractor shall submit to the County of Humboldt:

1. Number of apprentices or trainees to be trained for each classification

2. Training program to be used
3. Training starting date for each classification

The prime contractor shall obtain the County of Humboldt approval for this submitted information before the prime contractor starts work. The County of Humboldt credits the prime contractor for each apprentice or trainee the prime contractor employs on the job who is currently enrolled or becomes enrolled in an approved program.

The primary objective of this section is to train and upgrade minorities and women toward journeyman status. The prime contractor shall make every effort to enroll minority and women apprentices or trainees, such as conducting systematic and direct recruitment through public and private sources likely to yield minority and women apprentices or trainees, to the extent they are available within a reasonable recruitment area and show that they have made the efforts. In making these efforts, the prime contractor shall not discriminate against any applicant for training.

The prime contractor shall not employ as an apprentice or trainee an employee:

1. In any classification in which the employee has successfully completed a training course leading to journeyman status or in which the employee has been employed as a journeyman
2. Who is not registered in a program approved by the US Department of Labor, Bureau of Apprenticeship and Training

The prime contractor shall ask the employee if the employee has successfully completed a training course leading to journeyman status or has been employed as a journeyman. The prime contractor's records must show the employee's answers to the questions.

In the training program, the prime contractor shall establish the minimum length and training type for each classification. The County of Humboldt and FHWA approves a program if one of the following is met:

1. It is calculated to:
 - Meet the your equal employment opportunity responsibilities
 - Qualify the average apprentice or trainee for journeyman status in the classification involved by the end of the training period
2. It is registered with the U.S. Department of Labor, Bureau of Apprenticeship and Training, and it is administered in a way consistent with the equal employment responsibilities of Federal-aid highway construction contracts

The prime contractor shall obtain the State's approval for their training program before they start work involving the classification covered by the program.

The prime contractor shall provide training in the construction crafts, not in clerk-typist or secretarial-type positions. Training is allowed in lower level management positions such as office engineers, estimators, and timekeepers if the training is oriented toward construction applications. Training is allowed in the

"General Decision Number: CA20210004 07/02/2021

Superseded General Decision Number: CA20200004

State: California

Construction Types: Heavy (Heavy and Dredging) and Highway

Counties: Del Norte, Humboldt, Lake and Mendocino Counties in California.

DREDGING PROJECTS (does not include hopper dredge work); HEAVY CONSTRUCTION PROJECTS (does not include water well drilling); AND HIGHWAY CONSTRUCTION PROJECTS

Note: Under Executive Order (EO) 13658, an hourly minimum wage of \$10.95 for calendar year 2021 applies to all contracts subject to the Davis-Bacon Act for which the contract is awarded (and any solicitation was issued) on or after January 1, 2015. If this contract is covered by the EO, the contractor must pay all workers in any classification listed on this wage determination at least \$10.95 per hour (or the applicable wage rate listed on this wage determination, if it is higher) for all hours spent performing on the contract in calendar year 2021. If this contract is covered by the EO and a classification considered necessary for performance of work on the contract does not appear on this wage determination, the contractor must pay workers in that classification at least the wage rate determined through the conformance process set forth in 29 CFR 5.5(a)(1)(ii) (or the EO minimum wage rate, if it is higher than the conformed wage rate). The EO minimum wage rate will be adjusted annually. Please note that this EO applies to the above-mentioned types of contracts entered into by the federal government that are subject to the Davis-Bacon Act itself, but it does not apply to contracts subject only to the Davis-Bacon Related Acts, including those set forth at 29 CFR 5.1(a)(2)-(60). Additional information on contractor requirements and worker protections under the EO is available at www.dol.gov/whd/govcontracts.

Modification Number	Publication Date
0	01/01/2021
1	02/26/2021
2	04/02/2021
3	04/23/2021
4	06/25/2021
5	07/02/2021

ASBE0016-005 01/01/2021

Rates Fringes

Asbestos Workers/Insulator (Includes the application of all insulating materials, Protective Coverings, Coatings, and Finishes to all types of mechanical systems)		
(1) Mendocino County.....	\$ 46.81	33.50
(2) Del Norte, Humboldt, Lake Counties.....	\$ 46.81	33.50

ASBE0016-006 01/01/2021

Rates Fringes

Asbestos Removal worker/hazardous material handler (Includes preparation, wetting, stripping, removal, scrapping, vacuuming, bagging and disposing of all insulation materials from mechanical systems, whether they contain asbestos or not)....	\$ 30.45	10.60
------------------------------------------------------------------------------------------------------------------------------------------------------------------------------------------------------------------------------------------------------------------------------	----------	-------

BRCA0003-001 08/01/2020

Rates Fringes

MARBLE FINISHER.....	\$ 36.53	17.08
----------------------	----------	-------

BRCA0003-003 08/01/2020

	Rates	Fringes
MARBLE MASON.....	\$ 51.30	28.47

BRCA003-006 05/01/2020

	Rates	Fringes
BRICKLAYER.....	\$ 47.65	27.47

SPECIALTY PAY:

- (A) Underground work such as tunnel work, sewer work, manholes, catch basins, sewer pipes and telephone conduit shall be paid \$1.25 per hour above the regular rate. Work in direct contact with raw sewage shall receive \$1.25 per hour in addition to the above.
- (B) Operating a saw or grinder shall receive \$1.25 per hour above the regular rate.
- (C) Guniting nozzle person shall receive \$1.25 per hour above the regular rate.

BRCA003-008 07/01/2019

	Rates	Fringes
TERRAZZO FINISHER.....	\$ 37.58	17.33
TERRAZZO WORKER/SETTER.....	\$ 48.53	26.84

BRCA003-013 04/01/2020

	Rates	Fringes
TILE FINISHER		
Del Norte & Humboldt		
Counties.....	\$ 31.22	17.10
Lake & Mendocino Counties...	\$ 29.34	16.54
TILE LAYER		
Del Norte & Humboldt		
Counties.....	\$ 52.03	20.31
Lake & Mendocino Counties...	\$ 48.90	20.23

* CARP0034-001 07/01/2021

	Rates	Fringes
Diver		
Assistant Tender, ROV		
Tender/Technician.....	\$ 54.10	34.69
Diver standby.....	\$ 60.51	34.69
Diver Tender.....	\$ 59.51	34.69
Diver wet.....	\$ 103.62	34.69
Manifold Operator (mixed		
gas).....	\$ 64.51	34.69
Manifold Operator (Standby).	\$ 59.51	34.69

DEPTH PAY (Surface Diving):

050 to 100 ft	\$2.00 per foot
101 to 150 ft	\$3.00 per foot
151 to 220 ft	\$4.00 per foot
221 ft.-deeper	\$5.00 per foot

SATURATION DIVING:

The standby rate shall apply until saturation starts. The saturation diving rate applies when divers are under pressure continuously until work task and decompression are complete. The diver rate shall be paid for all saturation hours.

DIVING IN ENCLOSURES:

Where it is necessary for Divers to enter pipes or tunnels, or other enclosures where there is no vertical ascent, the following premium shall be paid: Distance traveled from entrance 26 feet to 300 feet: \$1.00 per foot. When it is necessary for a diver to enter any pipe, tunnel or other enclosure less than 48" in height, the premium will be \$1.00 per foot.

WORK IN COMBINATION OF CLASSIFICATIONS:

Employees working in any combination of classifications within the diving crew (except dive supervisor) in a shift are paid in the classification with the highest rate for that shift.

* CARP0034-003 07/01/2021

	Rates	Fringes
Piledriver.....	\$ 54.10	34.69

CARP0751-002 07/01/2020

Del Norte, Humboldt, Lake and Mendocino Counties

	Rates	Fringes
Carpenters		
Bridge Builder/Highway Carpenter.....	\$ 52.65	30.82
Hardwood Floorlayer, Shingler, Power Saw Operator, Steel Scaffold & Steel Shoring Erector, Saw Filer.....	\$ 45.57	30.82
Journeyman Carpenter.....	\$ 45.42	30.82
Millwright.....	\$ 47.92	32.41

ELEC0551-001 06/01/2021

LAKE AND MENDOCINO COUNTIES

	Rates	Fringes
ELECTRICIAN.....	\$ 53.90	26.47

TUNNEL WORK: Add \$0.50 per hour.

ELEC0551-002 06/01/2021

DEL NORTE AND HUMBOLDT COUNTIES

	Rates	Fringes
Electricians:.....	\$ 53.90	26.47

TUNNEL WORK: Add \$0.50 per hour.

ELEC1245-002 06/01/2021

HUMBOLDT, LAKE AND MENDOCINO COUNTIES

	Rates	Fringes
LINE CONSTRUCTION		
(1) Lineman; Cable splicer..	\$ 60.19	21.94
(2) Equipment specialist (operates crawler tractors, commercial motor vehicles, backhoes, trenchers, cranes (50 tons and below), overhead & underground distribution line equipment).....	\$ 48.08	20.73
(3) Groundman.....	\$ 36.76	20.33
(4) Powderman.....	\$ 51.87	18.79

HOLIDAYS: New Year's Day, M.L. King Day, Memorial Day,
Independence Day, Labor Day, Veterans Day, Thanksgiving Day
and day after Thanksgiving, Christmas Day

ENGI0003-014 06/29/2020

""AREA 1"" WAGE RATES ARE LISTED BELOW

""AREA 2"" RECEIVES AN ADDITIONAL \$2.00 PER HOUR ABOVE AREA 1
RATES.

SEE AREA DEFINITIONS BELOW

	Rates	Fringes
OPERATOR: Power Equipment (AREA 1:)		
GROUP 1.....	\$ 51.42	31.15
GROUP 2.....	\$ 49.89	31.15
GROUP 3.....	\$ 48.41	31.15
GROUP 4.....	\$ 47.03	31.15
GROUP 5.....	\$ 45.76	31.15
GROUP 6.....	\$ 44.44	31.15
GROUP 7.....	\$ 43.30	31.15
GROUP 8.....	\$ 42.16	31.15
GROUP 8-A.....	\$ 39.95	31.15

OPERATOR: Power Equipment
(Cranes and Attachments -
AREA 1:)

GROUP 1		
Cranes.....	\$ 52.30	31.15
Oiler.....	\$ 43.79	31.15
Truck crane oiler.....	\$ 46.08	31.15
GROUP 2		
Cranes.....	\$ 50.54	31.15
Oiler.....	\$ 42.83	31.15
Truck crane oiler.....	\$ 45.07	31.15
GROUP 3		
Cranes.....	\$ 48.80	31.15
Hydraulic.....	\$ 44.44	31.15
Oiler.....	\$ 42.55	31.15
Truck crane oiler.....	\$ 44.83	31.15
GROUP 4		
Cranes.....	\$ 45.76	31.15

OPERATOR: Power Equipment
(Piledriving - AREA 1:)

GROUP 1		
Lifting devices.....	\$ 52.64	31.15
Oiler.....	\$ 43.38	31.15
Truck Crane Oiler.....	\$ 45.66	31.15
GROUP 2		
Lifting devices.....	\$ 50.82	31.15
Oiler.....	\$ 43.11	31.15
Truck Crane Oiler.....	\$ 45.41	31.15
GROUP 3		
Lifting devices.....	\$ 49.14	31.15
Oiler.....	\$ 42.89	31.15
Truck Crane Oiler.....	\$ 45.12	31.15
GROUP 4		
Lifting devices.....	\$ 47.37	31.15
GROUP 5		
Lifting devices.....	\$ 44.73	31.15
GROUP 6		
Lifting devices.....	\$ 42.50	31.15

OPERATOR: Power Equipment
(Steel Erection - AREA 1:)

GROUP 1		
Cranes.....	\$ 53.27	31.15
Oiler.....	\$ 43.72	31.15
Truck Crane Oiler.....	\$ 45.95	31.15
GROUP 2		
Cranes.....	\$ 51.50	31.15
Oiler.....	\$ 43.45	31.15
Truck Crane Oiler.....	\$ 45.73	31.15
GROUP 3		
Cranes.....	\$ 50.02	31.15
Hydraulic.....	\$ 45.07	31.15
Oiler.....	\$ 43.23	31.15
Truck Crane Oiler.....	\$ 45.46	31.15
GROUP 4		
Cranes.....	\$ 48.00	31.15
GROUP 5		
Cranes.....	\$ 46.70	31.15

OPERATOR: Power Equipment
(Tunnel and Underground Work
- AREA 1:)

SHAFTS, STOPES, RAISES:		
GROUP 1.....	\$ 47.52	31.15
GROUP 1-A.....	\$ 49.99	31.15
GROUP 2.....	\$ 46.26	31.15
GROUP 3.....	\$ 44.93	31.15
GROUP 4.....	\$ 43.79	31.15
GROUP 5.....	\$ 42.65	31.15
UNDERGROUND:		
GROUP 1.....	\$ 47.42	31.15
GROUP 1-A.....	\$ 49.89	31.15
GROUP 2.....	\$ 46.16	31.15
GROUP 3.....	\$ 44.83	31.15
GROUP 4.....	\$ 43.69	31.15
GROUP 5.....	\$ 42.55	31.15

FOOTNOTE: Work suspended by ropes or cables, or work on a Yo-Yo Cat: \$.60 per hour additional.

POWER EQUIPMENT OPERATOR CLASSIFICATIONS

GROUP 1: Operator of helicopter (when used in erection work); Hydraulic excavator, 7 cu. yds. and over; Power shovels, over 7 cu. yds.

GROUP 2: Highline cableway; Hydraulic excavator, 3-1/2 cu. yds. up to 7 cu. yds.; Licensed construction work boat operator, on site; Power blade operator (finish); Power

shovels, over 1 cu. yd. up to and including 7 cu. yds.
m.r.c.

GROUP 3: Asphalt milling machine; Cable backhoe; Combination backhoe and loader over 3/4 cu. yds.; Continuous flight tie back machine assistant to engineer or mechanic; Crane mounted continuous flight tie back machine, tonnage to apply; Crane mounted drill attachment, tonnage to apply; Dozer, slope brd; Gradall; Hydraulic excavator, up to 3 1/2 cu. yds.; Loader 4 cu. yds. and over; Long reach excavator; Multiple engine scraper (when used as push pull); Power shovels, up to and including 1 cu. yd.; Pre-stress wire wrapping machine; Side boom cat, 572 or larger; Track loader 4 cu. yds. and over; Wheel excavator (up to and including 750 cu. yds. per hour)

GROUP 4: Asphalt plant engineer/box person; Chicago boom; Combination backhoe and loader up to and including 3/4 cu. yd.; Concrete batch plant (wet or dry); Dozer and/or push cat; Pull- type elevating loader; Gradesetter, grade checker (GPS, mechanical or otherwise); Grooving and grinding machine; Heading shield operator; Heavy-duty drilling equipment, Hughes, LDH, Watson 3000 or similar; Heavy-duty repairperson and/or welder; Lime spreader; Loader under 4 cu. yds.; Lubrication and service engineer (mobile and grease rack); Mechanical finishers or spreader machine (asphalt, Barber-Greene and similar); Miller Formless M-9000 slope paver or similar; Portable crushing and screening plants; Power blade support; Roller operator, asphalt; Rubber-tired scraper, self-loading (paddle-wheels, etc.); Rubber- tired earthmoving equipment (scrapers); Slip form paver (concrete); Small tractor with drag; Soil stabilizer (P & H or equal); Spider plow and spider puller; Tubex pile rig; Unlicensed construction work boat operator, on site; Timber skidder; Track loader up to 4 yds.; Tractor-drawn scraper; Tractor, compressor drill combination; Welder; Woods-Mixer (and other similar Pugmill equipment)

GROUP 5: Cast-in-place pipe laying machine; Combination slusher and motor operator; Concrete conveyor or concrete pump, truck or equipment mounted; Concrete conveyor, building site; Concrete pump or pumpcrete gun; Drilling equipment, Watson 2000, Texoma 700 or similar; Drilling and boring machinery, horizontal (not to apply to waterliners, wagon drills or jackhammers); Concrete mixer/all; Person and/or material hoist; Mechanical finishers (concrete) (Clary, Johnson, Bidwell Bridge Deck or similar types); Mechanical burm, curb and/or curb and gutter machine, concrete or asphalt; Mine or shaft hoist; Portable crusher; Power jumbo operator (setting slip-forms, etc., in tunnels); Screed (automatic or manual); Self-propelled compactor with dozer; Tractor with boom D6 or smaller; Trenching machine, maximum digging capacity over 5 ft. depth; Vermeer T-600B rock cutter or similar

GROUP 6: Armor-Coater (or similar); Ballast jack tamper; Boom- type backfilling machine; Assistant plant engineer; Bridge and/or gantry crane; Chemical grouting machine, truck-mounted; Chip spreading machine operator; Concrete saw (self-propelled unit on streets, highways, airports and canals); Deck engineer; Drilling equipment Texoma 600, Hughes 200 Series or similar up to and including 30 ft. m.r.c.; Drill doctor; Helicopter radio operator; Hydro-hammer or similar; Line master; Skidsteer loader, Bobcat larger than 743 series or similar (with attachments); Locomotive; Lull hi-lift or similar; Oiler, truck mounted equipment; Pavement breaker, truck-mounted, with compressor combination; Paving fabric installation and/or laying machine; Pipe bending machine (pipelines only); Pipe wrapping machine (tractor propelled and supported); Screed (except asphaltic concrete paving); Self- propelled pipeline wrapping machine; Tractor; Self-loading chipper; Concrete barrier moving machine

GROUP 7: Ballast regulator; Boom truck or dual-purpose A-frame truck, non-rotating - under 15 tons; Cary lift or similar; Combination slurry mixer and/or cleaner; Drilling equipment, 20 ft. and under m.r.c.; Firetender (hot plant); Grouting machine operator; Highline cableway signalperson; Stationary belt loader (Kolman or similar); Lift slab machine (Vagtborg and similar types); Maginnes internal full slab vibrator; Material hoist (1 drum); Mechanical trench shield; Pavement breaker with or without compressor combination; Pipe cleaning machine (tractor propelled and supported); Post driver; Roller (except asphalt); Chip Seal; Self-propelled automatically applied concrete curing machine (on streets, highways, airports and canals);

Self-propelled compactor (without dozer); Signalperson; Slip-form pumps (lifting device for concrete forms); Tie spacer; Tower mobile; Trenching machine, maximum digging capacity up to and including 5 ft. depth; Truck- type loader

GROUP 8: Bit sharpener; Boiler tender; Box operator; Brakeperson; Combination mixer and compressor (shotcrete/gunite); Compressor operator; Deckhand; Fire tender; Forklift (under 20 ft.); Generator; Gunite/shotcrete equipment operator; Hydraulic monitor; Ken seal machine (or similar); Mixermobile; Oiler; Pump operator; Refrigeration plant; Reservoir-debris tug (self-propelled floating); Ross Carrier (construction site); Rotomist operator; Self-propelled tape machine; Shuttlecar; Self-propelled power sweeper operator (includes vacuum sweeper); Slusher operator; Surface heater; Switchperson; Tar pot firetender; Tugger hoist, single drum; Vacuum cooling plant; Welding machine (powered other than by electricity)

GROUP 8-A: Elevator operator; Skidsteer loader-Bobcat 743 series or smaller, and similar (without attachments); Mini excavator under 25 H.P. (backhoe-trencher); Tub grinder wood chipper

ALL CRANES AND ATTACHMENTS

GROUP 1: Clamshell and dragline over 7 cu. yds.; Crane, over 100 tons; Derrick, over 100 tons; Derrick barge pedestal-mounted, over 100 tons; Self-propelled boom-type lifting device, over 100 tons

GROUP 2: Clamshell and dragline over 1 cu. yd. up to and including 7 cu. yds.; Crane, over 45 tons up to and including 100 tons; Derrick barge, 100 tons and under; Self-propelled boom-type lifting device, over 45 tons; Tower crane

GROUP 3: Clamshell and dragline up to and including 1 cu. yd.; Cranes 45 tons and under; Self-propelled boom-type lifting device 45 tons and under;

GROUP 4: Boom Truck or dual purpose A-frame truck, non-rotating over 15 tons; Truck-mounted rotating telescopic boom type lifting device, Manitex or similar (boom truck) over 15 tons; Truck-mounted rotating telescopic boom type lifting device, Manitex or similar (boom truck) - under 15 tons;

PILEDRIVERS

GROUP 1: Derrick barge pedestal mounted over 100 tons; Clamshell over 7 cu. yds.; Self-propelled boom-type lifting device over 100 tons; Truck crane or crawler, land or barge mounted over 100 tons

GROUP 2: Derrick barge pedestal mounted 45 tons to and including 100 tons; Clamshell up to and including 7 cu. yds.; Self-propelled boom-type lifting device over 45 tons; Truck crane or crawler, land or barge mounted, over 45 tons up to and including 100 tons; Fundex F-12 hydraulic pile rig

GROUP 3: Derrick barge pedestal mounted under 45 tons; Self-propelled boom-type lifting device 45 tons and under; Skid/scow piledriver, any tonnage; Truck crane or crawler, land or barge mounted 45 tons and under

GROUP 4: Assistant operator in lieu of assistant to engineer; Forklift, 10 tons and over; Heavy-duty repairperson/welder

GROUP 5: Deck engineer

GROUP 6: Deckhand; Fire tender

STEEL ERECTORS

GROUP 1: Crane over 100 tons; Derrick over 100 tons; Self-propelled boom-type lifting device over 100 tons

GROUP 2: Crane over 45 tons to 100 tons; Derrick under 100 tons; Self-propelled boom-type lifting device over 45 tons to 100 tons; Tower crane

GROUP 3: Crane, 45 tons and under; Self-propelled boom-type lifting device, 45 tons and under

GROUP 4: Chicago boom; Forklift, 10 tons and over; Heavy-duty repair person/welder

GROUP 5: Boom cat

--

TUNNEL AND UNDERGROUND WORK

GROUP 1-A: Tunnel bore machine operator, 20' diameter or more

GROUP 1: Heading shield operator; Heavy-duty repairperson; Mucking machine (rubber tired, rail or track type); Raised bore operator (tunnels); Tunnel mole bore operator

GROUP 2: Combination slusher and motor operator; Concrete pump or pumpcrete gun; Power jumbo operator

GROUP 3: Drill doctor; Mine or shaft hoist

GROUP 4: Combination slurry mixer cleaner; Grouting Machine operator; Motorman

GROUP 5: Bit Sharpener; Brakeman; Combination mixer and compressor (gunite); Compressor operator; Oiler; Pump operator; Slusher operator

AREA DESCRIPTIONS:

POWER EQUIPMENT OPERATORS, CRANES AND ATTACHMENTS, TUNNEL AND UNDERGROUND [These areas do not apply to Piledrivers and Steel Erectors]

AREA 1: DEL NORTE, HUMBOLDT, LAKE, MENDOCINO
AREA 2 -NOTED BELOW

THE REMAINING COUNTIES ARE SPLIT BETWEEN AREA 1 AND AREA 2 AS NOTED BELOW:

DEL NORTE COUNTY:

Area 1: Extreme Southwest corner
Area 2: Remainder

HUMBOLDT COUNTY:

Area 1: Except Eastern and Southwestern parts
Area 2: Remainder

LAKE COUNTY:

Area 1: Southern part
Area 2: Remainder

MENDOCINO COUNTY:

Area 1: Central and Southeastern Parts
Area 2: Remainder

ENGI003-019 06/29/2020

SEE AREA DESCRIPTIONS BELOW

	Rates	Fringes
OPERATOR: Power Equipment (LANDSCAPE WORK ONLY)		
GROUP 1		
AREA 1.....	\$ 39.95	30.28
AREA 2.....	\$ 41.95	30.28
GROUP 2		
AREA 1.....	\$ 36.35	30.28
AREA 2.....	\$ 38.35	30.28
GROUP 3		
AREA 1.....	\$ 31.74	30.28
AREA 2.....	\$ 33.74	30.28

GROUP DESCRIPTIONS:

GROUP 1: Landscape Finish Grade Operator: All finish grade work regardless of equipment used, and all equipment with a rating more than 65 HP.

GROUP 2: Landscape Operator up to 65 HP: All equipment with

a manufacturer's rating of 65 HP or less except equipment covered by Group 1 or Group 3. The following equipment shall be included except when used for finish work as long as manufacturer's rating is 65 HP or less: A-Frame and Winch Truck, Backhoe, Forklift, Hydragraphic Seeder Machine, Roller, Rubber-Tired and Track Earthmoving Equipment, Skiploader, Straw Blowers, and Trencher 31 HP up to 65 HP.

GROUP 3: Landsca Utility Operator: Small Rubber-Tired Tractor, Trencher Under 31 HP.

AREA DESCRIPTIONS:

AREA 1: ALAMEDA, BUTTE, CONTRA COSTA, KINGS, MARIN, MERCED, NAPA, SACRAMENTO, SAN BENITO, SAN FRANCISCO, SAN JOAQUIN, SAN MATEO, SANTA CLARA, SANTA CRUZ, SOLANO, STANISLAUS, SUTTER, YOLO, AND YUBA COUNTIES

AREA 2 - MODOC COUNTY

THE REMAINING COUNTIES ARE SPLIT BETWEEN AREA 1 AND AREA 2 AS NOTED BELOW:

ALPINE COUNTY:

Area 1: Northernmost part
Area 2: Remainder

CALAVERAS COUNTY:

Area 1: Except Eastern part
Area 2: Eastern part

COLUSA COUNTY:

Area 1: Eastern part
Area 2: Remainder

DEL NORTE COUNTY:

Area 1: Extreme Southwestern corner
Area 2: Remainder

ELDORADO COUNTY:

Area 1: North Central part
Area 2: Remainder

FRESNO COUNTY

Area 1: Except Eastern part
Area 2: Eastern part

GLENN COUNTY:

Area 1: Eastern part
Area 2: Remainder

HUMBOLDT COUNTY:

Area 1: Except Eastern and Southwestern parts
Area 2: Remainder

LAKE COUNTY:

Area 1: Southern part
Area 2: Remainder

LASSEN COUNTY:

Area 1: Western part along the Southern portion of border with Shasta County
Area 2: Remainder

MADERA COUNTY

Area 1: Remainder
Area 2: Eastern part

MARIPOSA COUNTY

Area 1: Remainder
Area 2: Eastern part

MENDOCINO COUNTY:

Area 1: Central and Southeastern parts
Area 2: Remainder

MONTEREY COUNTY

Area 1: Remainder
Area 2: Southwestern part

NEVADA COUNTY:

Area 1: All but the Northern portion along the border of Sierra County
Area 2: Remainder

PLACER COUNTY:

Area 1: All but the Central portion

Area 2: Remainder

PLUMAS COUNTY:

Area 1: Western portion
Area 2: Remainder

SHASTA COUNTY:

Area 1: All but the Northeastern corner
Area 2: Remainder

SIERRA COUNTY:

Area 1: Western part
Area 2: Remainder

SISKIYOU COUNTY:

Area 1: Central part
Area 2: Remainder

SONOMA COUNTY:

Area 1: All but the Northwestern corner
Area 2: Reaminder

TEHAMA COUNTY:

Area 1: All but the Western border with mendocino & Trinity
Counties
Area 2: Remainder

TRINITY COUNTY:

Area 1: East Central part and the Northeaster border with
Shasta County
Area 2: Remainder

TULARE COUNTY;

Area 1: Remainder
Area 2: Eastern part

TUOLUMNE COUNTY:

Area 1: Remainder
Area 2: Eastern Part

IRON0433-006 07/01/2020

	Rates	Fringes
IRONWORKER		
Fence Erector.....	\$ 34.58	24.81
Ornamental, Reinforcing and Structural.....	\$ 41.00	33.45

PREMIUM PAY:

\$6.00 additional per hour at the following locations:

China Lake Naval Test Station, Chocolate Mountains Naval Reserve-Niland, Edwards AFB, Fort Irwin Military Station, Fort Irwin Training Center-Goldstone, San Clemente Island, San Nicholas Island, Susanville Federal Prison, 29 Palms - Marine Corps, U.S. Marine Base - Barstow, U.S. Naval Air Facility - Sealey, Vandenberg AFB

\$4.00 additional per hour at the following locations:

Army Defense Language Institute - Monterey, Fallon Air Base, Naval Post Graduate School - Monterey, Yermo Marine Corps Logistics Center

\$2.00 additional per hour at the following locations:

Port Hueneme, Port Mugu, U.S. Coast Guard Station - Two Rock

* LAB0067-002 06/28/2021

AREA ""A"" - ALAMEDA, CONTRA COSTA, SAN FRANCISCO, SAN MATEO AND SANTA CLARA COUNTIES

AREA ""B"" - CALAVERAS, FRESNO, KINGS, MADERA, MARIPOSA, MERCED, MONTEREY, SAN BENITO, SAN JOAQUIN, STANISLAUS, AND TUOLUMNE COUNTIES

	Rates	Fringes
Asbestos Removal Laborer		
All Counties.....	\$ 26.05	12.75
LABORER (Lead Removal)		

Area A.....	\$ 34.37	25.95
Area B.....	\$ 33.37	25.95

ASBESTOS REMOVAL-SCOPE OF WORK: Site mobilization; initial site clean-up; site preparation; removal of asbestos-containing materials from walls and ceilings; or from pipes, boilers and mechanical systems only if they are being scrapped; encapsulation, enclosure and disposal of asbestos-containing materials by hand or with equipment or machinery; scaffolding; fabrication of temporary wooden barriers; and assembly of decontamination stations.

LAB00261-006 07/01/2020

MARIN COUNTY

	Rates	Fringes
LABORER		
Mason Tender-Brick.....	\$ 34.09	23.71

FOOTNOTE: Refractory work where heat-protective clothing is required: \$2.00 per hour additional.

LAB00324-003 06/25/2018

DEL NORTE, HUMBOLDT, LAKE, AND MENDOCINO COUNTIES

	Rates	Fringes
LABORER (TRAFFIC CONTROL/LANE CLOSURE)		
Escort Driver, Flag Person..	\$ 29.54	23.65
Traffic Control Person I....	\$ 29.84	23.65
Traffic Control Person II...\$	27.34	23.65

TRAFFIC CONTROL PERSON I: Layout of traffic control, crash cushions, construction area and roadside signage.

TRAFFIC CONTROL PERSON II: Installation and removal of temporary/permanent signs, markers, delineators and crash cushions.

LAB00324-005 06/25/2018

	Rates	Fringes
Laborers: (CONSTRUCTION CRAFT LABORERS)		
Construction Specialist		
Group.....	\$ 30.49	23.20
GROUP 1.....	\$ 29.79	23.20
GROUP 1-a.....	\$ 30.01	23.20
GROUP 1-c.....	\$ 29.84	23.20
GROUP 1-e.....	\$ 30.34	23.20
GROUP 1-f.....	\$ 29.37	23.20
GROUP 2.....	\$ 29.64	23.20
GROUP 3.....	\$ 29.54	23.20
GROUP 4.....	\$ 23.23	23.20

See groups 1-b and 1-d under laborer classifications

Laborers: (GUNITE)		
GROUP 1.....	\$ 28.35	18.66
GROUP 2.....	\$ 27.85	18.66
GROUP 3.....	\$ 27.26	18.66
GROUP 4.....	\$ 27.14	18.66

Laborers: (WRECKING)		
GROUP 1.....	\$ 29.79	23.20
GROUP 2.....	\$ 29.64	23.20

Landscape Laborer (Gardeners, Horticultural & Landscape Laborers)		
Establishment Warranty		
Period.....	\$ 23.23	23.20
New Construction.....	\$ 29.54	23.20

FOOTNOTES:
Laborers working off or with or from bos'n chairs, swinging scaffolds, belts (not applicable to workers entitled to receive the wage rate set forth in Group 1-a): \$0.25 per hour additional.

LABORER CLASSIFICATIONS

CONSTRUCTION SPECIALIST GROUP: Asphalt ironer and raker; Chainsaw; Laser beam in connection with laborers' work;

Masonry and plasterer tender; Cast-in-place manhole form setter; Pressure pipelayer; Davis trencher - 300 or similar type (and all small trenchers); Blaster; Diamond driller; Multiple unit drill; Hydraulic drill

GROUP 1: Asphalt spreader boxes (all types); Barko, Wacker and similar type tampers; Buggymobile; Caulker, bander, pipewrapper, conduit layer, plastic pipelayer; Certified hazardous waste worker; Compactors of all types; Concrete and magnesite mixer, 1/2 yd. and under; Concrete pan work; Concrete sander; Concrete saw; Cribber and/or shoring; Cut granite curb setter; Dri-pak-it machine; Faller, logloader and bucket; Form raiser, slip forms; Green cutter; Headerboard, Hubsetter, aligner, by any method; High pressure blow pipe (1-1/2" or over, 100 lbs. pressure/over); Hydro seeder and similar type; Jackhammer operator; Jacking of pipe over 12 inches; Jackson and similar type compactor; Kettle tender, pot and worker applying asphalt, lay-kold, creosote, lime, caustic and similar type materials (applying means applying, dipping or handling of such materials); Lagging, sheeting, whaling, bracing, trenchjacking, lagging hammer; Magnesite, epoxyresin, fiberglass, mastic worker (wet or dry); No joint pipe and stripping of same, including repair of voids; Pavement breaker and spader, including tool grinder; Perma curb; Pipelayer (including grade checking in connection with pipelaying); Precast-manhole setter; Pressure pipe tester; Post hole digger, air, gas and electric; Power broom sweeper; Power tampers of all types (except as shown in Group 2); Ram set gun and stud gun; Riprap stonepaver and rock-slinger, including placing of sacked concrete and/or sand (wet or dry) and gabions and similar type; Rotary scarifier or multiple head concrete chipping scarifier; Roto and Ditch Witch; Rototiller; Sandblaster, pot, gun, nozzle operators; Signalling and rigging; Tank cleaner; Tree climber; Turbo blaster; Vibrascreed, bull float in connection with laborers' work; Vibrator

GROUP 1-a: Joy drill model TWM-2A; Gardner-Denver model DH143 and similar type drills; Track driller; Jack leg driller; Wagon driller; Mechanical drillers, all types regardless of type or method of power; Mechanical pipe layers, all types regardless of type or method of power; Blaster and powder; All work of loading, placing and blasting of all powder and explosives of whatever type regardless of method used for such loading and placing; High scalers (including drilling of same); Tree topper; Bit grinder

GROUP 1-b: Sewer cleaners shall receive \$4.00 per day above Group 1 wage rates. "Sewer cleaner" means any worker who handles or comes in contact with raw sewage in small diameter sewers. Those who work inside recently active, large diameter sewers, and all recently active sewer manholes, shall receive \$5.00 per day above Group 1 wage rates.

GROUP 1-c: Burning and welding in connection with laborers' work; Synthetic thermoplastics and similar type welding

GROUP 1-d: Maintenance and repair track and road beds (underground structures). All employees performing work covered herein shall receive \$.25 per hour above their regular rate for all work performed on underground structures not specifically covered herein. This paragraph shall not be construed to apply to work below ground level in open cut. It shall apply to cut and cover work of subway construction after the temporary cover has been placed.

GROUP 1-e: Work on and/or in bell hole footings and shafts thereof, and work on and in deep footings. (A deep footing is a hole 15 feet or more in depth.) In the event the depth of the footing is unknown at the commencement of excavation, and the final depth exceeds 15 feet, the deep footing wage rate would apply to all employees for each and every day worked on or in the excavation of the footing from the date of inception.

GROUP 1-f: Wire winding machine in connection with guniting or shot crete

GROUP 2: Asphalt shoveler; Cement dumper and handling dry cement or gypsum; Choke-setter and rigger (clearing work); Concrete bucket dumper and chute; Concrete chipping and grinding; Concrete laborer (wet or dry); Driller tender, chuck tender, nipper; Guinea chaser (stake), grout crew; High pressure nozzle, adductor; Hydraulic monitor (over 100

lbs. pressure); Loading and unloading, carrying and hauling of all rods and materials for use in reinforcing concrete construction; Pittsburgh chipper and similar type brush shredders; Sloper; Single foot, hand-held, pneumatic tamper; All pneumatic, air, gas and electric tools not listed in Groups 1 through 1-f; Jacking of pipe - under 12 inches

GROUP 3: Construction laborers, including bridge and general laborer; Dump, load spotter; Flag person; Fire watcher; Fence erector; Guardrail erector; Gardener, horticultural and landscape laborer; Jetting; Limber, brush loader and piler; Pavement marker (button setter); Maintenance, repair track and road beds; Streetcar and railroad construction track laborer; Temporary air and water lines, Victaulic or similar; Tool room attendant (jobsite only)

GROUP 4: All clean-up work of debris, grounds and building including but not limited to: street cleaner; cleaning and washing windows; brick cleaner (jobsite only); material cleaner (jobsite only). The classification "material cleaner" is to be utilized under the following conditions:

A: at demolition site for the salvage of the material.

B: at the conclusion of a job where the material is to be salvaged and stocked to be reused on another job.

C: for the cleaning of salvage material at the jobsite or temporary jobsite yard.

The material cleaner classification should not be used in the performance of "form stripping, cleaning and oiling and moving to the next point of erection".

GUNITE LABORER CLASSIFICATIONS

GROUP 1: Structural Nozzleman

GROUP 2: Nozzleman, Gunman, Potman, Groundman

GROUP 3: Reboundman

GROUP 4: Gunite laborer

WRECKING WORK LABORER CLASSIFICATIONS

GROUP 1: Skilled wrecker (removing and salvaging of sash, windows and materials)

GROUP 2: Semi-skilled wrecker (salvaging of other building materials)

LAB00324-007 06/25/2018

DEL NORTE, HUMBOLDT, LAKE, AND MENDOCINO COUNTIES

	Rates	Fringes
Tunnel and Shaft Laborers:		
GROUP 1.....	\$ 37.82	24.11
GROUP 2.....	\$ 37.59	24.11
GROUP 3.....	\$ 37.34	24.11
GROUP 4.....	\$ 36.89	24.11
GROUP 5.....	\$ 36.35	24.11
Shotcrete Specialist.....	\$ 38.34	24.11

TUNNEL AND SHAFT CLASSIFICATIONS

GROUP 1: Diamond driller; Groundmen; Gunite and shotcrete nozzlemen

GROUP 2: Rodmen; Shaft work & raise (below actual or excavated ground level)

GROUP 3: Bit grinder; Blaster, driller, powdermen, heading; Cherry pickermen - where car is lifted; Concrete finisher in tunnel; Concrete screedman; Grout pumpman and potman; Gunite & shotcrete gunman & potman; Headermen; High pressure nozzleman; Miner - tunnel, including top and bottom man on shaft and raise work; Nipper; Nozzleman on slick line; Sandblaster - potman, Robotic Shotcrete Placer, Segment Erector, Tunnel Muck Hauler, Steel Form raiser and setter; Timberman, retimberman (wood or steel or substitute materials therefore); Tugger (for tunnel laborer work); Cable tender; Chuck tender; Powderman - primer house

GROUP 4: Vibrator operator, pavement breaker; Bull gang - muckers, trackmen; Concrete crew - includes rodding and spreading, Dumpmen (any method)

GROUP 5: Grout crew; Reboundman; Swamper/ Brakeman

LAB00324-009 07/01/2018

DEL NORTE, HUMBOLDT, LAKE, MENDOCINO, NAPA, SOLANO, AND SONOMA COUNTIES

	Rates	Fringes
LABORER		
Mason Tender-Brick.....	\$ 31.45	22.20

FOOTNOTE: Refractory work where heat-protective clothing is required: \$2.00 per hour additional.

PAIN0016-021 01/01/2021

LAKE AND MENDOCINO COUNTIES

	Rates	Fringes
Painters:.....	\$ 45.22	25.48

PAIN1034-001 06/01/1993

DEL NORTE AND HUMBOLDT COUNTIES

	Rates	Fringes
Painters:		
Brush & Roller.....	\$ 13.35	2.94
Sandblaster, spray, structural steel & swing stage.....	\$ 13.60	2.94

PAIN1176-001 07/01/2020

HIGHWAY IMPROVEMENT

	Rates	Fringes
Parking Lot Striping/Highway Marking:		
GROUP 1.....	\$ 38.48	16.88
GROUP 2.....	\$ 32.71	16.88
GROUP 3.....	\$ 33.09	16.88

CLASSIFICATIONS

GROUP 1: Striper: Layout and application of painted traffic stripes and marking; hot thermo plastic; tape, traffic stripes and markings

GROUP 2: Gamecourt & Playground Installer

GROUP 3: Protective Coating, Pavement Sealing

PLAS0300-005 07/01/2017

	Rates	Fringes
CEMENT MASON/CONCRETE FINISHER...	\$ 33.49	23.67

PLUM0038-004 07/01/2020

LAKE AND MENDOCINO COUNTIES

	Rates	Fringes
Landscape/Irrigation Fitter (Underground/Utility Fitter)....	\$ 63.04	31.48
PLUMBER		
Work on wooden frame structures 5 stories or less excluding high-rise buildings and commercial work such as hospitals, prisons, hotels, schools, casinos, wastewater treatment plants, and research facilities as well as refrigeration pipefitting, service and repair work - MARKET		

RECOVERY RATE.....	\$ 64.86	43.54
All other work - NEW		
CONSTRUCTION RATE.....	\$ 76.30	45.27

* PLUM0355-005 07/01/2021

DEL NORTE AND HUMBOLDT COUNTIES:

	Rates	Fringes
Underground Utility Worker /Landscape Fitter.....	\$ 31.00	16.80

SHEE0104-016 06/29/2020

	Rates	Fringes
SHEET METAL WORKER		
Mechanical contracts		
\$200,000 or less.....	\$ 55.92	45.29
All other work.....	\$ 64.06	46.83

* TEAM0094-001 07/01/2021

	Rates	Fringes
Truck drivers:		
GROUP 1.....	\$ 35.15	31.42
GROUP 2.....	\$ 35.45	31.42
GROUP 3.....	\$ 35.75	31.42
GROUP 4.....	\$ 36.10	31.42
GROUP 5.....	\$ 36.45	31.42

FOOTNOTES:

Articulated dump truck; Bulk cement spreader (with or without auger); Dumpcrete truck; Skid truck (debris box); Dry pre-batch concrete mix trucks; Dumpster or similar type; Slurry truck: Use dump truck yardage rate.
 Heater planer; Asphalt burner; Scarifier burner; Industrial lift truck (mechanical tailgate); Utility and clean-up truck: Use appropriate rate for the power unit or the equipment utilized.

TRUCK DRIVER CLASSIFICATIONS

GROUP 1: Dump trucks, under 6 yds.; Single unit flat rack (2-axle unit); Nipper truck (when flat rack truck is used appropriate flat rack shall apply); Concrete pump truck (when flat rack truck is used appropriate flat rack shall apply); Concrete pump machine; Fork lift and lift jitneys; Fuel and/or grease truck driver or fuel person; Snow buggy; Steam cleaning; Bus or personhaul driver; Escort or pilot car driver; Pickup truck; Teamster oiler/greaser and/or serviceperson; Hook tender (including loading and unloading); Team driver; Tool room attendant (refineries)

GROUP 2: Dump trucks, 6 yds. and under 8 yds.; Transit mixers, through 10 yds.; Water trucks, under 7,000 gals.; Jetting trucks, under 7,000 gals.; Single-unit flat rack (3-axle unit); Highbed heavy duty transport; Scissor truck; Rubber-tired muck car (not self-loaded); Rubber-tired truck jumbo; Winch truck and "A" frame drivers; Combination winch truck with hoist; Road oil truck or bootperson; Buggymobile; Ross, Hyster and similar straddle carriers; Small rubber-tired tractor

GROUP 3: Dump trucks, 8 yds. and including 24 yds.; Transit mixers, over 10 yds.; Water trucks, 7,000 gals. and over; Jetting trucks, 7,000 gals. and over; Vacuum trucks under 7500 gals. Trucks towing tilt bed or flat bed pull trailers; Lowbed heavy duty transport; Heavy duty transport tiller person; Self-propelled street sweeper with self-contained refuse bin; Boom truck - hydro-lift or Swedish type extension or retracting crane; P.B. or similar type self-loading truck; Tire repairperson; Combination bootperson and road oiler; Dry distribution truck (A bootperson when employed on such equipment, shall receive the rate specified for the classification of road oil trucks or bootperson); Ammonia nitrate distributor, driver and mixer; Snow Go and/or plow

GROUP 4: Dump trucks, over 25 yds. and under 65 yds.; Water pulls - DW 10's, 20's, 21's and other similar equipment when pulling Aqua/pak or water tank trailers; Helicopter pilots (when transporting men and materials); Lowbed Heavy Duty Transport up to including 7 axles; DW10's, 20's, 21's and other similar Cat type, Terra Cobra, LeTourneau Pulls,

Tournorocker, Euclid and similar type equipment when pulling fuel and/or grease tank trailers or other miscellaneous trailers; Vacuum Trucks 7500 gals and over and truck repairman

GROUP 5: Dump trucks, 65 yds. and over; Holland hauler; Low bed Heavy Duty Transport over 7 axles

WELDERS - Receive rate prescribed for craft performing operation to which welding is incidental.

=====
Note: Executive Order (EO) 13706, Establishing Paid Sick Leave for Federal Contractors applies to all contracts subject to the Davis-Bacon Act for which the contract is awarded (and any solicitation was issued) on or after January 1, 2017. If this contract is covered by the EO, the contractor must provide employees with 1 hour of paid sick leave for every 30 hours they work, up to 56 hours of paid sick leave each year. Employees must be permitted to use paid sick leave for their own illness, injury or other health-related needs, including preventive care; to assist a family member (or person who is like family to the employee) who is ill, injured, or has other health-related needs, including preventive care; or for reasons resulting from, or to assist a family member (or person who is like family to the employee) who is a victim of, domestic violence, sexual assault, or stalking. Additional information on contractor requirements and worker protections under the EO is available at www.dol.gov/whd/govcontracts.

Unlisted classifications needed for work not included within the scope of the classifications listed may be added after award only as provided in the labor standards contract clauses (29CFR 5.5 (a) (1) (ii)).

The body of each wage determination lists the classification and wage rates that have been found to be prevailing for the cited type(s) of construction in the area covered by the wage determination. The classifications are listed in alphabetical order of ""identifiers"" that indicate whether the particular rate is a union rate (current union negotiated rate for local), a survey rate (weighted average rate) or a union average rate (weighted union average rate).

Union Rate Identifiers

A four letter classification abbreviation identifier enclosed in dotted lines beginning with characters other than ""SU"" or ""UAVG"" denotes that the union classification and rate were prevailing for that classification in the survey. Example: PLUM0198-005 07/01/2014. PLUM is an abbreviation identifier of the union which prevailed in the survey for this classification, which in this example would be Plumbers. 0198 indicates the local union number or district council number where applicable, i.e., Plumbers Local 0198. The next number, 005 in the example, is an internal number used in processing the wage determination. 07/01/2014 is the effective date of the most current negotiated rate, which in this example is July 1, 2014.

Union prevailing wage rates are updated to reflect all rate changes in the collective bargaining agreement (CBA) governing this classification and rate.

Survey Rate Identifiers

Classifications listed under the ""SU"" identifier indicate that no one rate prevailed for this classification in the survey and the published rate is derived by computing a weighted average rate based on all the rates reported in the survey for that classification. As this weighted average rate includes all rates reported in the survey, it may include both union and non-union rates. Example: SULA2012-007 5/13/2014. SU indicates the rates are survey rates based on a weighted average calculation of rates and are not majority rates. LA indicates the State of Louisiana. 2012 is the year of survey on which these classifications and rates are based. The next number, 007 in the example, is an internal number used in producing the wage determination. 5/13/2014 indicates the survey completion date for the classifications and rates under that identifier.

Survey wage rates are not updated and remain in effect until a new survey is conducted.

Union Average Rate Identifiers

Classification(s) listed under the UAVG identifier indicate that no single majority rate prevailed for those classifications; however, 100% of the data reported for the classifications was union data. EXAMPLE: UAVG-OH-0010 08/29/2014. UAVG indicates that the rate is a weighted union average rate. OH indicates the state. The next number, 0010 in the example, is an internal number used in producing the wage determination. 08/29/2014 indicates the survey completion date for the classifications and rates under that identifier.

A UAVG rate will be updated once a year, usually in January of each year, to reflect a weighted average of the current negotiated/CBA rate of the union locals from which the rate is based.

WAGE DETERMINATION APPEALS PROCESS

1.) Has there been an initial decision in the matter? This can be:

- * an existing published wage determination
- * a survey underlying a wage determination
- * a Wage and Hour Division letter setting forth a position on a wage determination matter
- * a conformance (additional classification and rate) ruling

On survey related matters, initial contact, including requests for summaries of surveys, should be with the Wage and Hour Regional Office for the area in which the survey was conducted because those Regional Offices have responsibility for the Davis-Bacon survey program. If the response from this initial contact is not satisfactory, then the process described in 2.) and 3.) should be followed.

With regard to any other matter not yet ripe for the formal process described here, initial contact should be with the Branch of Construction Wage Determinations. Write to:

Branch of Construction Wage Determinations
Wage and Hour Division
U.S. Department of Labor
200 Constitution Avenue, N.W.
Washington, DC 20210

2.) If the answer to the question in 1.) is yes, then an interested party (those affected by the action) can request review and reconsideration from the Wage and Hour Administrator (See 29 CFR Part 1.8 and 29 CFR Part 7). Write to:

Wage and Hour Administrator
U.S. Department of Labor
200 Constitution Avenue, N.W.
Washington, DC 20210

The request should be accompanied by a full statement of the interested party's position and by any information (wage payment data, project description, area practice material, etc.) that the requestor considers relevant to the issue.

3.) If the decision of the Administrator is not favorable, an interested party may appeal directly to the Administrative Review Board (formerly the Wage Appeals Board). Write to:

Administrative Review Board
U.S. Department of Labor
200 Constitution Avenue, N.W.
Washington, DC 20210

4.) All decisions by the Administrative Review Board are final.

=====
END OF GENERAL DECISION"

CONTRACT CHANGE ORDER

CONTRACT CHANGE ORDER NUMBER	1	SUPPL. NO.	
------------------------------	---	------------	--

DATE PREPARED BY RESIDENT ENGINEER: March 17, 2023PROJECT NAME: STORM DAMAGE REPAIR TO TELEGRAPH CREEK ROAD (4A150) AT PM 1.90PROJECT NO. FEMA 4308-DR-CA PW-1433 CONTRACT NO. 217345TO: GR WILCOX ENTERPRISES, INC., P.O. BOX 186, WHITETHORN, CA 95589

YOU ARE HEREBY DIRECTED TO MAKE THE HEREIN DESCRIBED CHANGES FROM THE PLANS AND SPECIFICATIONS OR TO DO THE FOLLOWING DESCRIBED WORK NOT INCLUDED IN THE PLANS AND SPECIFICATIONS FOR THIS CONTRACT. NOTE THIS CHANGE ORDER IS NOT EFFECTIVE UNTIL APPROVED BY THE DIRECTOR OF PUBLIC WORKS

DESCRIPTION OF WORK TO BE DONE, ESTIMATE OF QUANTITIES, AND PRICES PAID. (SEGREGATE BETWEEN ADDITIONAL WORK AT CONTRACT PRICE, AGREED PRICE AND FORCE ACCOUNT.) UNLESS OTHERWISE STATED, RATES FOR RENTAL OF EQUIPMENT COVER ONLY SUCH TIME AS EQUIPMENT IS ACTUALLY USED AND NO ALLOWANCE WILL BE MADE FOR IDLE TIME. THE LAST PERCENTAGE SHOWN IS THE NET ACCUMULATED INCREASE OR DECREASE FROM THE ORIGINAL QUANTITY IN THE ENGINEER'S ESTIMATE.

EXTRA WORK AT AGREED PRICE:

Furnish 400 CY of import borrow for embankment at a cost of \$55/CY. The unit cost provides \$ 22,000.00 compensation for purchasing and delivering the material. Placement of the material is paid by Item 16, Embankment.

The contractor shall receive and accept the agreed lump sum of **\$22,000.00** for furnishing material suitable for placement as embankment. This sum constitutes full and complete compensation for furnishing all labor, material, equipment, tools, and incidentals including all markups by reason of this change.

A determination of the delay in completion of the project due to the work specified in this change order has been made in accordance with Section 8-1.02, Schedule, and Section 8-1.07, Delay, of the *Standard Specifications*. A time adjustment of three (3) days is granted for 10/25/2022, 10/26/2022, and 10/27/2022.

ESTIMATED TOTAL DECREASE = \$ 22,000.00BY REASON OF THIS CHANGE, THE CONTRACT TIME WILL BE INCREASED BY **3 DAYS****SUBMITTED BY:**

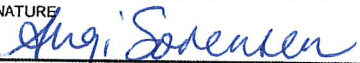
SIGNATURE 	PRINT NAME AND TITLE ANGI SORENSEN, CONSTRUCTION ENGINEER	DATE 6/1/2023
--------------------------------------------------------------------------------------------------	--------------------------------------------------------------	------------------

DIRECTOR APPROVAL BY:

SIGNATURE 	PRINT NAME AND TITLE TOM MATTSON, DIRECTOR OF PUBLIC WORKS	DATE 6/2/23
--------------------------------------------------------------------------------------------------	---------------------------------------------------------------	----------------

WE, THE UNDERSIGNED CONTRACTOR, HAVE GIVEN CAREFUL CONSIDERATION TO THIS CHANGE PROPOSED AND AGREE, IF THIS PROPOSAL IS APPROVED, THAT WE WILL PROVIDE ALL EQUIPMENT, FURNISH ALL MATERIALS, EXCEPT AS MAY OTHERWISE BE NOTED ABOVE, AND PERFORM ALL SERVICES NECESSARY FOR THE WORK ABOVE SPECIFIED, AND WILL ACCEPT AS FULL PAYMENT, THEREFORE, THE PRICES SHOWN ABOVE. NOTE: IF YOU, THE CONTRACTOR, DO NOT SIGN ACCEPTANCE OF THIS ORDER, YOUR ATTENTION IS DIRECTED TO THE REQUIREMENTS OF THE SPECIFICATION AS TO PROCEEDING WITH THE ORDERED WORK AND FILING A WRITTEN PROTEST WITHIN THE TIME THEREIN SPECIFIED.

CONTRACTOR ACCEPTANCE BY:

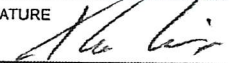
SIGNATURE 	PRINT NAME AND TITLE RAY WILCOX President	DATE 5-31-23
--------------------------------------------------------------------------------------------------	----------------------------------------------	-----------------

CONTRACT CHANGE ORDER NUMBER	2	SUPPL. NO.	
------------------------------	---	------------	--

DATE PREPARED BY RESIDENT ENGINEER: May 30, 2023

PROJECT NAME: STORM DAMAGE REPAIR TO TELEGRAPH CREEK ROAD (4A150) AT PM 1.90

PROJECT NO. FEMA 4308-DR-CA PW-1433 CONTRACT NO. 217345

TO: GR WILCOX ENTERPRISES, INC., P.O. BOX 186, WHITETHORN, CA 95589

YOU ARE HEREBY DIRECTED TO MAKE THE HEREIN DESCRIBED CHANGES FROM THE PLANS AND SPECIFICATIONS OR TO DO THE FOLLOWING DESCRIBED WORK NOT INCLUDED IN THE PLANS AND SPECIFICATIONS FOR THIS CONTRACT. **NOTE THIS CHANGE ORDER IS NOT EFFECTIVE UNTIL APPROVED BY THE DIRECTOR OF PUBLIC WORKS**

DESCRIPTION OF WORK TO BE DONE, ESTIMATE OF QUANTITIES, AND PRICES PAID. (SEGREGATE BETWEEN ADDITIONAL WORK AT CONTRACT PRICE, AGREED PRICE AND FORCE ACCOUNT.) UNLESS OTHERWISE STATED, RATES FOR RENTAL OF EQUIPMENT COVER ONLY SUCH TIME AS EQUIPMENT IS ACTUALLY USED AND NO ALLOWANCE WILL BE MADE FOR IDLE TIME. THE LAST PERCENTAGE SHOWN IS THE NET ACCUMULATED INCREASE OR DECREASE FROM THE ORIGINAL QUANTITY IN THE ENGINEER'S ESTIMATE.

INCREASE IN CONTRACT ITEMS AT CONTRACT PRICES

ITEM NO. 4	PORTABLE CHANGEABLE MESSAGE SIGN				
	1 EA	100.00%	@	\$ 5,163.00 / EA	\$ 5,163.00
ITEM NO. 18	ROLLED EROSION CONTROL PRODUCT (BLANKET)				
	27.0 SF	7.76%	@	\$ 11.76 / SF	\$ 317.52
ITEM NO. 31	18" PLASTIC PIPE (HEAT-FUSED HDPE)				
	10 LF	33.33%	@	\$ 124.17 / LF	\$ 1,241.70
ITEM NO. 43	ROCK SLOPE PROTECTION (1/4 T, CLASS V, METHOD B) (CY)				
	48 CY	35.56%	@	\$ 176.84 / CY	\$ 8,488.32
TOTAL INCREASE =					\$ 15,210.54

No adjustment to contract unit prices for Item 4, Portable Changeable Message Sign, and Item 43, Rock Slope Protection (1/4 T, Class V, Method B) (CY), will be made in accordance with Section 9-1.06B, "Increases of More Than 25 Percent," of the *Standard Specifications* by reason of this change order.

DECREASE IN CONTRACT ITEMS AT CONTRACT PRICES

ITEM NO. 2	CONSTRUCTION AREA SIGNS				
	-6 EA	-60.00%	@	\$ 225.00 / EA	\$ (1,350.00)
ITEM NO. 11	ROADWAY EXCAVATION				
	-45 CY	-31.69%	@	\$ 34.80 / CY	\$ (1,566.00)
ITEM NO. 17	DRY SEED				
	-1095.0 SF	-18.23%	@	\$ 0.66 / SF	\$ (722.70)
ITEM NO. 20	STRAW				
	-1337 SF	-46.50%	@	\$ 0.56 / SF	\$ (748.72)
ITEM NO. 21	WILLOW STAKES				
	-86 EA	-43.00%	@	\$ 67.20 / EA	\$ (5,779.20)
ITEM NO. 23	CLASS 2 AGGREGATE BASE (CY)				
	-28 CY	-19.05%	@	\$ 98.16 / CY	\$ (2,748.48)
ITEM NO. 24	HOT MIX ASPHALT (TYPE A)				
	-15 TN	-13.64%	@	\$ 275.00 / TN	\$ (4,125.00)
ITEM NO. 25	PLACE HOT MIX ASPHALT DIKE (TYPE A)				
	-37 LF	-8.41%	@	\$ 21.28 / LF	\$ (787.36)

COUNTY OF HUMBOLDT
DEPARTMENT OF PUBLIC WORKS
1106 SECOND STREET
EUREKA, CA 95501

CONTRACT CHANGE ORDER

PAGE 2 OF 2

DECREASE IN CONTRACT ITEMS AT CONTRACT PRICES (CONTINUED)

ITEM NO. 27	STRUCTURAL CONCRETE (ARCH CULVERT-FOOTINGS)	-17 CY	-16.35%	@	\$ 605.00 / CY	\$ (10,285.00)
ITEM NO. 28	STRUCTURAL CONCRETE (HEADWALL & WINGWALLS)	-28.00 CY	-24.56%	@	\$ 696.49 / CY	\$ (19,501.72)
ITEM NO. 30	BAR REINFORCING STEEL	-1,760 LB	-10.02%	@	\$ 4.40 / LB	\$ (7,744.00)
ITEM NO. 37	CONCRETE ANCHOR AND CABLE ASSEMBLY	-1.00 EA	-100.00%	@	\$ 3,350.00 / EA	\$ (3,350.00)
ITEM NO. 49	PAINT TRAFFIC STRIPE (2 COAT)	-220.00 LF	-100.00%	@	\$ 13.12 / LF	\$ (2,886.40)

TOTAL DECREASE = \$ (61,594.58)

The quantity decreases shown for Item No. 23, Class 2 Aggregate Base (CY); Item 27, Structural Concrete (Arch Culvert Footings); Item No. 28, Structural Concrete (Headwall & Wingwalls); and Item No. 30, Bar Reinforcing Steel, when combined with the quantities shown in the bid item list, and as modified by any previous change orders or revisions to dimensions made by the engineer, shall be the final quantities for which payment will be made.

No adjustment to contract unit price for Item 21, Willow Stakes, will be made in accordance with Section 9-1.06C, "Decreases of More Than 25 Percent," of the *Standard Specifications* by reason of this change order.

In accordance with Section 9-1.06D, "Eliminated Items," of the *Standard Specifications*, the adjustment due to the elimination of Item 37, Concrete Anchor and Cable Assembly, and Item 49, Paint Traffic Stripe (2 Coat), is zero.

A determination of the delay in completion of the project due to the work specified in this change order has been made in accordance with Section 8-1.02, Schedule, and Section 8-1.07, Delay, of the *Standard Specifications*. A time adjustment of forty (40) days is granted because weather and permit restrictions prevented the contractor from performing controlling operations at Telegraph Creek Road P.M. 1.90 in parallel with work on Puma Drive as anticipated in the combined bid documents.

ESTIMATED TOTAL INCREASE = \$ (46,384.04)

BY REASON OF THIS CHANGE, THE CONTRACT TIME WILL BE INCREASED BY 40 WORKING DAYS

SUBMITTED BY:

SIGNATURE 	PRINT NAME AND TITLE ANGI SORENSEN, CONSTRUCTION ENGINEER	DATE 6/11/2023
--------------------------------------------------------------------------------------------------	--------------------------------------------------------------	-------------------

DIRECTOR APPROVAL BY:

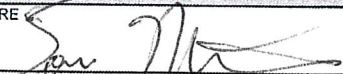
SIGNATURE 	PRINT NAME AND TITLE TOM MATTSO, DIRECTOR OF PUBLIC WORKS	DATE 6/2/23
--------------------------------------------------------------------------------------------------	--------------------------------------------------------------	----------------

WE, THE UNDERSIGNED CONTRACTOR, HAVE GIVEN CAREFUL CONSIDERATION TO THIS CHANGE PROPOSED AND AGREE, IF THIS PROPOSAL IS APPROVED, THAT WE WILL PROVIDE ALL EQUIPMENT, FURNISH ALL MATERIALS, EXCEPT AS MAY OTHERWISE BE NOTED ABOVE, AND PERFORM ALL SERVICES NECESSARY FOR THE WORK ABOVE SPECIFIED, AND WILL ACCEPT AS FULL PAYMENT, THEREFORE, THE PRICES SHOWN ABOVE. NOTE: IF YOU, THE CONTRACTOR, DO NOT SIGN ACCEPTANCE OF THIS ORDER, YOUR ATTENTION IS DIRECTED TO THE REQUIREMENTS OF THE SPECIFICATION AS TO PROCEEDING WITH THE ORDERED WORK AND FILING A WRITTEN PROTEST WITHIN THE TIME THEREIN SPECIFIED.

CONTRACTOR ACCEPTANCE BY:

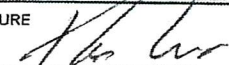
SIGNATURE 	PRINT NAME AND TITLE RAY WILCOX, PRESIDENT	DATE 5-31-23
--------------------------------------------------------------------------------------------------	-----------------------------------------------	-----------------

CONTRACT CHANGE ORDER NUMBER	1	SUPPL. NO.	
------------------------------	---	------------	--

DATE PREPARED BY RESIDENT ENGINEER: March 18, 2022

PROJECT NAME: STORM DAMAGE REPAIR TO PUMA DRIVE (4A125) AT PM 0.10

PROJECT NO. FEMA 4434-DR-CA PW-212 CONTRACT NO. 219342

TO: GR WILCOX ENTERPRISES, INC., P.O. BOX 186, WHITETHORN, CA 95589

YOU ARE HEREBY DIRECTED TO MAKE THE HEREIN DESCRIBED CHANGES FROM THE PLANS AND SPECIFICATIONS OR TO DO THE FOLLOWING DESCRIBED WORK NOT INCLUDED IN THE PLANS AND SPECIFICATIONS FOR THIS CONTRACT. **NOTE THIS CHANGE ORDER IS NOT EFFECTIVE UNTIL APPROVED BY THE DIRECTOR OF PUBLIC WORKS**

DESCRIPTION OF WORK TO BE DONE, ESTIMATE OF QUANTITIES, AND PRICES PAID. (SEGREGATE BETWEEN ADDITIONAL WORK AT CONTRACT PRICE, AGREED PRICE AND FORCE ACCOUNT.) UNLESS OTHERWISE STATED, RATES FOR RENTAL OF EQUIPMENT COVER ONLY SUCH TIME AS EQUIPMENT IS ACTUALLY USED AND NO ALLOWANCE WILL BE MADE FOR IDLE TIME. THE LAST PERCENTAGE SHOWN IS THE NET ACCUMULATED INCREASE OR DECREASE FROM THE ORIGINAL QUANTITY IN THE ENGINEER'S ESTIMATE.

INCREASE IN CONTRACT ITEMS AT CONTRACT PRICES

ITEM NO. 17	DRY SEED					
	1204 SF	165.84%	@	\$ 0.66 / SF		\$ 794.64
ITEM NO. 20	STRAW					
	1721 SF	823.44%	@	\$ 0.56 / SF		\$ 963.76
ITEM NO. 24	HOT MIX ASPHALT (TYPE A)					
	9.44 TN	20.52%	@	\$ 275.00 / TN		\$ 2,596.00
ITEM NO. 31	18" PLASTIC PIPE (HEAT-FUSED HDPE)					
	3 LF	4.69%	@	\$ 124.17 / LF		\$ 372.51
ITEM NO. 43	ROCK SLOPE PROTECTION (1/4 T, CLASS V, METHOD B) (CY)					
	16 CY	177.78%	@	\$ 176.84 / CY		\$ 2,829.44
ITEM NO. 46	MIDWEST GUARDRAIL SYSTEM (STEEL POST)					
	62.5 LF	83.33%	@	\$ 220.00 / LF		\$ 13,750.00
TOTAL INCREASE =						\$ 21,306.35

No adjustment to contract unit prices for Item 43, Rock Slope Protection (1/4 T, Class V, Method B) (CY), and Item 46, Midwest Guardrail System (Steel Post), will be made in accordance with Section 9-1.06B, "Increases of More Than 25 Percent," of the *Standard Specifications* by reason of this change order.

DECREASE IN CONTRACT ITEMS AT CONTRACT PRICES

ITEM NO. 2	CONSTRUCTION AREA SIGNS					
	-1 EA	-100.00%	@	\$ 225.00 / EA		\$ (225.00)
ITEM NO. 11	ROADWAY EXCAVATION					
	-13 CY	-20.63%	@	\$ 34.80 / CY		\$ (452.40)
ITEM NO. 13	STRUCTURE EXCAVATION (RETAINING WALL)					
	-9 CY	-1.40%	@	\$ 27.17 / CY		\$ (244.53)
ITEM NO. 15	STRUCTURE BACKFILL (WWW RETAINING WALL)					
	-10 CY	-2.17%	@	\$ 56.00 / CY		\$ (560.00)
ITEM NO. 18	ROLLED EROSION CONTROL PRODUCT (BLANKET)					
	-517 SY	-100.00%	@	\$ 11.76 / SY		\$ (6,079.92)

DECREASE IN CONTRACT ITEMS AT CONTRACT PRICES (CONTINUED)

ITEM NO. 23	CLASS 2 AGGREGATE BASE (CY)					
	-20 CY	-25.97%	@	\$ 98.16 / CY		\$ (1,963.20)
ITEM NO. 26	MECHANICALLY STABILIZED EMBANKMENT (WIRE WALL)					
	-32 SF	-3.39%	@	\$ 43.13 / SF		\$ (1,380.16)
ITEM NO. 33	6" PERFORATED PLASTIC PIPE UNDERDRAIN					
	-25 LF	-23.15%	@	\$ 12.60 / LF		\$ (315.00)
ITEM NO. 35	GEOCOMPOSITE DRAIN					
	-188 SF	-20.61%	@	\$ 6.56 / SF		\$ (1,233.28)
ITEM NO. 49	PAINT TRAFFIC STRIPE (2 COAT)					
	-120.00 LF	-100.00%	@	\$ 13.12 / LF		\$ (1,574.40)

TOTAL DECREASE = \$ (14,027.89)

In accordance with Section 9-1.06D, "Eliminated Items," of the *Standard Specifications*, the adjustment due to the elimination of Item No. 2, Construction Area Signs; Item 18, Rolled Erosion Control Product (Blanket); and Item No. 49, Paint Traffic Stripe (2 Coat), is zero.

The quantity decreases shown for Item No. 13, Structure Excavation (Retaining Wall); Item 15, Structure Backfill (WWW Retaining Wall); Item No. 23, Class 2 Aggregate Base; and Item No. 26, Mechanically Stabilized Embankment (Wire Wall), when combined with the quantities shown in the bid item list, and as modified by any previous change orders or revisions to dimensions made by the engineer, shall be the final quantities for which payment will be made.

A determination of the delay in completion of the project due to the work specified in this change order has been made in accordance with Section 8-1.02, Schedule, and Section 8-1.07, Delay, of the *Standard Specifications*. These changes did not delay controlling activities; therefore, no time extension is granted.

ESTIMATED TOTAL INCREASE = \$ 7,278.46

BY REASON OF THIS CHANGE, THE CONTRACT TIME WILL BE INCREASED BY 0 DAYS

SUBMITTED BY:

SIGNATURE 	PRINT NAME AND TITLE ANGI SORENSEN, CONSTRUCTION ENGINEER	DATE 3-28-2022
--------------------------------------------------------------------------------------------------	--------------------------------------------------------------	-------------------

DIRECTOR APPROVAL BY:

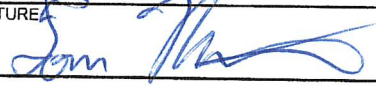
SIGNATURE 	PRINT NAME AND TITLE TOM MATTSON, DIRECTOR OF PUBLIC WORKS	DATE 3/28/22
--------------------------------------------------------------------------------------------------	---------------------------------------------------------------	-----------------

WE, THE UNDERSIGNED CONTRACTOR, HAVE GIVEN CAREFUL CONSIDERATION TO THIS CHANGE PROPOSED AND AGREE, IF THIS PROPOSAL IS APPROVED, THAT WE WILL PROVIDE ALL EQUIPMENT, FURNISH ALL MATERIALS, EXCEPT AS MAY OTHERWISE BE NOTED ABOVE, AND PERFORM ALL SERVICES NECESSARY FOR THE WORK ABOVE SPECIFIED, AND WILL ACCEPT AS FULL PAYMENT, THEREFORE, THE PRICES SHOWN ABOVE. NOTE: IF YOU, THE CONTRACTOR, DO NOT SIGN ACCEPTANCE OF THIS ORDER, YOUR ATTENTION IS DIRECTED TO THE REQUIREMENTS OF THE SPECIFICATION AS TO PROCEEDING WITH THE ORDERED WORK AND FILING A WRITTEN PROTEST WITHIN THE TIME THEREIN SPECIFIED.

CONTRACTOR ACCEPTANCE BY:

SIGNATURE 	PRINT NAME AND TITLE RAY WILCOX, PRESIDENT	DATE 3-28-22
--------------------------------------------------------------------------------------------------	-----------------------------------------------	-----------------

CONTRACT CHANGE ORDER NUMBER	2	SUPPL. NO.	
------------------------------	---	------------	--

DATE PREPARED BY RESIDENT ENGINEER: March 29, 2022

PROJECT NAME: STORM DAMAGE REPAIR TO PUMA DRIVE (4A125) AT PM 0.10

PROJECT NO. FEMA 4434-DR-CA PW-212 CONTRACT NO. 219342

TO: GR WILCOX ENTERPRISES, INC., P.O. BOX 186, WHITETHORN, CA 95589

YOU ARE HEREBY DIRECTED TO MAKE THE HEREIN DESCRIBED CHANGES FROM THE PLANS AND SPECIFICATIONS OR TO DO THE FOLLOWING DESCRIBED WORK NOT INCLUDED IN THE PLANS AND SPECIFICATIONS FOR THIS CONTRACT. **NOTE THIS CHANGE ORDER IS NOT EFFECTIVE UNTIL APPROVED BY THE DIRECTOR OF PUBLIC WORKS**

DESCRIPTION OF WORK TO BE DONE, ESTIMATE OF QUANTITIES, AND PRICES PAID. (SEGREGATE BETWEEN ADDITIONAL WORK AT CONTRACT PRICE, AGREED PRICE AND FORCE ACCOUNT.) UNLESS OTHERWISE STATED, RATES FOR RENTAL OF EQUIPMENT COVER ONLY SUCH TIME AS EQUIPMENT IS ACTUALLY USED AND NO ALLOWANCE WILL BE MADE FOR IDLE TIME. THE LAST PERCENTAGE SHOWN IS THE NET ACCUMULATED INCREASE OR DECREASE FROM THE ORIGINAL QUANTITY IN THE ENGINEER'S ESTIMATE.

EXTRA WORK AT AGREED PRICE:

- 2a) Import structure backfill material to make up for deficiency of excavated materials. \$ 17,250.00
- 2b) Connect existing 8" underdrain to new drainage inlet. \$ 1,000.00
- 2c) Remove slide debris at road closure. \$ 2,000.00

For this work, the contractor shall receive and accept the agreed lump sum of **\$20,250.00** for importing structure backfill, connecting existing underdrain to new drainage inlet, and removing slide debris. This sum constitutes full and complete compensation for furnishing all labor, material, equipment, tools, and incidentals including all markups by reason of this change.

A determination of the delay in completion of the project due to the work specified in this change order has been made in accordance with Section 8-1.02, Schedule, and Section 8-1.07, Delay, of the *Standard Specifications*. An extension of three (3) working days shall be granted for change order work performed on 1/27/2022, 1/28/2022, and 1/31/2022.

ESTIMATED TOTAL INCREASE = \$ 20,250.00

BY REASON OF THIS CHANGE, THE CONTRACT TIME WILL BE INCREASED BY 3 WORKING DAYS

SUBMITTED BY:

SIGNATURE 	PRINT NAME AND TITLE ANGI SORENSEN, CONSTRUCTION ENGINEER	DATE 3-30-2022
--------------------------------------------------------------------------------------------------	--------------------------------------------------------------	-------------------

DIRECTOR APPROVAL BY:

SIGNATURE 	PRINT NAME AND TITLE TOM MATTSON, DIRECTOR OF PUBLIC WORKS	DATE 3/30/22
--------------------------------------------------------------------------------------------------	---------------------------------------------------------------	-----------------

WE, THE UNDERSIGNED CONTRACTOR, HAVE GIVEN CAREFUL CONSIDERATION TO THIS CHANGE PROPOSED AND AGREE, IF THIS PROPOSAL IS APPROVED, THAT WE WILL PROVIDE ALL EQUIPMENT, FURNISH ALL MATERIALS, EXCEPT AS MAY OTHERWISE BE NOTED ABOVE, AND PERFORM ALL SERVICES NECESSARY FOR THE WORK ABOVE SPECIFIED, AND WILL ACCEPT AS FULL PAYMENT, THEREFORE, THE PRICES SHOWN ABOVE. **NOTE: IF YOU, THE CONTRACTOR, DO NOT SIGN ACCEPTANCE OF THIS ORDER, YOUR ATTENTION IS DIRECTED TO THE REQUIREMENTS OF THE SPECIFICATION AS TO PROCEEDING WITH THE ORDERED WORK AND FILING A WRITTEN PROTEST WITHIN THE TIME THEREIN SPECIFIED.**

CONTRACTOR ACCEPTANCE BY:

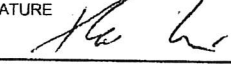
SIGNATURE 	PRINT NAME AND TITLE RAY WILCOX, PRESIDENT	DATE 3-30-22
--------------------------------------------------------------------------------------------------	-----------------------------------------------	-----------------

CONTRACT CHANGE ORDER NUMBER	3	SUPPL. NO.	
------------------------------	---	------------	--

DATE PREPARED BY RESIDENT ENGINEER: March 29, 2022

PROJECT NAME: STORM DAMAGE REPAIR TO PUMA DRIVE (4A125) AT PM 0.10

PROJECT NO. FEMA 4434-DR-CA PW-212 CONTRACT NO. 219342

TO: GR WILCOX ENTERPRISES, INC., P.O. BOX 186, WHITETHORN, CA 95589

YOU ARE HEREBY DIRECTED TO MAKE THE HEREIN DESCRIBED CHANGES FROM THE PLANS AND SPECIFICATIONS OR TO DO THE FOLLOWING DESCRIBED WORK NOT INCLUDED IN THE PLANS AND SPECIFICATIONS FOR THIS CONTRACT. **NOTE THIS CHANGE ORDER IS NOT EFFECTIVE UNTIL APPROVED BY THE DIRECTOR OF PUBLIC WORKS**

DESCRIPTION OF WORK TO BE DONE, ESTIMATE OF QUANTITIES, AND PRICES PAID. (SEGREGATE BETWEEN ADDITIONAL WORK AT CONTRACT PRICE, AGREED PRICE AND FORCE ACCOUNT.) UNLESS OTHERWISE STATED, RATES FOR RENTAL OF EQUIPMENT COVER ONLY SUCH TIME AS EQUIPMENT IS ACTUALLY USED AND NO ALLOWANCE WILL BE MADE FOR IDLE TIME. THE LAST PERCENTAGE SHOWN IS THE NET ACCUMULATED INCREASE OR DECREASE FROM THE ORIGINAL QUANTITY IN THE ENGINEER'S ESTIMATE.

EXTRA WORK AT AGREED PRICE:

Reconstruct embankment at outlet of temporary culvert. \$ 15,000.00

For this work, the contractor shall receive and accept the agreed lump sum of **\$15,000.00** for reconstructing embankment. This sum constitutes full and complete compensation for furnishing all labor, material, equipment, tools, and incidentals including all markups by reason of this change.

A determination of the delay in completion of the project due to the work specified in this change order has been made in accordance with Section 8-1.02, Schedule, and Section 8-1.07, Delay, of the *Standard Specifications*. An extension of one (1) working day shall be granted for change order work performed on 2/4/2022.

ESTIMATED TOTAL INCREASE = \$ 15,000.00

BY REASON OF THIS CHANGE, THE CONTRACT TIME WILL BE INCREASED BY 1 WORKING DAYS

SUBMITTED BY:

SIGNATURE 	PRINT NAME AND TITLE ANGI SORENSEN, CONSTRUCTION ENGINEER	DATE 3-30-2022
--------------------------------------------------------------------------------------------------	--------------------------------------------------------------	-------------------

DIRECTOR APPROVAL BY:

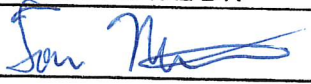
SIGNATURE 	PRINT NAME AND TITLE TOM MATTSON, DIRECTOR OF PUBLIC WORKS	DATE 3/30/22
--------------------------------------------------------------------------------------------------	---------------------------------------------------------------	-----------------

WE, THE UNDERSIGNED CONTRACTOR, HAVE GIVEN CAREFUL CONSIDERATION TO THIS CHANGE PROPOSED AND AGREE, IF THIS PROPOSAL IS APPROVED, THAT WE WILL PROVIDE ALL EQUIPMENT, FURNISH ALL MATERIALS, EXCEPT AS MAY OTHERWISE BE NOTED ABOVE, AND PERFORM ALL SERVICES NECESSARY FOR THE WORK ABOVE SPECIFIED, AND WILL ACCEPT AS FULL PAYMENT, THEREFORE, THE PRICES SHOWN ABOVE. **NOTE: IF YOU, THE CONTRACTOR, DO NOT SIGN ACCEPTANCE OF THIS ORDER, YOUR ATTENTION IS DIRECTED TO THE REQUIREMENTS OF THE SPECIFICATION AS TO PROCEEDING WITH THE ORDERED WORK AND FILING A WRITTEN PROTEST WITHIN THE TIME THEREIN SPECIFIED.**

CONTRACTOR ACCEPTANCE BY:

SIGNATURE 	PRINT NAME AND TITLE RAY WILCOX President	DATE 3-30-22
--------------------------------------------------------------------------------------------------	----------------------------------------------	-----------------

CONTRACT CHANGE ORDER

CONTRACT CHANGE ORDER NUMBER	1	SUPPL. NO.	
DATE PREPARED BY RESIDENT ENGINEER: February 28, 2023			
PROJECT NAME: STORM DAMAGE REPAIR TO PUMA DRIVE (4A125) AT PM 0.21			
PROJECT NO.	FEMA 4434-DR-CA PW-212	CONTRACT NO.	219343
TO: GR WILCOX ENTERPRISES, INC., P.O. BOX 186, WHITETHORN, CA 95589			

YOU ARE HEREBY DIRECTED TO MAKE THE HEREIN DESCRIBED CHANGES FROM THE PLANS AND SPECIFICATIONS OR TO DO THE FOLLOWING DESCRIBED WORK NOT INCLUDED IN THE PLANS AND SPECIFICATIONS FOR THIS CONTRACT. NOTE THIS CHANGE ORDER IS NOT EFFECTIVE UNTIL APPROVED BY THE DIRECTOR OF PUBLIC WORKS

DESCRIPTION OF WORK TO BE DONE, ESTIMATE OF QUANTITIES, AND PRICES PAID. (SEGREGATE BETWEEN ADDITIONAL WORK AT CONTRACT PRICE, AGREED PRICE AND FORCE ACCOUNT.) UNLESS OTHERWISE STATED, RATES FOR RENTAL OF EQUIPMENT COVER ONLY SUCH TIME AS EQUIPMENT IS ACTUALLY USED AND NO ALLOWANCE WILL BE MADE FOR IDLE TIME. THE LAST PERCENTAGE SHOWN IS THE NET ACCUMULATED INCREASE OR DECREASE FROM THE ORIGINAL QUANTITY IN THE ENGINEER'S ESTIMATE.

Eliminate roadway restoration work at Puma Drive P.M. 0.21.

DECREASE IN CONTRACT ITEMS AT CONTRACT PRICES

ITEM NO. 2	CONSTRUCTION AREA SIGNS	-1 EA	-100.00%	@	\$ 225.00 / EA	\$ (225.00)
ITEM NO. 3	TRAFFIC CONTROL SYSTEM	-0.1 LS	-100.00%	@	\$ 7,238.00 / LS	\$ (723.80)
ITEM NO. 5	JOBSITE MANAGEMENT	-0.1 LS	-100.00%	@	\$ 25,476.00 / LS	\$ (2,547.60)
ITEM NO. 11	ROADWAY EXCAVATION	-50 CY	-100.00%	@	\$ 34.80 / CY	\$ (1,740.00)
ITEM NO. 24	HOT MIX ASPHALT (TYPE A)	-8 TN	-100.00%	@	\$ 275.00 / TN	\$ (2,200.00)
ITEM NO. 49	PAINT TRAFFIC STRIPE (2 COAT)	-200.00 LF	-100.00%	@	\$ 13.12 / LF	\$ (2,624.00)
TOTAL DECREASE = \$ (10,060.40)						

In accordance with Section 9-1.06D, "Eliminated Items," of the *Standard Specifications*, the adjustment due to the elimination of the above items is zero.

A determination of the delay in completion of the project due to the work specified in this change order has been made in accordance with Section 8-1.02, Schedule, and Section 8-1.07, Delay, of the *Standard Specifications*. These changes did not delay controlling activities; therefore, no time extension is granted.

ESTIMATED TOTAL DECREASE = \$(10,060.40)

BY REASON OF THIS CHANGE, THE CONTRACT TIME WILL BE INCREASED BY 0 DAYS

SUBMITTED BY:

SIGNATURE 	PRINT NAME AND TITLE ANGI SORENSEN, CONSTRUCTION ENGINEER	DATE 6/5/23
--------------------------------------------------------------------------------------------------	--------------------------------------------------------------	----------------

DIRECTOR APPROVAL BY:

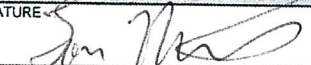
SIGNATURE 	PRINT NAME AND TITLE TOM MATTSO, DIRECTOR OF PUBLIC WORKS	DATE 6/5/23
--------------------------------------------------------------------------------------------------	--------------------------------------------------------------	----------------

WE, THE UNDERSIGNED CONTRACTOR, HAVE GIVEN CAREFUL CONSIDERATION TO THIS CHANGE PROPOSED AND AGREE, IF THIS PROPOSAL IS APPROVED, THAT WE WILL PROVIDE ALL EQUIPMENT, FURNISH ALL MATERIALS, EXCEPT AS MAY OTHERWISE BE NOTED ABOVE, AND PERFORM ALL SERVICES NECESSARY FOR THE WORK ABOVE SPECIFIED, AND WILL ACCEPT AS FULL PAYMENT, THEREFORE, THE PRICES SHOWN ABOVE. NOTE: IF YOU, THE CONTRACTOR, DO NOT SIGN ACCEPTANCE OF THIS ORDER, YOUR ATTENTION IS DIRECTED TO THE REQUIREMENTS OF THE SPECIFICATION AS TO PROCEEDING WITH THE ORDERED WORK AND FILING A WRITTEN PROTEST WITHIN THE TIME THEREIN SPECIFIED.

CONTRACTOR ACCEPTANCE BY:

SIGNATURE 	PRINT NAME AND TITLE RAY WILCOX, President	DATE 6-5-23
--------------------------------------------------------------------------------------------------	-----------------------------------------------	----------------

CONTRACT CHANGE ORDER NUMBER	1	SUPPL. NO.	
------------------------------	---	------------	--

DATE PREPARED BY RESIDENT ENGINEER: March 16, 2022

PROJECT NAME: STORM DAMAGE REPAIR TO PUMA DRIVE (4A125) AT PM 0.25

PROJECT NO. FEMA 4308-DR-CA PW-1309 CONTRACT NO. 217541

TO: GR WILCOX ENTERPRISES, INC., P.O. BOX 186, WHITETHORN, CA 95589

YOU ARE HEREBY DIRECTED TO MAKE THE HEREIN DESCRIBED CHANGES FROM THE PLANS AND SPECIFICATIONS OR TO DO THE FOLLOWING DESCRIBED WORK NOT INCLUDED IN THE PLANS AND SPECIFICATIONS FOR THIS CONTRACT. **NOTE THIS CHANGE ORDER IS NOT EFFECTIVE UNTIL APPROVED BY THE DIRECTOR OF PUBLIC WORKS**

DESCRIPTION OF WORK TO BE DONE, ESTIMATE OF QUANTITIES, AND PRICES PAID. (SEGREGATE BETWEEN ADDITIONAL WORK AT CONTRACT PRICE, AGREED PRICE AND FORCE ACCOUNT.) UNLESS OTHERWISE STATED, RATES FOR RENTAL OF EQUIPMENT COVER ONLY SUCH TIME AS EQUIPMENT IS ACTUALLY USED AND NO ALLOWANCE WILL BE MADE FOR IDLE TIME. THE LAST PERCENTAGE SHOWN IS THE NET ACCUMULATED INCREASE OR DECREASE FROM THE ORIGINAL QUANTITY IN THE ENGINEER'S ESTIMATE.

INCREASE IN CONTRACT ITEM AT CONTRACT PRICE

ITEM NO. 18	ROLLED EROSION CONTROL PRODUCT (BLANKET)					
	170 SY	N/A	@	\$ 11.76 / SY		\$ 1,999.20
ITEM NO. 31	18" PLASTIC PIPE (HEAT-FUSED HDPE)					
	29 LF	8.53%	@	\$ 124.17 / LF		\$ 3,600.93
ITEM NO. 43	ROCK SLOPE PROTECTION (1/4 T, CLASS V, METHOD B) (CY)					
	24 CY	300.00%	@	\$ 176.84 / CY		\$ 4,244.16
TOTAL INCREASE =						\$ 9,844.29

No adjustment to contract unit price for Item 43, Rock Slope Protection (1/4 T, Class V, Method B) (CY), will be made in accordance with Section 9-1.06B, "Increases of More Than 25 Percent," of the *Standard Specifications* by reason of this change order.

DECREASE IN CONTRACT ITEMS AT CONTRACT PRICES

ITEM NO. 2	CONSTRUCTION AREA SIGNS					
	-1 EA	-100.00%	@	\$ 225.00 / EA		\$ (225.00)
ITEM NO. 17	DRY SEED					
	-280 SF	-8.28%	@	\$ 0.66 / SF		\$ (184.80)
ITEM NO. 20	STRAW					
	-1780 SF	-52.66%	@	\$ 0.56 / SF		\$ (996.80)
ITEM NO. 24	HOT MIX ASPHALT (TYPE A)					
	-3 TN	-21.43%	@	\$ 275.00 / TN		\$ (825.00)
ITEM NO. 44	MISCELLANEOUS METAL (INLET GRATE, 24-12X GALVANIZED)					
	-62 LB	-12.97%	@	\$ 4.24 / LB		\$ (262.88)
ITEM NO. 49	PAINT TRAFFIC STRIPE (2 COAT)					
	-30.00 LF	-100.00%	@	\$ 13.12 / LF		\$ (393.60)
TOTAL DECREASE =						\$ (2,888.08)

In accordance with Section 9-1.06D, "Eliminated Items," of the *Standard Specifications*, the adjustment due to the elimination of Item No. 2, Construction Area Signs, and Item No. 49, Paint Traffic Stripe (2 Coat), is zero.

A determination of the delay in completion of the project due to the work specified in this change order has been made in accordance with Section 8-1.02, Schedule, and Section 8-1.07, Delay, of the *Standard Specifications*. These changes did not delay controlling activities; therefore, no time extension is granted.

ESTIMATED TOTAL INCREASE = \$ 6,956.21

BY REASON OF THIS CHANGE, THE CONTRACT TIME WILL BE INCREASED BY 0 DAYS

SUBMITTED BY:

SIGNATURE 	PRINT NAME AND TITLE ANGI SORENSEN, CONSTRUCTION ENGINEER	DATE 3-28-2022
------------------------------------------------------------------------------------------------	--------------------------------------------------------------	-------------------

DIRECTOR APPROVAL BY:

SIGNATURE 	PRINT NAME AND TITLE TOM MATTSON, DIRECTOR OF PUBLIC WORKS	DATE 3/24/22
------------------------------------------------------------------------------------------------	---------------------------------------------------------------	-----------------

WE, THE UNDERSIGNED CONTRACTOR, HAVE GIVEN CAREFUL CONSIDERATION TO THIS CHANGE PROPOSED AND AGREE, IF THIS PROPOSAL IS APPROVED, THAT WE WILL PROVIDE ALL EQUIPMENT, FURNISH ALL MATERIALS, EXCEPT AS MAY OTHERWISE BE NOTED ABOVE, AND PERFORM ALL SERVICES NECESSARY FOR THE WORK ABOVE SPECIFIED, AND WILL ACCEPT AS FULL PAYMENT, THEREFORE, THE PRICES SHOWN ABOVE. **NOTE: IF YOU, THE CONTRACTOR, DO NOT SIGN ACCEPTANCE OF THIS ORDER, YOUR ATTENTION IS DIRECTED TO THE REQUIREMENTS OF THE SPECIFICATION AS TO PROCEEDING WITH THE ORDERED WORK AND FILING A WRITTEN PROTEST WITHIN THE TIME THEREIN SPECIFIED.**

CONTRACTOR ACCEPTANCE BY:

SIGNATURE 	PRINT NAME AND TITLE RAY WILCOX, PRESIDENT	DATE 3-28-22
------------------------------------------------------------------------------------------------	-----------------------------------------------	-----------------

CONTRACT CHANGE ORDER NUMBER	2	SUPPL. NO.	
------------------------------	---	------------	--

DATE PREPARED BY RESIDENT ENGINEER: March 29, 2022

PROJECT NAME: STORM DAMAGE REPAIR TO PUMA DRIVE (4A125) AT PM 0.25

PROJECT NO. FEMA 4308-DR-CA PW-1309 CONTRACT NO. 217541

TO: GR WILCOX ENTERPRISES, INC., P.O. BOX 186, WHITETHORN, CA 95589

YOU ARE HEREBY DIRECTED TO MAKE THE HEREIN DESCRIBED CHANGES FROM THE PLANS AND SPECIFICATIONS OR TO DO THE FOLLOWING DESCRIBED WORK NOT INCLUDED IN THE PLANS AND SPECIFICATIONS FOR THIS CONTRACT. **NOTE THIS CHANGE ORDER IS NOT EFFECTIVE UNTIL APPROVED BY THE DIRECTOR OF PUBLIC WORKS**

DESCRIPTION OF WORK TO BE DONE, ESTIMATE OF QUANTITIES, AND PRICES PAID. (SEGREGATE BETWEEN ADDITIONAL WORK AT CONTRACT PRICE, AGREED PRICE AND FORCE ACCOUNT.) UNLESS OTHERWISE STATED, RATES FOR RENTAL OF EQUIPMENT COVER ONLY SUCH TIME AS EQUIPMENT IS ACTUALLY USED AND NO ALLOWANCE WILL BE MADE FOR IDLE TIME. THE LAST PERCENTAGE SHOWN IS THE NET ACCUMULATED INCREASE OR DECREASE FROM THE ORIGINAL QUANTITY IN THE ENGINEER'S ESTIMATE.

EXTRA WORK AT AGREED PRICE

Connect existing 8" underdrain to new drainage inlet. \$ 1,700.00

For this work, the contractor shall receive and accept the agreed lump sum of **\$1,700.00** for connecting existing underdrain to new drainage inlet. This sum constitutes full and complete compensation for furnishing all labor, material, equipment, tools, and incidentals including all markups by reason of this change.

A determination of the delay in completion of the project due to the work specified in this change order has been made in accordance with Section 8-1.02, Schedule, and Section 8-1.07, Delay, of the *Standard Specifications*. An extension of one (1) working day shall be granted for change order work performed on 11/12/2021.

ESTIMATED TOTAL INCREASE = \$ 1,700.00

BY REASON OF THIS CHANGE, THE CONTRACT TIME WILL BE INCREASED BY 1 WORKING DAYS

SUBMITTED BY:

SIGNATURE 	PRINT NAME AND TITLE ANGI SORENSEN, CONSTRUCTION ENGINEER	DATE 3/30/2022
--------------------------------------------------------------------------------------------------	--------------------------------------------------------------	-------------------

DIRECTOR APPROVAL BY:

SIGNATURE 	PRINT NAME AND TITLE TOM MATTSON, DIRECTOR OF PUBLIC WORKS	DATE 3/30/22
--------------------------------------------------------------------------------------------------	---------------------------------------------------------------	-----------------

WE, THE UNDERSIGNED CONTRACTOR, HAVE GIVEN CAREFUL CONSIDERATION TO THIS CHANGE PROPOSED AND AGREE, IF THIS PROPOSAL IS APPROVED, THAT WE WILL PROVIDE ALL EQUIPMENT, FURNISH ALL MATERIALS, EXCEPT AS MAY OTHERWISE BE NOTED ABOVE, AND PERFORM ALL SERVICES NECESSARY FOR THE WORK ABOVE SPECIFIED, AND WILL ACCEPT AS FULL PAYMENT, THEREFORE, THE PRICES SHOWN ABOVE. **NOTE: IF YOU, THE CONTRACTOR, DO NOT SIGN ACCEPTANCE OF THIS ORDER, YOUR ATTENTION IS DIRECTED TO THE REQUIREMENTS OF THE SPECIFICATION AS TO PROCEEDING WITH THE ORDERED WORK AND FILING A WRITTEN PROTEST WITHIN THE TIME THEREIN SPECIFIED.**

CONTRACTOR ACCEPTANCE BY:

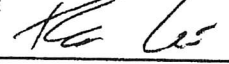
SIGNATURE 	PRINT NAME AND TITLE RAY WILCOX PRESIDENT	DATE 3-30-22
--------------------------------------------------------------------------------------------------	----------------------------------------------	-----------------

CONTRACT CHANGE ORDER NUMBER	1	SUPPL. NO.	
------------------------------	---	------------	--

DATE PREPARED BY RESIDENT ENGINEER: February 28, 2022

PROJECT NAME: STORM DAMAGE REPAIR TO PUMA DRIVE (4A125) AT PM 0.60

PROJECT NO. FEMA 4434-DR-CA PW-212 CONTRACT NO. 219346

TO: GR WILCOX ENTERPRISES, INC., P.O. BOX 186, WHITETHORN, CA 95589

YOU ARE HEREBY DIRECTED TO MAKE THE HEREIN DESCRIBED CHANGES FROM THE PLANS AND SPECIFICATIONS OR TO DO THE FOLLOWING DESCRIBED WORK NOT INCLUDED IN THE PLANS AND SPECIFICATIONS FOR THIS CONTRACT. **NOTE THIS CHANGE ORDER IS NOT EFFECTIVE UNTIL APPROVED BY THE DIRECTOR OF PUBLIC WORKS**

DESCRIPTION OF WORK TO BE DONE, ESTIMATE OF QUANTITIES, AND PRICES PAID. (SEGREGATE BETWEEN ADDITIONAL WORK AT CONTRACT PRICE, AGREED PRICE AND FORCE ACCOUNT.) UNLESS OTHERWISE STATED, RATES FOR RENTAL OF EQUIPMENT COVER ONLY SUCH TIME AS EQUIPMENT IS ACTUALLY USED AND NO ALLOWANCE WILL BE MADE FOR IDLE TIME. THE LAST PERCENTAGE SHOWN IS THE NET ACCUMULATED INCREASE OR DECREASE FROM THE ORIGINAL QUANTITY IN THE ENGINEER'S ESTIMATE.

INCREASE IN CONTRACT ITEMS AT CONTRACT UNIT PRICES

ITEM NO. 11 ROADWAY EXCAVATION						
2 CY	0.87%	@	\$ 34.80 / CY		\$	69.60
ITEM NO. 13 CLASS 2 AGGREGATE BASE (CY)						
12 CY	6.22%	@	\$ 98.16 / CY		\$	1,177.92
TOTAL INCREASE =						\$ 1,247.52

DECREASE IN CONTRACT ITEMS AT CONTRACT UNIT PRICES

ITEM NO. 2 CONSTRUCTION AREA SIGNS						
-1 EA	-100.00%	@	\$ 225.00 / EA		\$	(225.00)
ITEM NO. 49 PAINT TRAFFIC STRIPE (2 COAT)						
-290 LF	-100.00%	@	\$ 13.12 / LF		\$	(3,804.80)
TOTAL DECREASE =						\$ (4,029.80)

In accordance with Section 9-1.06D, "Eliminated Items," of the *Standard Specifications*, the adjustment due to the elimination of Item No. 2, Construction Area Signs, and Item No. 49, Paint Traffic Stripe (2 Coat), is zero.

A determination of the delay in completion of the project due to the work specified in this change order has been made in accordance with Section 8-1.02, Schedule, and Section 8-1.07, Delay, of the *Standard Specifications*. These changes did not delay controlling activities; therefore, no time extension is granted.

ESTIMATED TOTAL DECREASE = \$ (2,782.28)

BY REASON OF THIS CHANGE, THE CONTRACT TIME WILL BE INCREASED BY 0 DAYS

SUBMITTED BY:

SIGNATURE 	PRINT NAME AND TITLE ANGI SORENSEN, CONSTRUCTION ENGINEER	DATE 3-28-2022
--------------------------------------------------------------------------------------------------	--------------------------------------------------------------	-------------------

DIRECTOR APPROVAL BY:

SIGNATURE 	PRINT NAME AND TITLE TOM MATTSON, DIRECTOR OF PUBLIC WORKS	DATE 3/28/22
--------------------------------------------------------------------------------------------------	---------------------------------------------------------------	-----------------

WE, THE UNDERSIGNED CONTRACTOR, HAVE GIVEN CAREFUL CONSIDERATION TO THIS CHANGE PROPOSED AND AGREE, IF THIS PROPOSAL IS APPROVED, THAT WE WILL PROVIDE ALL EQUIPMENT, FURNISH ALL MATERIALS, EXCEPT AS MAY OTHERWISE BE NOTED ABOVE, AND PERFORM ALL SERVICES NECESSARY FOR THE WORK ABOVE SPECIFIED, AND WILL ACCEPT AS FULL PAYMENT, THEREFORE, THE PRICES SHOWN ABOVE. **NOTE: IF YOU, THE CONTRACTOR, DO NOT SIGN ACCEPTANCE OF THIS ORDER, YOUR ATTENTION IS DIRECTED TO THE REQUIREMENTS OF THE SPECIFICATION AS TO PROCEEDING WITH THE ORDERED WORK AND FILING A WRITTEN PROTEST WITHIN THE TIME THEREIN SPECIFIED.**

CONTRACTOR ACCEPTANCE BY:

SIGNATURE 	PRINT NAME AND TITLE RAY WILCOX PRESIDENT	DATE 3-28-22
--------------------------------------------------------------------------------------------------	----------------------------------------------	-----------------